

**\$8.95**

Suggested Retail Price

-- Welcome to --

# The Ref <sup>(tm)</sup>

**GUIDE TO HARD DRIVES, FLOPPY DRIVES, OPTICAL DRIVES,  
DRIVE CONTROLLERS & HOST ADAPTERS.**

# Ver. 4.3

Copyright 1989, 1994 by F.Robert Falbo

<< All Rights Reserved >>

TheRef (tm) is a trademark of F.Robert Falbo  
This document is Copyright 1994 by F.Robert Falbo,  
**ALL RIGHTS RESERVED**

**Published By : Paper Works Computers**

P.O. BOX 9393

ALLENTOWN, PA 18105 - 9393

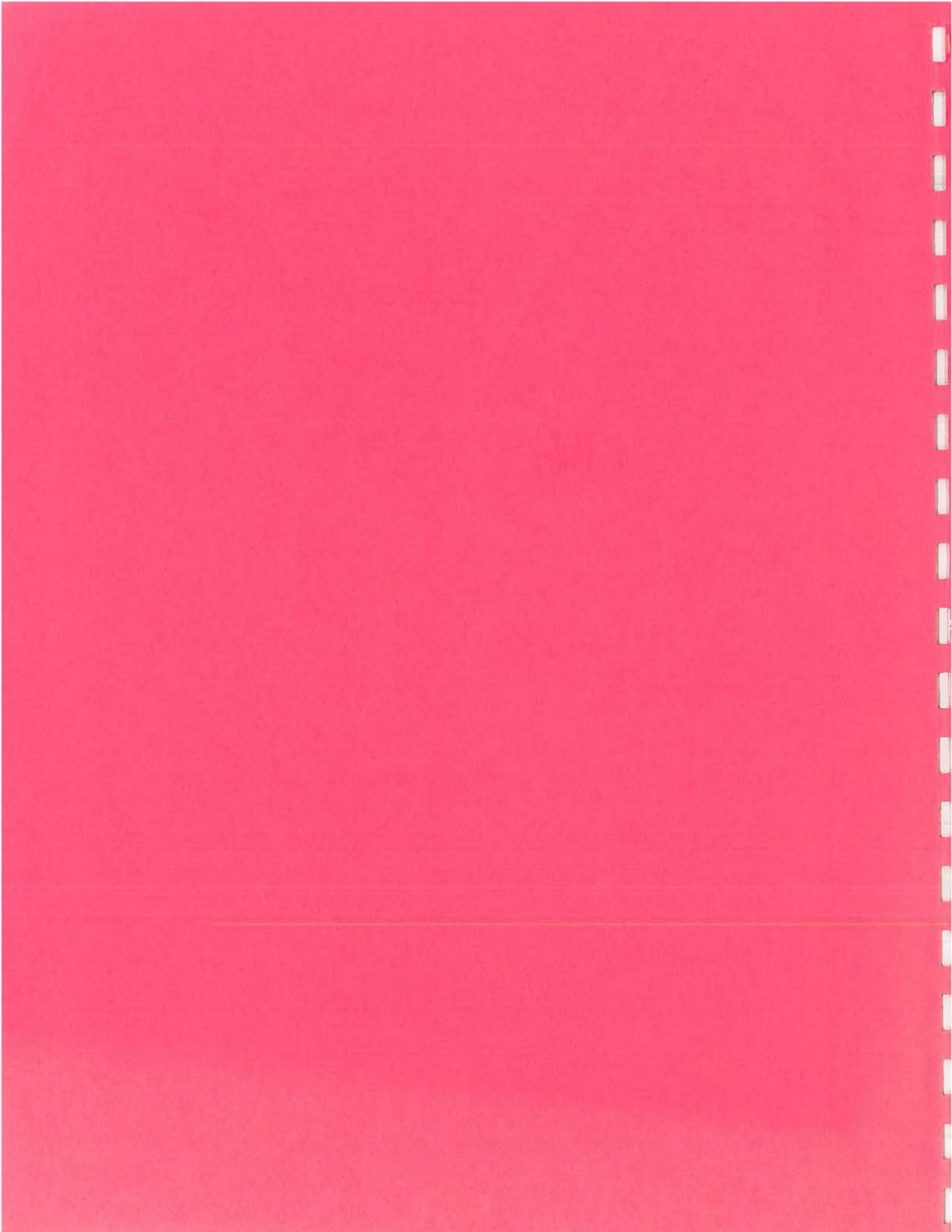

# Table Of Contents

## Section One

### **Diagrams**

## Section Two

### **Controller Layouts**

## Section Three

### **Controller Specs**

## Section Four

### **Floppy Drive Specs**

## Section Five

### **Hard Drive Specs**

## Section Six

### **Optical Drive Specs**

## Section Seven

### **Manufacturer Directory**

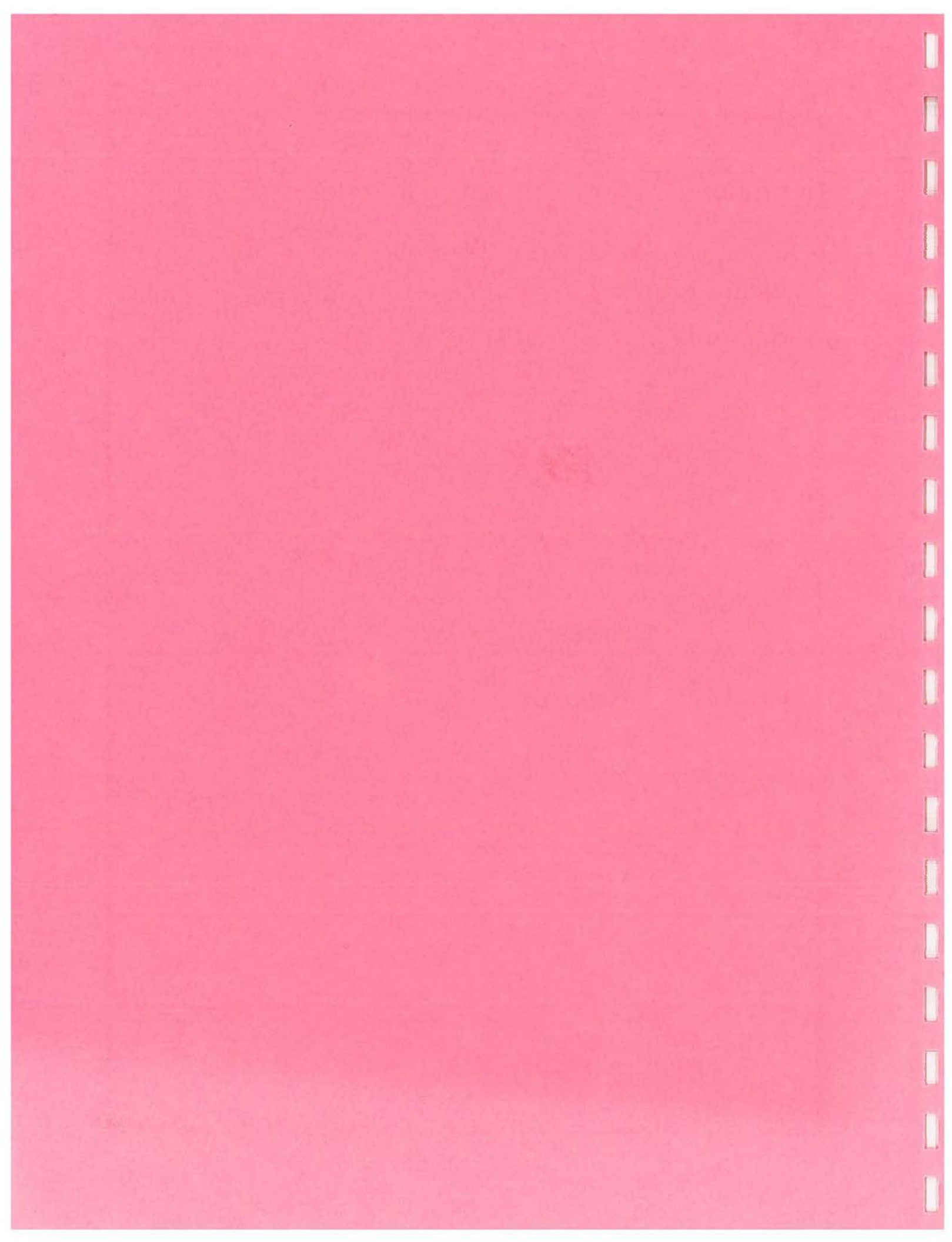

# Diagrams

Floppy Cables

Hard Drive Cables

Terminators

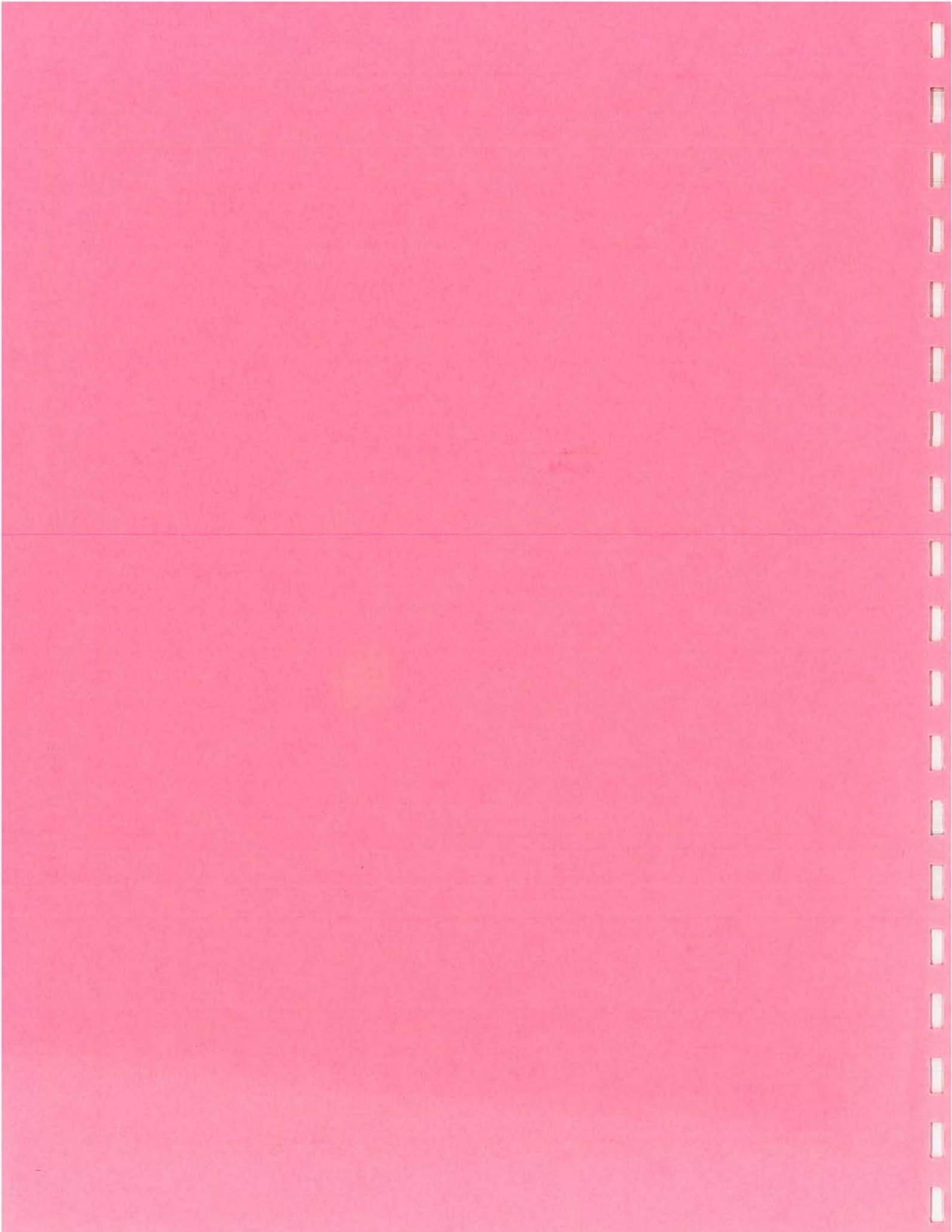

In "publishing" TheRef(tm), I've often been asked the difference between the types of drive controllers and recording methods. I'm not going to get into that in this document, as it would require a good sized doc. of it's own. What I have supplied are diagrams of the different connectors associated with the technology today.

frf

CABLES

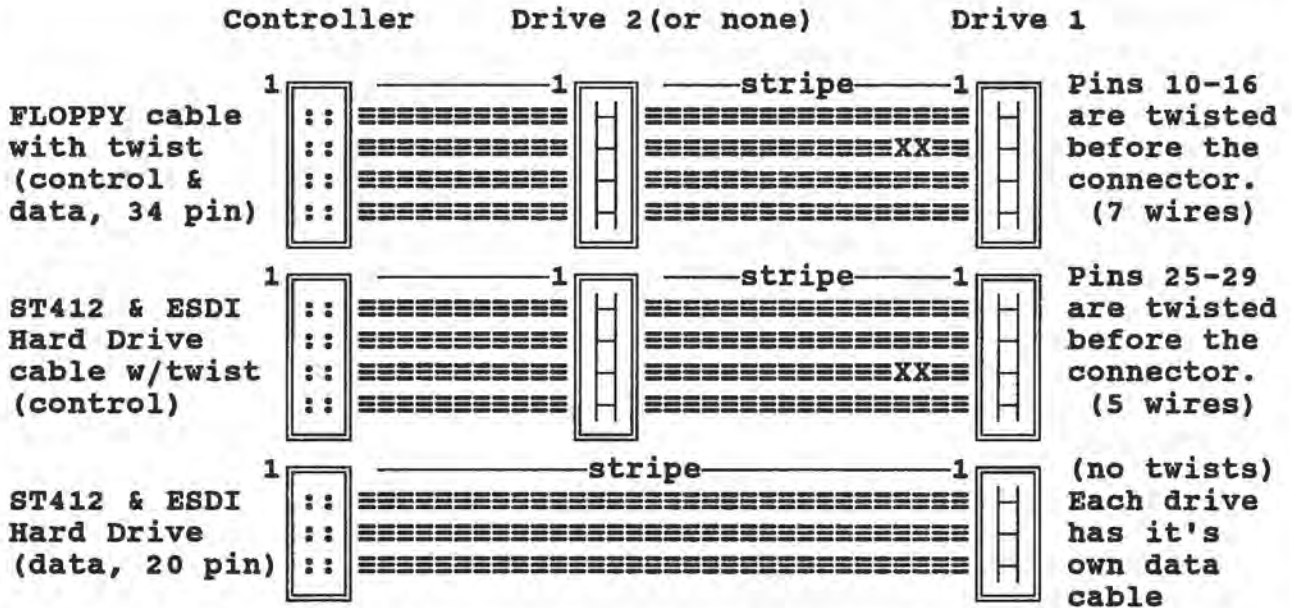

**IMPORTANT NOTE:** Pin #1 on any drive cable SHOULD be indicated by a colored stripe. If you should find the stripe by connector pin 34 (or 20), inspect the whole cable VERY thoroughly!

**DRIVE SELECT JUMPERS:** For both Floppy and Hard drives, when the 34 pin cable has a twist, the device number should be set to the second position. Drives numbered 0-3, set to 1, those numbered 1-4, set to 2. When cables without a twist are used, Floppy "A", and(or) Hard drive "C" should be set to 1, and the second Floppy and (or) Hard drive should be set to 2.

**TERMINATORS:** When using more than one drive on a cable (ie; 2FDs or 2HDs), the terminating resistor pack should be left on the drive furthest from the controller, and removed from the drive closest to the controller.

**NOTE:** On SCSI drives, the Host Adapter also has resistors. These are needed to terminate both ends of the bus. Since the SCSI bus can have up to 7 devices attached to it, only the Host Adapter and the device farthest from it will retain the resistors. All devices in-between should have theirs removed.

CONNECTIONS

FLOPPY DRIVES

The connector on a floppy drive consists of 34 conductors. Both control and data use this same cable. Most cables have a twist that interchanges pins 10 through 16 at the end of the cable (on drive 1). Most floppy connectors have a "key" between pins 4 & 6, and 3 & 5, to prevent the cable from being reversed. At the other end, the dual row connector that attaches to the controller card will usually have a set of ridges that coincide with cutouts in the controller card's connector. Note that old style floppy-only controllers used a card-edge connector just like that of the drive.

HI/LO DENSITY >	2	1	GND
N/C	4	3	
N/C	6	5	
INDEX <	8	7	
MOTOR ENAB. A >	10	9	
DRIVE SEL. B >	12	11	
DRIVE SEL. A >	14	13	
MOTOR ENAB. B >	16	15	
DIRECTION SEL. >	18	17	
HEAD STEP >	20	19	
WRITE DATA >	22	21	
WRITE GATE >	24	23	
TRACK 00 <	26	25	
WRITE PROTECT <	28	27	
READ DATA <	30	29	
HEAD SELECT >	32	31	
DISK CHANGE <	34	33	GND

> Input ( At the Drive Conn.)  
< Output

ST506/412 HARD DRIVE (MFM & RLL)

This standard drive system uses two cables; a 34 conductor control cable, and a 20 conductor data cable. The control cable contains a twist of the conductors going to the farthest drive, which is drive "C" on most systems. This twist consists of conductors 25 through 29. As with the floppy cable, the ST506/412 cables normally have a key to prevent reversal, and the controller end has a pin-type connector, while the drive end has a card-edge type connector.

HEAD SEL. 8	2	1	GND
HEAD SEL. 4	4	3	
WRITE GATE	6	5	
SEEK COMPLETE	8	7	
TRACK 0	10	9	
WRITE FAULT	12	11	
HEAD SEL. 1	14	13	
RESERVED	16	15	
HEAD SEL. 2	18	17	
INDEX	20	19	
READY	22	21	
STEP	24	23	
DRIVE SEL. 1	26	25	
DRIVE SEL. 2	28	27	
DRIVE SEL. 3	30	29	
DRIVE SEL. 4	32	31	
DIRECTION IN	34	33	GND

DRIVE SEL'D	1	2	GND
RESERVED	3	4	
	5	6	
	7	8	GND
RESERVED	9	10	RESERVED
GND	11	12	GND
* WRITE DATA+	13	14	* WRITE DATA-
GND	15	16	GND
* READ DATA+	17	18	* READ DATA-
GND	19	20	GND

\*(MFM or RLL)

Though control signals go through a single 34 conductor cable, data flows through separate 20 conductor cables for each drive (C,D).



## CONNECTIONS

## ESDI HARD DRIVES

Though ESDI and ST506/412 drives share similar looking cables, even to the point of having a twist, the actual data and control signals are very different. One should never mix components from these two drive types. While the ST506/412 interface utilizes a standard pulse code to transmit data between the drive and controller, ESDI uses a pulse code that does not require the level to return to zero between pulses. This format is referred to as NRZ, or Non Return to Zero. By utilizing NRZ, the clock that data is transferred by can be increased, thereby increasing the throughput to and from the ESDI disk.

HEAD SEL. 3	2	1	GND
HEAD SEL. 2	4	3	
WRITE GATE	6	5	
CONFIG/STAT DATA	8	7	
TRANSFER ACK.	10	9	
ATTENTION	12	11	
HEAD SEL. 0	14	13	
SECT/ADD.MK. FOUND	16	15	
HEAD SEL. 1	18	17	
INDEX	20	19	
READY	22	21	
TRANS.REQUEST	24	23	
DRIVE SEL. 1	26	25	
DRIVE SEL. 2	28	27	
DRIVE SEL. 3	30	29	
READ GATE	32	31	
COMMAND DATA	34	33	GND

DRIVE SEL'D	1	2	SECT/ADD.MK. FOUND
SEEK COMPLETE	3	4	ADDRESS MARK ENABLE
RESV'D FOR STEP MODE	5	6	GND
WRITE CLOCK+	7	8	WRITE CLOCK-
CARTRIDGE CHANGED	9	10	READ REF. CLOCK+
READ REF. CLOCK-	11	12	GND
NRZ WRITE DATA+	13	14	NRZ WRITE DATA-
GND	15	16	GND
NRZ READ DATA+	17	18	NRZ READ DATA-
GND	19	20	GND

And in this corner... Recording

Times were, you had a simple choice for type of disk drive... Any kind, as long as it was ST506/412. Those were the heydays of MFM drives. But many manufacturers weren't content with the 17 sectors/track that MFM provided. They devised a newer encoding scheme to pack data tighter, and called it RLL, or Run Length Limited, as opposed to MFM, or Modified Frequency Modulation. It involves using groups of 16 bits rather than each individual bit, thus achieving a sort of "compression" of the information as it is encoded. Since the same information takes up less space as RLL encoded data, more info can be written to the disk. The most common RLL technique, known as 2,7 RLL, can pack roughly 50% more on a disk than MFM. Of course, there is always a trade-off, and the timing and media required for RLL is it. RLL requires a higher grade of media because of it's dense bit-packing, and timing is more critical, since the data is flowing at 50% higher rate than an MFM drive. Also, the mechanics of the drive must have tighter

tolerances because head positioning becomes more critical. These requirements kept RLL drives at a premium. It has only been the last two years, that RLL drives have outsold MFM, and have all but wiped them from the marketplace. This turnabout has come from the need to increase disk capacity more and more. Both ESDI, and SCSI type drives utilize RLL.(1\*) encoding to achieve high capacity and transfer rates (from the disk). And the newest interface, IDE, or Integrated Drive Electronics, is also based on this technology.

SCSI HARD DRIVES

The normal internal cable for SCSI is a 50 conductor ribbon, with all odd numbered conductors grounded. Two conductors, numbers 25 & 26, are often left not-connected, as they deal with Terminator power, and can be easily shorted by cable reversals. There are no twists in this cable, and it's length may be a maximum of 6 meters. But one is advised to use minimum lengths to improve timing. Up to seven drives, or devices may be attached to an SCSI cable. Each is daisy-chained on the cable, or, when a device has two connectors, another cable may be "spliced" into the chain starting at the second connector, and continued on. Care must be taken to insure that cables and connectors are not reversed, as this would short pin 26 (TERMPWR) to ground, and likely damage the drive or controller. Also, as explained earlier, the terminating resistors should remain only on the controller (Host Adapter) and the LAST drive on the cable, regardless of it's address.

Most SCSI Host Adapters also have a connector for external drives in the form of a Centronics(tm) type 50 pin, or an "alternate", DB-25F connector. Only the internal 50-pin, and the "alternate" external connector are shown here. (see also: MORE SCSI)

Also, these diagrams refer to the single-ended SCSI connections, since this is the most common arrangement for PCs today. The Differential SCSI requires balanced lines, and is used mostly on high-end workstations.

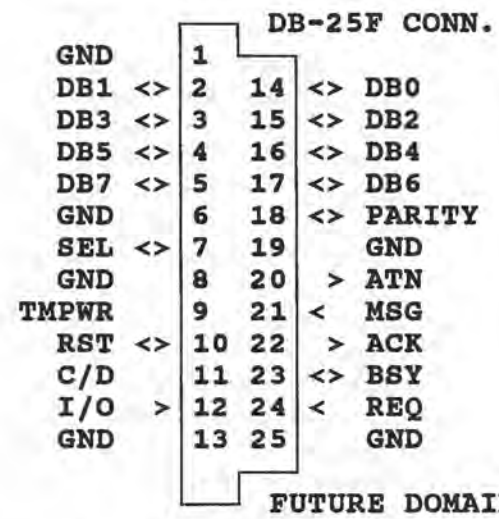
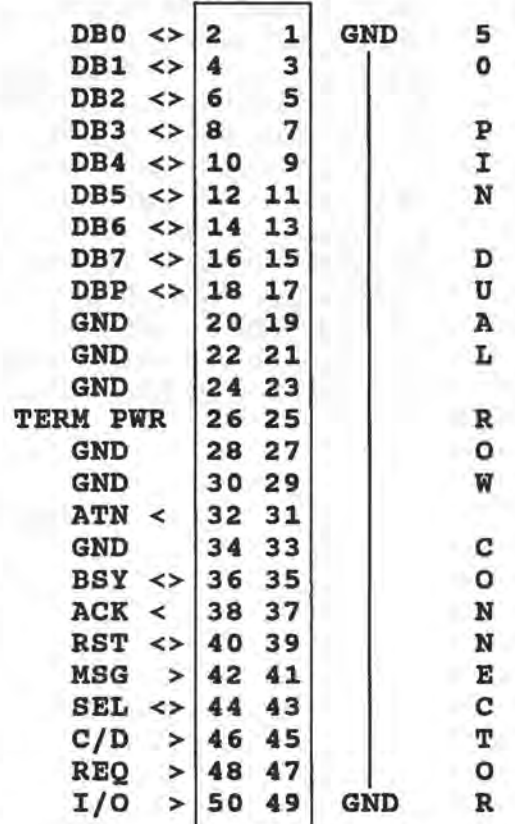

CABLES

SCSI (cont.)

On an SCSI cable, the terminating resistors (T) remain at the END devices on the cable, even when 2 cables are "Daisy-Chained" (DC). Also, the external connector may be used, requiring the removal of the Host Adapter's internal Term. resistors.

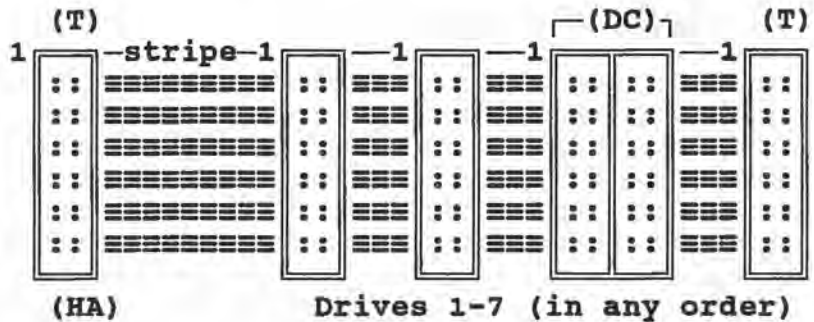

CONNECTORS

IDE (AT) HARD DRIVES

IDE, or Integrated Drive Electronics is the most recent drive interface to gain popularity. Often, the control circuitry is built into the motherboard, eliminating the requirement for a separate Host Adapter. There are 2 types of IDE interfaces...those for the 8-bit XT bus, and those for the 16-bit AT bus (detailed here). The cable for IDE contains 40 conductors and has no twists. Like an SCSI cable, the IDE cable uses a Dual-row Pin connector for both ends. A single cable may be used to connect two drives, or two cables may be Daisy-Chained. Most IDE Host Adapters will support two hard drives. The first drive should be jumpered as the Master drive, and the second as the Slave drive. Plug-in IDE Host Adapters are often called Paddle-Boards, and may contain a floppy controller, and serial and parallel ports.

(<> AT THE DRIVE CONN)

RST	>	1	2	GND
SD7	<>	3	4	<> SD8
SD6	<>	5	6	<> SD9
SD5	<>	7	8	<> SD10
SD4	<>	9	10	<> SD11
SD3	<>	11	12	<> SD12
SD2	<>	13	14	<> SD13
SD1	<>	15	16	<> SD14
SD0	<>	17	18	<> SD15
GND		19	20	N/C (KEY)
RES.N/C		21	22	GND
IOW	>	23	24	GND
IOR	>	25	26	GND
RES.N/C		27	28	N/C RES.
RES.N/C		29	30	GND
IRQ14	<	31	32	> I/O CS16
SA1	<>	33	34	<> PDIAG
SA0	<>	35	36	<> SA2
CS0	>	37	38	< CS1
ACTIVE	<	39	40	GND

CABLES

Note:

The IDE Host Adapter connector may be on a plug-in Paddle-Board or may be integrated on the Motherboard.

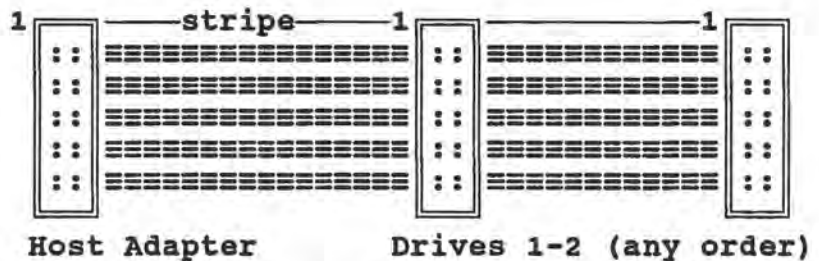

1\* There ARE some SCSI drives that utilize MFM, but very few.

## WRITE PRECOMPENSATION

OK, so we've all seen it listed, and maybe even had to set it in the CMOS. So what IS it? And what does it do?

PreComp. is the way in which the electronics compensates for eventual "drift" of the magnetic domains written on the disk. A simple explanation is that it allows the head to space bits that would attract each other, further apart, while it puts those that repel each other, closer together. It does this by analyzing the data stream, and adjusting the timing for each bit, to allow it to be recorded earlier or later, if needed.

Not all disks require you to set their PreComp value. Those that do are asking for a cylinder to start PreComp. at. Since the packing of the bits on a disk increases as you get closer to the center of the disk (higher cylinders), the requirement for PreComp. increases too. The PreComp. value specified by the Manufacturer for a disk is his way of insuring your long term data stability.

## —&lt; THE EFFECT OF PRECOMPENSATION OVER TIME &gt;—

When recorded (w/o PreComp)	When recorded (with PreComp)
+ -   - +   + -   + -   - +   - +	+ -   - +   + -   - +   - +   - +
After time (w/o PreComp)	After time (with PreComp)
+ -   - +   + - + -   - + - +	+ -   - +   + -   - +   - +   - +

From the figures above, we can see how a slight amount of Pre-Compensation can insure long term stability. The disk that didn't employ PreComp was eventually unreadable. Of course, this would take time to happen, but no one can give cold hard specs on how much drift will occur. (Of course, this example is a gross simplification of the process, but, hey, who's counting?)

| For Notes & Such |

## APPLE SCSI

Unlike in the PC world, the Apple standardized on one drive interface, SCSI. Also, Apple standardized on a 25 pin connector for external connections. However, Apple decided not to implement the complete ANSI spec., so one must be careful that peripherals used are certified to work with Apple's SCSI bus.

Apple also developed it's own pin-configuration. The Apple and Future Domain 25-pin SCSI connectors are as close to "Standards" as there are in the world of PCs. But the real ANSI Standard called for a 50 pin connector commonly referred to as a "Centronics" type (made popular by the Centronics printer company). Instead of the 25 staggered pins of the Apple & Future Domain type connectors, the Centronics type uses 2 parallel rows of 25 pins. This arrangement allows the use of extra grounds for better isolation.

## SCSI HISTORY

SCSI has it's roots in the mainframe world, but it's first implementation in the PC world came soon after the first PC. Shugart Associates devised an interface that they designated the SASI, or "Shugart Associates Standard Interface". They proposed that SASI be adopted by ANSI for small computers, but during the work required for ratification, they discovered the process would take too much effort, and that the IPI groups were already well into their effort. (which had many features the same as SASI) A decision was made to take features of both interfaces, and put forth a new specification for a new interface, SCSI was born, and ratified in 1986 by ANSI. Since then, many have said that the original spec. was not tight enough, and that it allowed Manufacturers to make drives that met the ANSI spec., but would not talk to each other. Recently, the ANSI SCSI committee has proposed newer, tighter, more extended specs., for SCSI-2, and now SCSI-3.

## APPLE DB-25 SCSI

REQ	>	1		
MSG	>	2	14	GND
I/O	>	3	15	< C/D
RST	<>	4	16	GND
ACK	<	5	17	> ATN
BSY	<>	6	18	GND
GND		7	19	<> SEL
DB0	<>	8	20	<> PARITY
GND		9	21	<> DB1
DB3	<>	10	22	<> DB2
DB5	<>	11	23	<> DB4
DB6	<>	12	24	GND
DB7	<>	13	25	TMPWR

GND		1	26	<> DB0
		2	27	<> DB1
		3	28	<> DB2
		4	29	<> DB3
		5	30	<> DB4
		6	31	<> DB5
		7	32	<> DB6
		8	33	<> DB7
		9	34	<> DBP
		10	35	GND
		11	36	GND
		12	37	GND
		13	38	TERM. PWR.
		14	39	GND
		15	40	GND
		16	41	> ATN
		17	42	GND
		18	43	<> BSY
		19	44	> ACK
		20	45	<> RST
		21	46	< MSG
		22	47	<> SEL
		23	48	< C/D
		24	49	< REQ
GND		25	50	< I/O

50 PIN "CENTRONICS"  
FOR "PC" TYPE COMPUTERS

SCSI TERMINATION

With the advent of increased use of SCSI for peripherals comes the chance that one day you'll need an SCSI terminating resistor. Prepare for a shock, because you might be very suprised at the prices charged, for what you get. Many Manufacturers still have SCSI peripheral hardware priced for the Workstation market, not the PC market. We may see these prices erode as more PCs adopt SCSI as their disk interface of choice, but for now be prepared to pay a premium for anything to do with SCSI.

So here you are, with a disk drive mounted internally, and a CDRom hanging off the back of the PC. Everything looks great, but it just doesn't work... Maybe it doesn't even recognize the CDRom. You've checked the connectors, and everything looks good... So what's the problem? Well, did you check the terminators? (Say Whaaat??) Improper termination of an SCSI bus can raise havock with the Host Adapter's interface circuit, and result in missing peripherals, or intermittent operation and possible loss of data.

Well, here's a way to build an inexpensive terminator that will connect to the second SCSI connector on many SCSI peripherals.

All you need is a Male 50-pin Centronics type connector, a small length of wire, and 18 resistors of 330Ω and 18 of 220Ω, 1/4 watt.

The schematic for connecting the resistors & connector is above, and I'll not go any deeper into construction except to say that if you can't take it from here without explanation, you should buy your terminator instead, as you can do too much damage if you do it wrong.

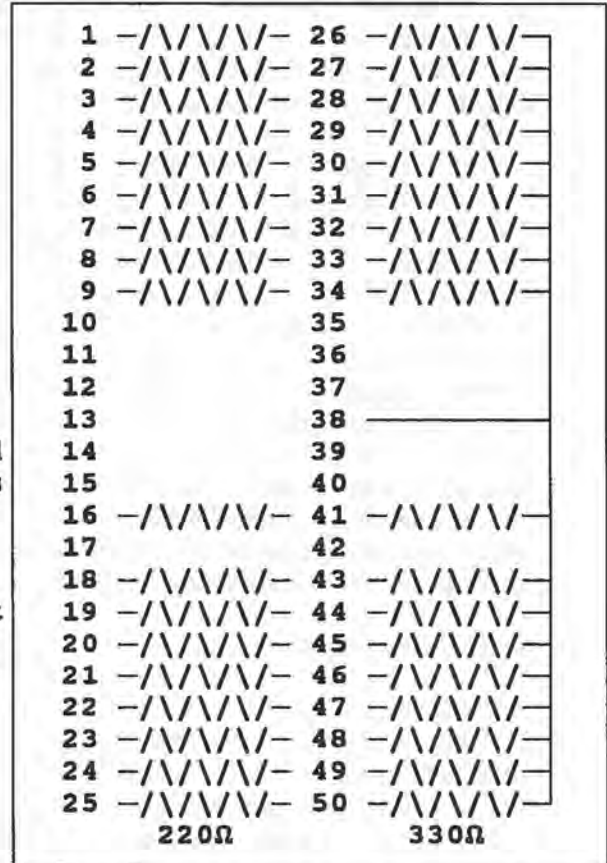

SCSI Terminator Schematic

(This space left unintentionally blank!)

# Controller Layouts

Adaptec

Data Technology

Perstor Systems

Promise Technology

Silicon Valley Computers

Storage Plus

UltraStor

Western Digital

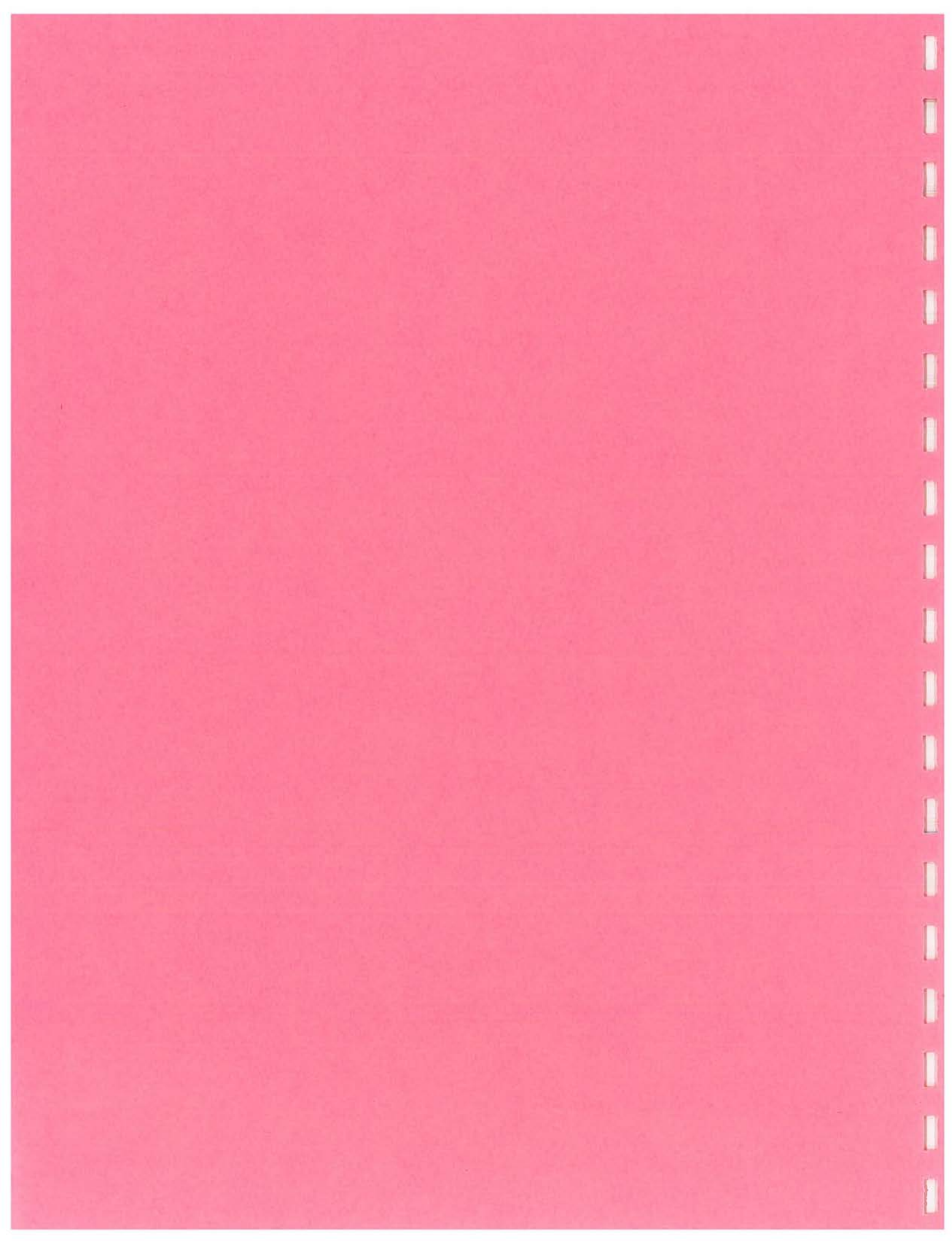



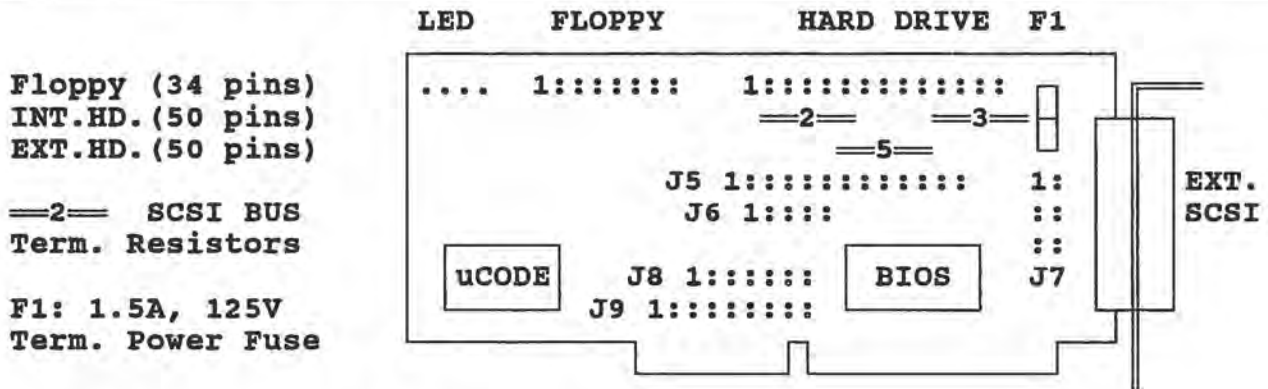

INTERFACE: ISA(AT)->SCSI-2  
 CONTROLS: 2 Floppy Drives (1542B only)(360KB, 720KB, 1.2MB, 1.44MB)  
 7 SCSI Devices

**J5: General Control**

J5-1: Synchronous Negotiation Enable: \*Disabled: (no Jumper)  
 Enabled: J5-1 Jumpered

J5-2: Diagnostics (Factory use ONLY): \*Disabled: (no jumper)

J5-3: SCSI Parity Bit: \*Enable Parity: (no jumper)  
 Disable Parity: J5-3 Jumpered

J5-4,5,6: SCSI Address: 0 1 2 3 4 5 6 7 (7 is Default)

4	x	-	x	-	x	-	x	-
5	x	x	-	-	x	x	-	-
6	x	x	x	x	-	-	-	-

(x = Jumpered)

J5-7,8: DMA Channel: 0 5 6 7 (5 is Default)

7	x	-	x	-
8	x	x	-	-

J5-9,10,11: Interrupt Chan.: 9 10 11 12 14 15 (11 is Default)

9	-	x	-	x	-	x
10	-	-	x	x	-	-
11	-	-	-	-	x	x

J5-12,13: DMA Transfer Speed: 5.0 5.7 6.7 8.0 (5.7 is Default)

12	-	x	-	x
13	-	-	x	x

J6: BIOS/Auto Sense Control: 1 x      1: BIOS Enable  
 2 -      2,3,4: Not Used  
 3 -      5: Auto Sense disable  
 4 -  
 5 -      (1 is Default)

**J7: Address Selection**

**J7-1: Floppy Secondary Address** (Default is not jumpered)

<b>J7-2,3,4: AT I/O Port Addr.:</b>	334	330	230	134	130	
	2	-	X	-	X	(Default
	3	-	-	X	X	is 330h)
	4	-	-	-	X	X

<b>J7-5,6: BIOS Wait State (ns):</b>	0	100	200	300		
	5	-	X	-	X	(Default
	6	-	-	X	X	is 0)

<b>J7-7,8: BIOS Address:</b>	DC000	CC000	D8000	C8000		
	7	-	X	-	X	(Default
	8	-	-	X	X	is DC000)

**J8: Floppy Disk Selection:**

1: Floppy Enable	(on Enabled)
2,3: DMA REQ. (2 or 3)	(2 DMA REQ.2)
4,5: DMA ACK. (2 or 3)	(4 DMA ACK.2)
6,7: INT.REQ. (6 or 10)	(6 INT.REQ.6)
8: Dual Speed Enable	(off Disabled)

(1542B only)

**J9: DMA/Interrupt:**

1,2,3,4: DMA REQ. (0,5,6,7)	(2 DMA REQ.5)
5,6,7,8: DMA ACK. (0,5,6,7)	(6 DMA ACK.5)
9,10,11,12,13,14: INT.REQ. (9,10,11,12,14,15)	(11 INT.REQ.11)

**Additional Info**

This Host Adapter may also be ordered with a high-density SCSI-2 external connector, as part no: 1540B100 or 1542B100.

SCSI bus terminators MUST be located at each end of the SCSI bus. If using internal SCSI peripherals only, the terminators on the H.A. must remain in place, and the device at the farthest point must also have it's terminators in place. All devices between must have their terminators removed. If using internal AND external peripherals, the devices at the end of the internal, and external cables should retain their terminators, and all those between, including the Host Adapter, should have theirs removed.

Adaptec has added support for drives larger than 1GB with their 3.20 BIOS and uCODE. When correctly set up, the host adapter will automatically select the correct translation for the drive. The translation for drives over 1GB increases the heads.

The 154x series is a Bus Mastering Host Adapter, and is well-suited for multi-tasking Operating Systems, such as UNIX and OS/2.

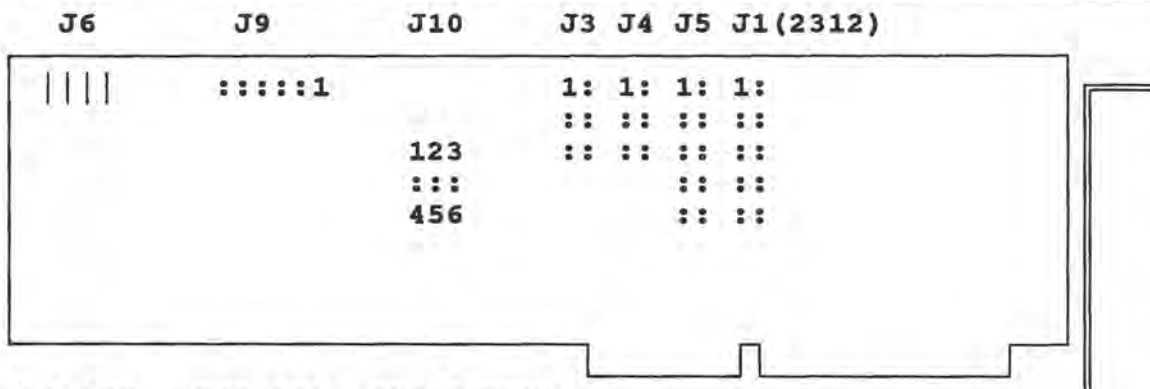

INTERFACE: ISA(AT)->ST412(MFM)  
 CONTROLS: 2 Floppy Drives (2312 only) (360KB, 720KB, 1.2MB, 144MB)  
 2 Hard Drives

J9: Option Jumpers: 1: Disable I/O Waite State  
 2: Track-1 ReCal., Step=35us.  
 3: (Not Used)  
 4: Serial Monitor Mode  
 5: Diagnostics Enable  
 6: (Reserved)

} Default Setting is NO JUMPERS installed.

J10: I/O Addresses: Hard Drive: \*Primary Address (1F0H): OFF  
 Secondary Address (170H): 4-5  
 Floppy Drive: \*Primary Address (3F0H): OFF  
 Secondary Address (370H): 1-2

J1: Floppy Drive (2312 only) (\* Default setting)  
 J5: HD Control  
 J4: HD0 Data  
 J3: HD1 Data  
 J6: HD LED

ADDITIONAL INFO

According to the Manufacturer, the ACB-2310/12 is 100% software and hardware compatible with the WD1003-WA2, but you are advised to do a Low Level Format to take advantage of the improved 1:1 Interleave that this controller offers. Note that there is no on-board BIOS, so no DOS Debug LLF option is available. Third party Formatting software is required, ie; Disk Manager(tm) or SpeedStor(tm).

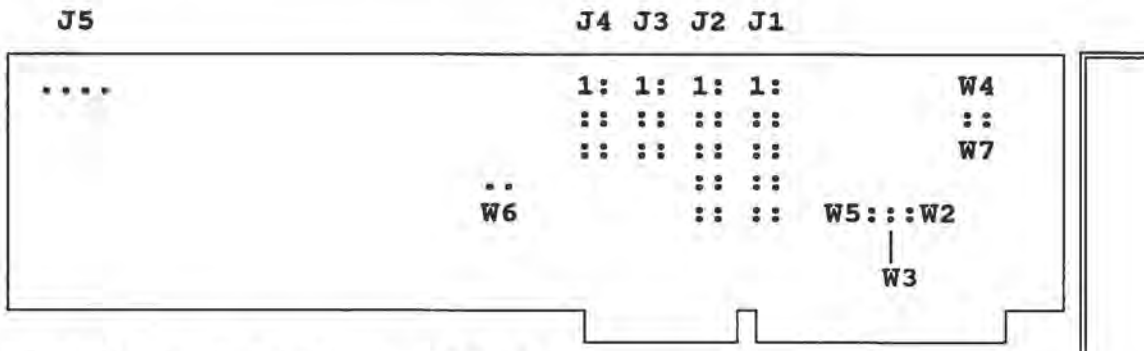

INTERFACE: ISA(AT) -> ST412 (RLL)

CONTROLS: 2 Floppy drives (360K, 720K, 1.2M, 1.44M)  
2 Hard Drives

W2, W3: Port Address Selection

\*1F0-1F7, 3F0-3F7 (Primary Address): (no Jumpers)

170-177, 370-377 (Secondary Address: W2, W3 Jumpered)

W4: Floppy Drive Transfer Rate

250KHz: W4 Jumpered

\*500KHz: (no Jumper)

J1: Floppy

J2: HD Control

J3: HD0 Data

J4: HD1 Data

J5: LED

W5: Drive Select Mode Type

\*Hardware Select Mode: W5 Jumpered

Firmware Select Mode: (no Jumper)

W6: Auto-Deselect Mode

\*Auto-Deselect Mode Enabled: W6 Jumpered

Auto-Deselect Mode Disabled: (no Jumper)

W7: Floppy Precompensation Selection

Precompensation at 125nSec: W7 Jumpered

\*Precompensation Scaled/Freq: (no Jumper)... (125nS@500KHz,

208nS@300KHz,

250nS@250KHz.)

\* Default Settings

#### ADDITIONAL INFO

The DTC7280 is a 1:1 interleave RLL controller. It will run at zero wait states up to a bus speed of 16MHz. The 7280 does not have an embedded Low Level Format routine, and requires The IBM AT Advanced Diagnostics, or similar 3rd party program for Low Level Formatting. The 7280 is OS/2 compatible.

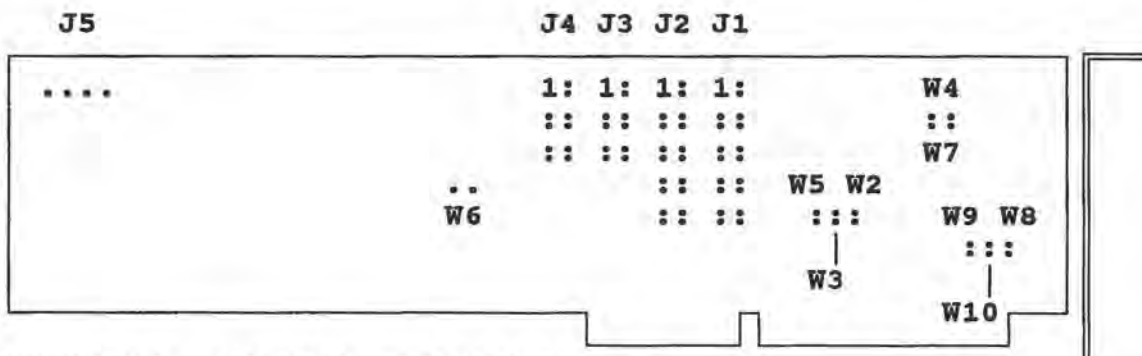

INTERFACE: ISA(AT) -> ST412 (RLL)

CONTROLS: 2 Floppy drives (360K, 720K, 1.2M, 1.44M)  
2 Hard Drives

W2, W3: Port Address Selection

\*1F0-1F7, 3F0-3F7 (Primary Address): (no Jumpers)

170-177, 370-377 (Secondary Address: W2, W3 Jumpered)

W4: Floppy Drive Transfer Rate

250KHz: W4 Jumpered

\*500KHz: (no Jumper)

J1: Floppy

J2: HD Control

J3: HD0 Data

J4: HD1 Data

J5: LED

W5: Drive Select Mode Type

\*Hardware Select Mode: W5 Jumpered

Firmware Select Mode: (no Jumper)

W6: Auto-Deselect Mode

\*Auto-Deselect Mode Enabled: W6 Jumpered

Auto-Deselect Mode Disabled: (no Jumper)

W7: Floppy Precompensation Selection

Precompensation at 125nSec: W7 Jumpered

\*Precompensation Scaled/Freq: (no Jumper)... (125nS@500KHz,  
208nS@300KHz,  
250nS@250KHz.)

\* Default Settings

W8: Reserved Jumper... MUST be installed for the controller to operate correctly.

W9: BIOS Address (16KB)

D800->DC00: W9 Jumpered

\*C800->CC00: (no jumper)

W10: BIOS Enable

\*Enable on-board BIOS: W10 Jumpered

Disable on-board BIOS: (no jumper)

## ADDITIONAL INFO

The DTC7280 is a 1:1 interleave RLL controller. It will run at zero wait states up to a bus speed of 16MHz. The 7280 does not have an embedded Low Level Format routine, and requires The IBM AT Advanced Diagnostics, or similar 3rd party program for Low Level Formatting. The 7280 is OS/2 compatible.

## SETUP NOTES

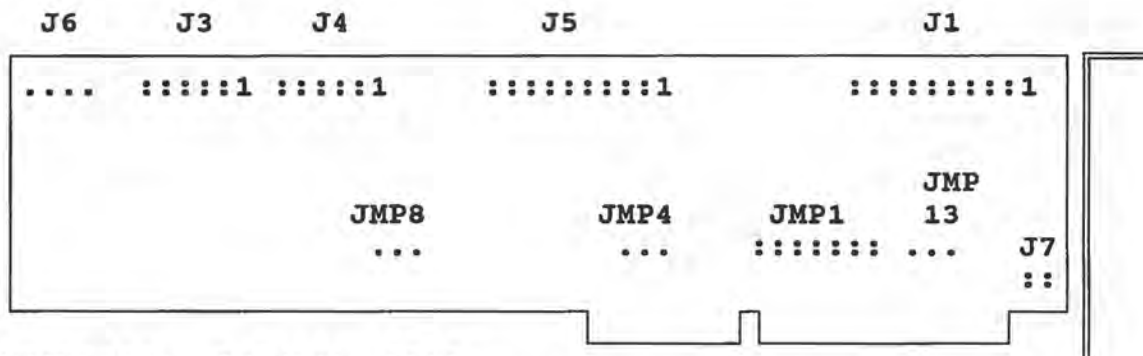

INTERFACE: ISA(AT)->ARLL

CONTROLS: 2 Floppy Drives (360KB, 720KB, 1.2MB, 1.44MB)  
 2 Hard Drives (MFM or RLL)

J1: Floppy (34 pin)

J5: HD Control (34 pin)

J3: HD1 Data (20 pin)

J6: HD LED (4 pin)

J4: HD0 Data (20 pin)

J7: Aux. HD Power

JMP1: BIOS ROM Address: \*BIOS Enable 1-2 Jumpered  
 \*C800:0 9-10 Jumpered  
 D800:0 9-10 Open (for use with  
 16-bit VGA cards)

JMP4: Floppy Address: \*Primary/Enable (3F0-3F7) 1-2 Jumpered  
 Secondary/Disable (370-377) 2-3 Jumpered

JMP13: Floppy Enable: \*Enable 1-2 Jumpered  
 Disable 2-3, AND JMP4 2-3 Jumpered

JMP8: HD Address: \*Primary (1F0-1F7) 1-2 Jumpered  
 Secondary (170-177) 2-3 Jumpered

Additional Information

J1: Floppy (34 pins)  
 J2: IDE (40 pins)

JP1: Serial Port 2  
 JP2: Port Configs.  
 JP3: Par. Port Mode  
 JP4: HD LED

CN1: Serial Port 1  
 CN2: Parallel Port

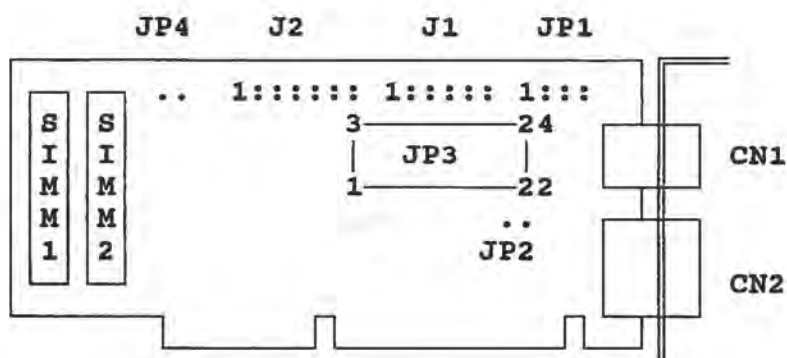

INTERFACE: ISA(AT)->IDE(AT)  
 CONTROLS: 2 Floppy Drives (360KB, 720KB, 1.2MB, 1.44MB)  
 2 IDE(AT) Drives

JP2: Parallel Port (CN2) Output Options: \*Output Only: Jumpered  
 Bi-Direct.: (no jumper)

[Note: OS/2 requires this port to be Bi-Directional. DOS requires only Output.]

JP3: Port Configurations:

Serial Port 1 (CN1): \*COM1 (3F8H, IRQ4): 1-2, 5-6  
 COM3 (3E8H, IRQ4): 2-3, 4-5  
 Disabled: 2-3, 5-6

Serial Port 2 (JP1): \*COM2 (2F8H, IRQ3): 7-8, 11-12  
 COM4 (2E8H, IRQ3): 8-9, 10-11  
 Disabled: 8-9, 11-12

Parallel Port (CN2): (3BCH, IRQ7): 13-14, 16-17, 20-21  
 \*(378H, IRQ7): 13-14, 17-18, 20-21  
 (278H, IRQ5): 14-15, 16-17, 19-20  
 Disabled: 14-15, 17-18

Floppy Disk (J1): \*Enable: 22-23 (\* Defaults)  
 Disable: 23-24

Additional Info

The DC-100 comes w/o Cache RAM, while the 100M has .5MB installed. Both will accept an additional 8MB in 2 SIMM sockets. You MUST add at least .5MB to the DC-100 before operation. (2-256KB SIMMS) This controller will not co-exist with another. It emulates the WD1003 for all Operating Systems. This IDE Host Adapter normally ships with a set of SuperIDE+ Utilities.

CAUTION!... As with ANY controller utilizing a cache, DO NOT turn the power off while the drive LED is lit. Data loss may occur!



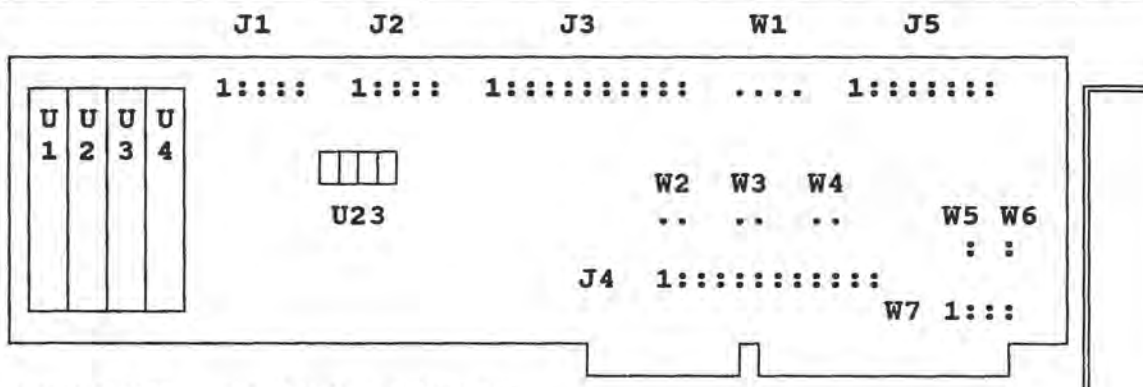

INTERFACE: ISA(AT)->IDE(AT)  
 CONTROLS : 2 Floppy Drives (360KB, 720KB, 1.2MB, 1.44MB)  
 2 IDE(AT) Hard Drives

J1,J2: Connectors for optional DC-2010 Expansion Memory Board.

J3: IDE Hard Drive connector

J4: IDE "Pass Through" connector. Connect to use Motherboard IDE controller w/2030 IDE support disabled. (W2 not jumpered)

J5: Floppy Disk connector

W1: Hard Drive activity LED.

W2: On-Board 2030 IDE controller enable: \*Enable: Jumpered  
 Disable: (not jumpered)

W3,W4,W5: Reserved

W6: Floppy Drive enable: \*Enable: Jumpered  
 Disable: (no jumper)

W7: BIOS Address:	C000	C2000	C4000	C6000	C8000	CA000	CC000	CE000
1-2:	ON	ON	ON	ON	ON	ON	ON	ON
3-4:	ON	ON	ON	ON	OFF	OFF	OFF	OFF
5-6:	ON	ON	OFF	OFF	ON	ON	OFF	OFF
7-8:	ON	OFF	ON	OFF	ON	OFF	ON	OFF
	D000	D2000	D4000	D6000	D8000	DA000	DC000	DE000
1-2:	OFF	OFF	OFF	OFF	OFF	OFF	OFF	OFF
3-4:	ON	ON	ON	ON	OFF	OFF	OFF	OFF
5-6:	ON	ON	OFF	OFF	ON	ON	OFF	OFF
7-8:	ON	OFF	ON	OFF	ON	OFF	ON	OFF

Additional Info

P1: HD LED (4 pins)  
 P2: Hard Drive (40 pins)  
 P3: Floppy Drive (34 pins)

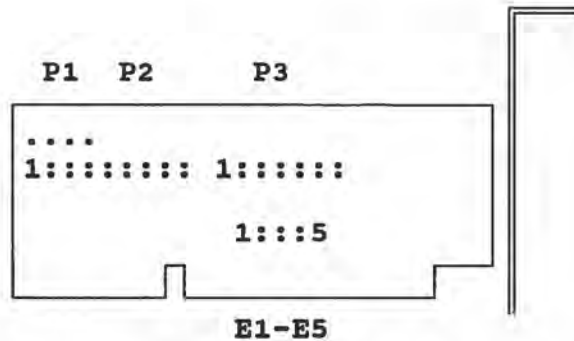

INTERFACE: ISA(AT)->IDE(AT)  
 CONTROLS: 2 Floppy Drives (360KB, 720KB, 1.2MB, 1.44MB)  
 2 IDE Hard Drives

E1,E4: Floppy Drive Enable: Both jumpers are hardwired on the back of the pcboard. To disable the floppy, the traces must be cut (voids the warranty). To re-enable floppy support, E1 & E4 must be jumpered.

E2: Floppy Precompensation  
 125ns: E2 Jumpered  
 \*105ns: (no Jumper) \*(Factory Default)

E3: Dual Speed Floppy Support  
 Dual Speed Floppy: E3 Jumpered  
 \*Single Speed Floppy: (no Jumper)

E5: Hard Drive Support: This jumper is hard-wired on the back of the pcboard. To disable the hard drive, the trace must be cut (this voids the Mfr. warranty). To re-enable hard drive support, E5 must be jumpered.

NOTES

(This area is currently blank for user notes.)

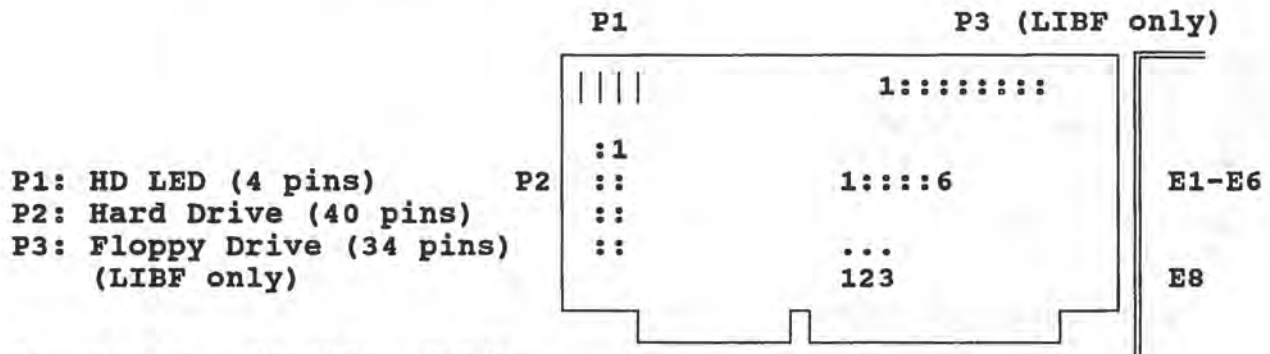

INTERFACE: ISA(AT)->IDE(AT)

CONTROLS: 2 Floppy Drives (LIBF only) (360KB, 720KB, 1.2MB, 1.44MB)  
2 IDE Hard Drives

E1: Floppy Drive Support Enable

\*Enable Floppy Support: (no Jumper)  
Disable Floppy Support: E1 Jumpered

E2, E3: FACTORY RESERVED... Default is no Jumper.

E4: I/O Port Address Selection

\*1F0-AF7 (Primary Address): (no Jumper)  
170-177 (Secondary Address): E4 Jumpered

E5: ROM BIOS Address (small)

\*C800h: (no Jumper)  
CA00h: E5 Jumpered

\*(Factory Default)

E6: ROM BIOS Address (large)

\*C8000h: (no Jumper)  
CA000h: E6 Jumpered

E7: BIOS Enable: This jumper is hard-wired on the back of the PC-Board to enable the on-board BIOS. (This jumper may or may not appear labeled on the PC Board.)

E8: FACTORY RESERVED... Default is 1-2 Jumpered.

NOTES

CN2: Int. SCSI (50 pin)  
 CN3: Ext. SCSI (50 pin)  
 CN4: Floppys (34 pin)  
 CN5: LED (4 pin)

==1== SCSI BUS  
 Term. Resistors

L: Term. Power Good LED  
 F1: 1.0A, 125V Term.  
 Power Fuse

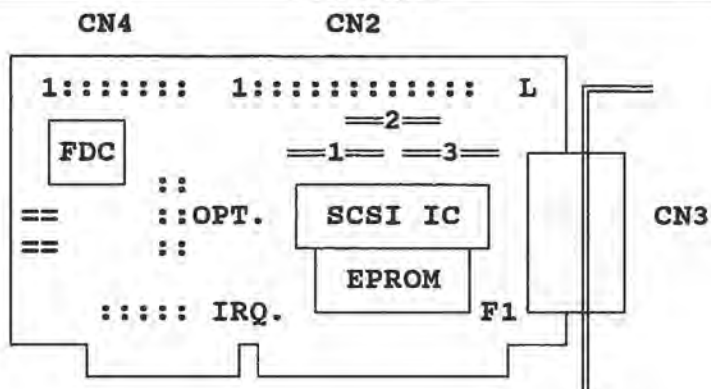

INTERFACE: ISA(AT)->SCSI-1  
 CONTROLS: 2 Floppy Drives (360KB, 720KB, 1.2MB, 1.44MB)  
 7 SCSI Devices

OPT.: Options Selection (Horizontal pairs):  
 OWS: AT Zero Wait State: Enable: OWS Jumpered  
 \*Disable: (no jumper)

CODE: (No mention of this jumper in the manual... The default setting is jumpered)

FLPY: Floppy Controller: \*Enable: FLPY Jumpered  
 Disable: (no jumper)

A,B,R: Memory Address:

	B	A	R
C800:0000-1FFF	X	X	X
CC00:0000-1FFF	-	X	X
D800:0000-1FFF	X	-	X
*DC00:0000-1FFF	-	-	X
Disable Memory	-	-	-

C,D,E,I: I/O Address:

	E	D	C	I	
300H	X	X	X	X	
*310H	-	X	X	X	
320H	X	-	X	X	(* Default Setting)
330H	-	-	X	X	
340H	X	X	-	X	
350H	-	X	-	X	
360H	-	X	X	X	
370H	-	-	-	X	
Disable	-	-	-	-	

IRQ: Interupt Selection: 3,4,5,10,11,12,14,15: Jumper the Interupt you desire to use. The default is 14. If no interupts are desired, don't jumper any. The manual recommends disabling IRQs for DOS. Otherwise, use #4(XT), or #14(AT).

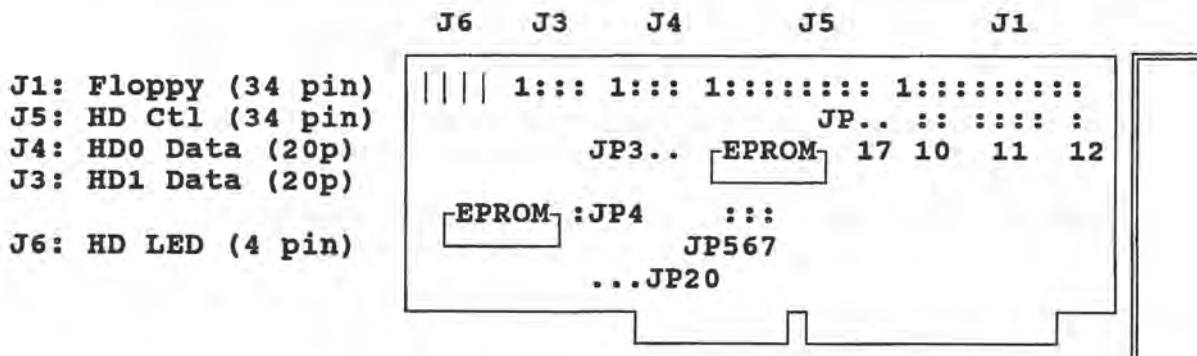

INTERFACE: ISA(AT)->ESDI

CONTROLS: 2 Floppy Drives (360KB, 720KB, 1.2MB, 1.44MB)  
2 ESDI Hard Drives

JP3: Factory use only: \*Jumpered

JP4: 1,2: Reserved (no pins)

3,4: Cache control: Disable (jumper 3-4)  
\*Enable (no jumper)

JP5: 1,2: Factory config'd: 32KB data buffer

JP6: 1,2: Factory config'd: 8K/32K data buffer

JP7: 1,2: Factory use only.

JP10: BIOS Address: Disable \*C800 CC00 D000 D400 D800 DC00 Disable

1-2:	--	--	--	--	ON	ON	ON	ON
3-4:	--	--	ON	ON	--	--	ON	ON
5-6:	--	ON	--	ON	--	ON	--	ON

JP11: Floppy Controller:

1,2: 3rd Floppy: ON: Single-twist cable, set drive as #4  
\*OFF: Double-twist cable, set drive as #2

3,4: 2nd Floppy: ON: PS/2 type floppy (3.5" only)  
\*OFF: AT type floppy (3.5" or 5.25")

5,6: 1st Floppy: ON: PS/2 type floppy (3.5" only)  
\*OFF: AT type floppy (3.5" or 5.25")

7,8: Floppy Address: ON: Secondary address (370-377)  
\*OFF: Primary address (3F0-3F7)

9,10: Speed: ON: Dual speeds (300, 360 RPM)  
\*OFF: Single speed (300 RPM)

11,12: Precomp: ON: Fixed at 125ns for all data rates.  
 \*OFF: Varies with data rate... 250KHz:250ns,  
 300KHz:208ns, 500KHz:125ns.

JP12: HD I/O address: ON: Secondary address (170-177)  
 \*OFF: Primary address (1F0-1F7)

JP17: Floppy Controller: \*ON: Enable Floppy support  
 OFF: Disable Floppy support

JP20: HD IRQ: 1-2: IRQ15  
 2-3: IRQ14

#### Setup Information

The 12F has a BIOS setup menu that is accessed using DEBUG at the controller's address, with an offset of 5. Thus, if you set the address to C800, you'd type DEBUG, then -g=c800:5 to get to the setup menu. The latest BIOS as of this writing is #9.00, and this guide reflects that.

#### Setup & Mapping Options

Drive Choices: 1: <1024 cyls, <63 sects, <528MB capacity  
 2: >1024 cyls, <63 sects, <528MB capacity  
 3: >1024 cyls, <63 sects, >528MB & </=1.2GB cap.  
 4: >1024 cyls, >63 sects, >528MB & </=1.2GB cap.  
 5: >1024 cyls, >63 sects, >1.2GB capacity

Operating Systems: DOS 3.3 on, and OS/2 1.1 on:

	-1-	-2-	-3-	-4-	-5-
1 spare/tk:	NO	NO	NO	NO	NO
sector map:	NO	63	NO	63	63
track map:	NO	NO	<1.2GB	<1.2GB	>1.2GB
1024 map:	NO	NO	NO	NO	NO

NOTE: As of the revision 9 BIOS, the rev.7 manual that I have is out of date, so UNIX setup info is up to you. (sorry)

#### Additional Info

When using a tape drive in the "3rd floppy" position, the tape software should normally work fine. However, if an actual floppy drive is used in that position, additional software will be needed to allow DOS to access the device. This software, EXFDRV.SYS, is available from UltraStor or your UltraStor Dealer.

Each drive should be Prep'd with the utility accessed through the DOS Debug command. Normally, the User will initiate a Low Level Format with the AUTOFORMAT field set to BRIEF. Choosing EXTENDED adds considerable time to the format, which is fully automatic.

	J6	J3	J4	J5	J1 (MM2)
J1: Floppy					
J3: HD1 Data	....	1::::	1::::	1:::::	1:::::
J4: HD0 Data					
J5: HD Control			W1 ::::		.. W3
J6: HD LED					.. W4
					.. W5
					W6 :

INTERFACE: ISA(AT) -> ST506/412 (MFM)

CONTROLS: 2 Floppy Drives (MM2 only; 360KB, 720KB, 1.2MB, 1.44MB)

W1: 1-2: Hard Drive Mode: OFF: Latched Mode  
\*ON: Non-Latched Mode

3-4: Error Correction Code (ECC), 4-byte: \*OFF: Enabled  
ON: (Reserved)

5-6: Caching: \*OFF: Caching Enabled  
ON: Caching Disabled

7-8: WD1003-WA2, WAH Compatibility for OFF: Incompatible  
Drives with 8 or more heads: ON: Compatible

W3: Hard Drive I/O Address: \*OFF: Primary address  
ON: Secondary address

W4: Floppy Drive I/O Address: \*OFF: Primary address  
ON: Secondary address

W5: Floppy Speed Support: OFF: Single Speed Drives only  
ON: Dual Speed Drives only

W6: Bracket Grounding Option: \*OFF: Bracket not grounded  
ON: Bracket grounded

#### Additional Info

W1:7-8 Addresses a disparity between the MMx series and the WA2/WAH series concerning heads #8-15. When replacing a WA2/WAH series with an MMx series on drives with over 8 physical heads, this jumper is required to maintain compatibility.

There is no Low Level Formatting routine contained on this card. A third-party LLF software program is required, ie; The IBM AT Advanced Diagnostics, KOLOD Research Utilities, or Western Digital AT Low Level Formatter (found on WD's BBS).

Do NOT mix single-speed and Dual-speed Floppy drives on the same controller.

	J6	J3	J4	J5	J1 (SR2)
J1: Floppy					
J5: HD Control	....	1:~::~	1:~::~	1:~::~	1:~::~
J4: HD0 Data					
J3: HD1 Data			:::W1		..W2
J6: HD LED					..W3
					..W4
					..W5 :W6

INTERFACE: ISA(AT)->ST412(RLL)

CONTROLS: 2 Floppy Drives (SR2 only) (360KB, 720KB, 1.2MB, 1.44MB)  
2 Hard Drives

W1: 1-2: Hard Disk Mode: Latched Mode: OFF  
Non-Latched Mode: ON

3-4: Error Correction Code: \*4-Byte ECC OFF  
7-Byte ECC: ON

5-6: Onboard Cache: Cache Enabled: OFF  
Cache Disabled: ON

W2: Onboard BIOS: BIOS Enabled: OFF  
BIOS Disabled: ON

W3: Hard Drive I/O Address: \*Primary Address: OFF  
Secondary Address: ON

W4: Floppy Drive I/O Address: \*Primary Address: OFF  
Secondary Address: ON

W5: Dual Speed Floppy Support: Single Speed Drives: OFF  
Dual Speed Drives: ON (note 1)

W6: Ground Connection: Bracket not connected to Board Ground: OFF  
Bracket connected to Board Ground: ON

(note 1) DO NOT mix single & dual speed drives in the same system.

(\* defaults)

#### ADDITIONAL INFO

Low Level Format can be done on boards that have their BIOS enabled by utilizing the DOS DEBUG command g=cc00:5.

It is recommended that a Format be accomplished when changing from a WD1003-XXX controller to the WD1006V type controller.



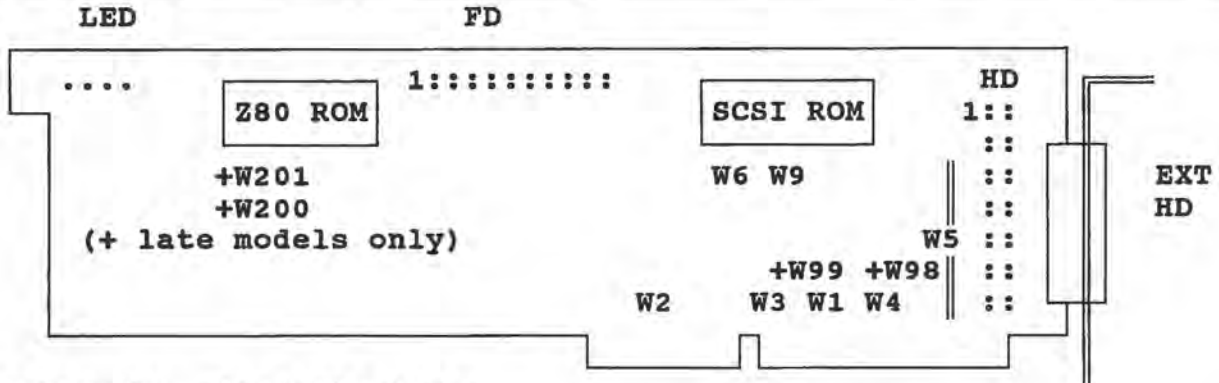

INTERFACE: ISA(AT)->SCSI  
 CONTROLS: 2 Floppy drives (360K, 720K, 1.2M, 1.44M)  
 7 SCSI devices (internal or external)

**W1: Interrupt Selection**  
 IRQ3: 1-2      IRQ7: 7-8  
 IRQ4: 3-4      IRQ9: 9-10  
 IRQ5: 5-6

**W2: Interrupt Selection**  
 \*IRQ15: 13-14      IRQ11: 19-20  
 IRQ14: 15-16      IRQ10: 21-22  
 IRQ12: 17-18

**W2: DRQ/DACK Selection**  
 DRQ7: 1-2      DACK7-: 7-8  
 \*DRQ6: 3-4      \*DACK6-: 9-10  
 DRQ5: 5-6      DACK5-: 11-12

**W3: I/O Address Selection**  
 \*SA3: 1-2  
 \*SA4: 3-4      (default is  
 SA5: 5-6      320h - use  
 \*SA6: 7-8      the chart)  
 \*SA7: 9-10

**W5: Terminator Power**  
 \*1-2 (always jumpered)

**+W98: BIOS Enable:**  
 \*ON: BIOS Enabled  
 OFF: BIOS Disabled (for 2nd  
 card in multi-card setup)

**+W99: ROM Size:**  
 1-2: Reserved  
 \*2-3: 8Kx8 ROMs

**+W100: Reserved...MUST be jumpered**

SA7	SA6	SA5	SA4	SA3	I/O Addr.
X	X	X	X	X	300H
X	X	X	X		308H
X	X	X		X	310H
X	X	X			318H
X	X		X	X	320H *
X	X		X		328H
X	X			X	330H
X	X				338H
X		X	X	X	340H
X		X	X		348H
X		X		X	350H
X		X			358H
X			X	X	360H
X			X		368H
X				X	370H
X					378H
	X	X	X	X	380H
	X	X	X		388H
	X	X		X	390H
	X	X			398H
	X		X	X	3A0H
	X		X		3A8H
	X			X	3B0H
	X				3B8H
		X	X	X	3C0H
		X	X		3C8H
		X		X	3D0H
		X			3D8H
			X	X	3E0H
			X		3E8H
				X	3F0H
					3F8H

## W4: BIOS Address:

\*SA13: 1-2

\*SA14: 3-4

SA15: 5-6

SA16: 7-8

(Default BIOS address is D800h. Use the chart to change the address.)

SA16	SA15	SA14	SA13	BIOS ADDR
X	X	X	X	C000h
X	X	X		C200h
X	X		X	C400h
X	X			C600h
X		X	X	C800h
X		X		CA00h
X			X	CC00h
X				CE00h
	X	X	X	D000h
	X	X		D200h
	X		X	D400h
	X			D600h
		X	X	D800h *
		X		DA00h
			X	DC00h
				DE00h

## +W200,201: Floppy Drive Type:

W200: 1st Floppy Drive:

1-2: PS/2 type floppy

\*2-3: AT/ANSI type floppy

W201: 2nd Floppy Drive:

1-2: PS/2 type floppy

\*2-3: AT/ANSI type floppy

W7: 1-2: Floppy Speed Support: ON: Dual Speed (300/360) support  
\*OFF: Single Speed only (300 rpm)

W8: 1-2: Floppy Write Precomp: ON: 187ns write precomp.  
\*OFF: 125ns write precomp.

## W6,W9: Floppy Controller:

\*W6: 1-2

\*W9: 1-2

W6	W9	FUNCTION ENABLED
X	X	-Floppy Support Disabled
	X	-Floppy Support Enabled w/Hard-Card Only.
		-Floppy Support Enabled w/no Hard-Card or Combo installed.

Normal settings for Floppy Support will have the jumpers at W6 & W9 removed.

## Additional Info

Due to Engineering Changes in the 7000, additional jumpers were added (W98,99,100,200,201) increasing the board's flexibility. These are marked with a (+). Newer models also added an LED and fuse for term. power.

Software for the 7000 comes from Columbia Data Products, called SST. The OEM version of the board is the 7000-ASC, and the consumer version, with the SST software, is called 7000-FASST, or 7000-FASST2. The Hardware design was sold to Future Domain Corp. in 1991.

# Controller Specs

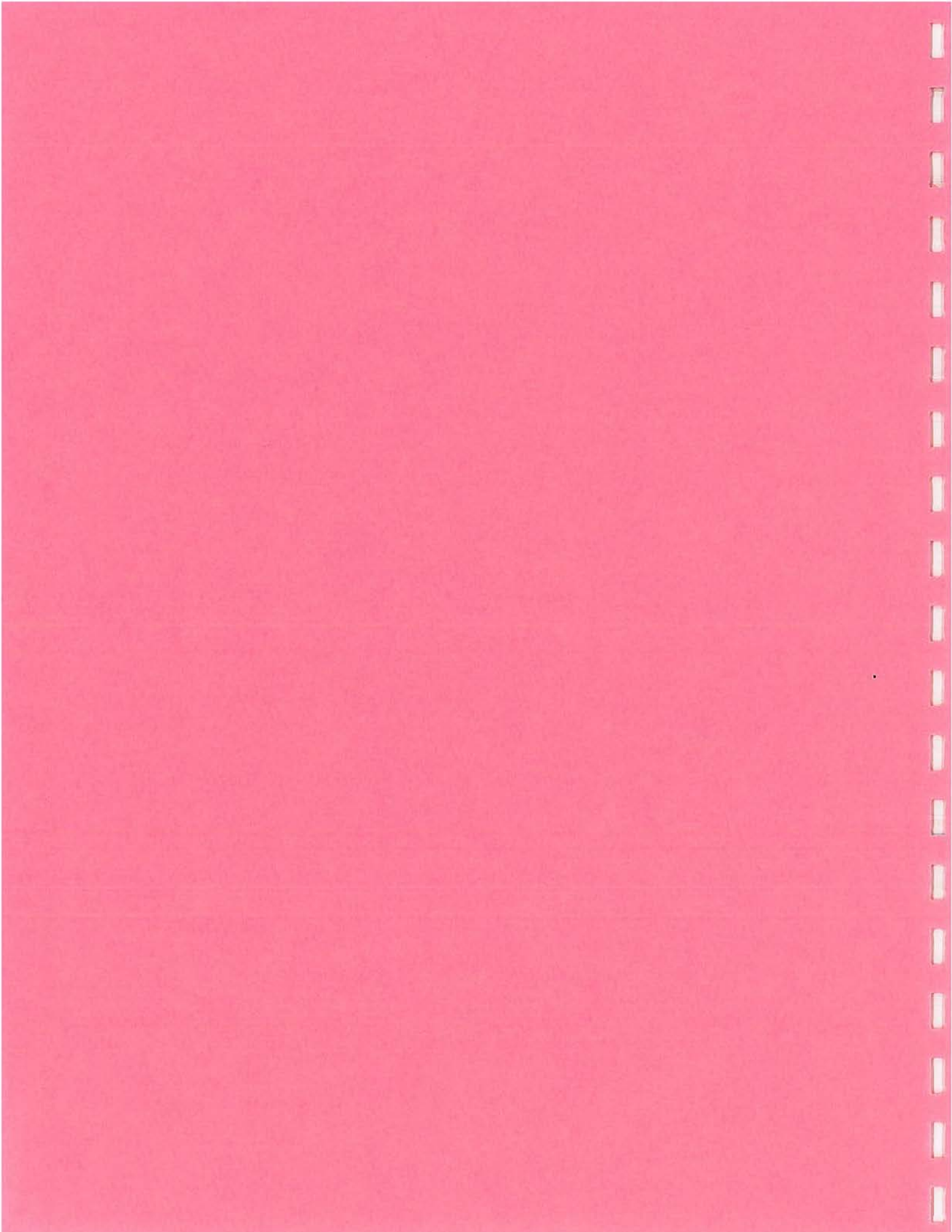

## DRIVE CONTROLLER DIRECTORY

THEREF(tm) Version 4.30

05/01/93

MANUFACTURER	MODEL NUMBER	INTERFACES	BUS SUPPORT	INTER LEAVE	--MAX-- HDS FDS	---MAX--- CYLS HDS	ECC LGN.	B C	--SIZE-- LGN. HGT.	-CONTROLLER FLOPPY	IC-- HARD	ADDITIONAL COMMENTS	PAGE 1
A.I.R.	SCSI2V	ISA(LB)-SCSI-2	ISA(VL)		7HD 2FD			B C	3/4 XT		NCR	(BUS MASTER), ASPI COMPLIANT	
ACCULOGIC	EIASPPORT	EISA-SCSI-2	EISA		7HD 2FD			B C				(BUS MASTER), 2.88MB FLOPPY	
ACCULOGIC	ISAPPORT	ISA-SCSI-2	AT		7HD 2FD			B				(PIO), 2.88MB FLOPPY	
ADAPTEC	ACB-2010	ISA-ST412(MFM)	PC,XT		2HD							XT	
ADAPTEC	ACB-2070	ISA-ST412(RLL)	PC,XT		2HD							XT	
ADAPTEC	ACB-2071	ISA-ST412(RLL)	XT		1HD							XT	
ADAPTEC	ACB-2072	ISA-ST412(RLL)	PC,XT	2:1	2HD	2048 16	32	B	1/2 XT				
ADAPTEC	ACB-2310	ISA-ST412(MFM)	AT	1:1	2HD								
ADAPTEC	ACB-2312	ISA-ST412(MFM)	AT	3:1	2HD 2FD								
ADAPTEC	ACB-2320(A-D)	ISA-ESDI	AT	1:1	2HD	4096 16	48	B	3/4 XT			[A,B,C]:16KB, [D]:64KB CACHE	
ADAPTEC	ACB-2322(B-D)	ISA-ESDI	AT	1:1	2HD 2FD	4096 16	48	B	FULL XT			64KB CACHE	
ADAPTEC	ACB-2370	ISA-ST412(RLL)	AT	1:1	2HD	4096 16	48	B	3/4 XT				
ADAPTEC	ACB-2372C	ISA-ST412(RLL)	AT	1:1	2HD 2FD	4096 16	48	B	FULL XT				
ADAPTEC	ACB-2610	MCA-ST412(MFM)	MCA	1:1	2HD	4096 16	48		FULL MC			BUFFER OPTION, CACHE	
ADAPTEC	ACB-2670	MCA-ST412(RLL)	MCA	1:1	2HD	4096 16	48	*	FULL MC			BUFFER OPTION,CACHE,*BIOS OPT.	
ADAPTEC	ACB-26M20	MCA-ESDI	MCA	1:1	2HD	4096 16	48	B	FULL MC			CACHE, BUFFER	
ADAPTEC	ACB-3530	SCSI-QIC36	NONE									(TAPE) DOES NOT PLUG INTO BUS	
ADAPTEC	ACB-3540	SCSI-QIC120	NONE									(TAPE) DOES NOT PLUG INTO BUS	
ADAPTEC	ACB-4000A	SCSI-ST412(MFM)	NONE	1:1	2HD	16	32	B				DOES NOT PLUG INTO BUS	
ADAPTEC	ACB-4010	SCSI-ST412(MFM)	NONE	1:1	2HD	16	32					MACINTOSH SCSI	
ADAPTEC	ACB-4070	SCSI-ST412(RLL)	NONE	1:1	2HD	16						DOES NOT PLUG INTO ISA BUS	
ADAPTEC	ACB-4520	SCSI-ESDI	NONE	1:1	2HD							DOES NOT PLUG INTO ISA BUS	
ADAPTEC	ACB-4525Z	SCSI-ESDI	NONE	1:1	2HD	16	32	B				DOES NOT PLUG INTO ISA BUS	
ADAPTEC	ACB-5500	SCSI-ST412(MFM)	NONE	1:1	4HD	16	32	B				DOES NOT PLUG INTO ISA BUS	
ADAPTEC	ACB-5580A	SCSI-SMD	NONE	1:1	4HD	16	32	B				DOES NOT PLUG INTO ISA BUS	
ADAPTEC	ACB-5580D	SCSI(DIF.)-SMD	NONE	1:1	4HD	16	32	B				DOES NOT PLUG INTO ISA BUS	
ADAPTEC	ACB-5585A	SCSI-ESMD	NONE	1:1	4HD	16	32	B				DOES NOT PLUG INTO ISA BUS	
ADAPTEC	ACB-5585D	SCSI(DIF.)-ESMD	NONE	1:1	4HD	16						DOES NOT PLUG INTO ISA BUS	
ADAPTEC	AHA-1020	ISA-SCSI	PC,XT,AT		7HD			B C	1/2 XT			HOST ADAPTER	

MANUFACTURER	MODEL NUMBER	INTERFACES	BUS SUPPORT	INTER LEAVE	--MAX-- HDs FDS	---MAX--- CYLS HDS	ECC LGN.	B C	--SIZE-- LGN. HGT.	-CONTROLLER FLOPPY	IC-- HARD	ADDITIONAL COMMENTS	PAGE 2
ADAPTEC	AHA-1520	ISA-SCSI	AT		7HD			B	1/2 XT		AIC 6260	(PIO) PROGRAMMED I/O	
ADAPTEC	AHA-1522	ISA-SCSI	AT		7HD 2FD			B	1/2 XT	NS DP8473	AIC 6260	(PIO) PROGRAMMED I/O	
ADAPTEC	AHA-1540A	ISA-SCSI	AT		7HD			B C	FULL XT		AIC 6250,60	(BUS MASTER) 1ST PARTY DMA	
ADAPTEC	AHA-1540B	ISA-SCSI	AT		7HD			B C	3/4 XT		AIC 6250	(BUS MASTER) 1ST PARTY DMA	
ADAPTEC	AHA-1540C	ISA-SCSI	AT		7HD			B C	3/4 XT			(BUS MASTER) 1ST PARTY DMA	
ADAPTEC	AHA-1542A	ISA-SCSI	AT		7HD 2FD			B C	FULL XT		AIC 6250,60	(BUS MASTER) 1ST PARTY DMA	
ADAPTEC	AHA-1542B	ISA-SCSI	AT		7HD 2FD			B C	3/4 XT	NS DP8473	AIC 6250	(BUS MASTER) 1ST PARTY DMA	
ADAPTEC	AHA-1542C	ISA-SCSI	AT		7HD 2FD			B C	3/4 XT			(BUS MASTER) 1ST PARTY DMA	
ADAPTEC	AHA-1640	MCA-SCSI	MCA		7HD				FULL MC		AIC 6250	(BUS MASTER) 1ST PARTY DMA	
ADAPTEC	AHA-1740	EISA-SCSI-2F	EISA		7HD			B C	FULL XT			(BUS MASTER) 1ST PARTY DMA	
ADAPTEC	AHA-1744	EISA-SCSI-2F(D)	EISA		7HD			B C	FULL XT			(BUS MASTER),DIFFERENTIAL SCSI	
ADVANCED INFO.	MCA	MCA-SCSI	MCA								NCR 53C94	(DMA)	
ADVANCED INFO.	PC/AT	ISA-SCSI	XT,AT								NCR 53C90A	(PIO) PROGRAMMED I/O	
ADVANCED STOR.	ASC-86	ISA-SCSI	AT								NCR 53C94	(DMA), 16 BYTE BUFFER	
ADVANCED STOR.	ASC-88	ISA-SCSI	XT,AT								NCR 53C80	(DMA)	
ADVANCED STOR.	ASC-PS2	MCA-SCSI	MCA								NCR 53C90A	(DMA), 16 BYTE BUFFER	
ALPHA RESEARCH	S420S	ISA-SCSI-2	AT		7HD 2FD			B C					
ALPHA RESEARCH	S425I	ISA-IDE(AT)	AT	1:1	4HD 2FD			B C				.5-16MB CACHE,12MHZ BUS,>528MB	
ALPHA RESEARCH	S455I	EISA-IDE(AT)	EISA	1:1	4HD 2FD			B C				.5-16MB CACHE, >528MB SUPPORT	
ALPHA RESEARCH	S455S	EISA-SCSI-2F	EISA		7HD 2FD			B C				.5-16MB CACHE, >528MB SUPPORT	
ALPHA RESEARCH	S465I	OPTI LB-IDE(AT)	LOCALBUS	1:1	4HD 2FD			B				.5-16MB CACHE, >528MB SUPPORT	
ALWAYS TECHNOLOGY	AL-1000	LPT-SCSI	PRINTER									(PIO),ATTACHES TO PRINTER PORT	
ALWAYS TECHNOLOGY	AL-4000	EISA-SCSI-2F	EISA		7HD			B C	FULL		WD 33C93A	0-32MB CACHE	
ALWAYS TECHNOLOGY	AL-6200	EISA-SCSI-2	EISA		7HD			B				(BUS MASTER), 0-32MB CACHE	
ALWAYS TECHNOLOGY	IN-2000	ISA-SCSI	AT		7HD 2FD			B C	1/2 XT		WD 33C93A	(PIO) PROGRAMMED I/O	
AMI	SCSI H.A.	EISA-SCSI-2	EISA		7HD				FULL			0-16MB CACHE	
AMS	1100S	ISA-ST412(MFM)	AT		2HD 2FD								
AMS	1100SM	ISA-ST412(MFM)	AT	1:1	2HD 2FD								
AMS	1100SM4	ISA-ST412(MFM)	AT	1:1	2HD 4FD								
AMS	1100SR4	ISA-ST412(RLL)	AT	1:1	2HD 4FD							SHORT CARD	
ARCO ELECTRONICS	AC-1070	MCA-IDE(AT)	MCA					B C	2/3 MC				

MANUFACTURER	MODEL NUMBER	INTERFACES	BUS SUPPORT	INTER LEAVE	--MAX-- HDs FDs	---MAX--- CYLs HDS	ECC LGN.	B C	--SIZE-- LGN. HGT.	-CONTROLLER IC-- FLOPPY HARD	ADDITIONAL COMMENTS
ATD	220-000	ISA-ST412(MFM)	AT	1:1	2HD 2FD	2048 16	32	B	1/2 XT		
ATD	220-001	ISA-ST412(MFM)	AT	1:1	2HD	2048 16	32	B	1/2 XT		
ATD	221-000	ISA-ST412(RLL)	AT	1:1	2HD 2FD	2048 16		B			
ATD	221-001	ISA-ST412(RLL)	AT	1:1	2HD	2048 16		B			
ATD	222-000	ISA-ESDI	AT	1:1	2HD 2FD	2048 16		B			
ATD	222-001	ISA-ESDI	AT	1:1	2HD			B			24Mbps
ATTO TECHNOLOGY	S.A. EISA	EISA-SCSI-2	EISA		7HD			B			(BUS MASTER), ASPI & CAM
ATTO TECHNOLOGY	S.A. ISA	ISA-SCSI-2	AT		7HD			B	HALF XT	EMULEX	(DMA SLAVE or PIO), ASPI/CAM
ATTO TECHNOLOGY	S.A. MCA	MCA-SCSI-2	MCA		7HD			B	FULL MC	EMULEX	(DMA SLAVE or PIO), ASPI/CAM
ATTO TECHNOLOGY	SiliconCache	SCSI-SCSI	SCSI								SCSI BUS CACHE, 32-512MB
ATTO TECHNOLOGY	S.EXPR. I	NuBUS-SCSI-2	NuBUS						FULL NB		SiliconExpress, BUS MASTER
ATTO TECHNOLOGY	S.EXPR. II	NuBUS-SCSI-2F	NuBUS						FULL NB		SiliconExpress, BUS MASTER
ATTO TECHNOLOGY	S.EXPR. IIID	NuBUS-SCSI-2D	NuBUS						FULL NB		SiliconExpress, BUS MASTER
ATTO TECHNOLOGY	S.EXPR. IV	NuBUS-SCSI-2FW	NuBUS						FULL NB		SiliconExpress, BUS MASTER
AXES TECHNOLOGY	SOFI-16	ISA-SCSI	AT		7HD						1-4MB CACHE
BOCA DESIGN	SB-352M	ISA-SCSI	PC,XT,AT		7HD			B	1/2 XT		
BOCA DESIGN	SC-352FM	ISA-SCSI	PC,XT,AT		7HD 4FD			B	2/3 XT		
BUSLOGIC	BT-445S	ISA(VL)-SCSI-2F	ISA(VL)		7HD 2FD			B	3/4 AT		VESA BUS MASTER,ASPI COMPLIANT
BUSLOGIC	BT-542B	ISA-SCSI-2	AT		7HD 2FD			B C	1/2 AT	NS DP8473 NCR 53C94	(BUS MASTER)
BUSLOGIC	BT-542D	ISA-SCSI-2FD	AT		7HD 2FD			B C	FULL AT	NS DP8473 NCR 53C94	BUS MASTER, DIFFERENTIAL SCSI
BUSLOGIC	BT-542S	ISA-SCSI-2F	AT		7HD 2FD			B C	FULL AT	NS DP8473 NCR 53C94	BUS MASTER, 2.88MB FLOPPY
BUSLOGIC	BT-640A	MCA-SCSI-2	MCA		7HD			B C	FULL MC	NCR 53C94	BUS MASTER,PASSIVE TERMINATION
BUSLOGIC	BT-646D	MCA-SCSI-2FD	MCA		7HD			B C	FULL MC		BUS MASTER, DIFFERENTIAL SCSI
BUSLOGIC	BT-646S	MCA-SCSI-2F	MCA		7HD			B C	FULL MC		BUS MASTER, ACTIVE TERMINATION
BUSLOGIC	BT-742A	EISA-SCSI-2	EISA		7HD 2FD			B C	1/2 AT	NS DP8473 NCR 53C94	BUS MASTER,PASSIVE TERMINATION
BUSLOGIC	BT-747D	EISA-SCSI-2FD	EISA		7HD 2FD			B C	2/3 AT		BUS MASTER,DIF.SCSI,2.88MB FPY
BUSLOGIC	BT-747S	EISA-SCS--2F	EISA		7HD 2FD			B C	2/3 AT		BUS MASTER,ACT.TERM,2.88MB FPY
C & C TECHNOLOGY	CC-THDC	ISA-SCSI	AT							NCR 53C700	(DMA), DIFFERENTIAL SCSI
C.S.C.	FASTCACHE 32	ISA-SCSI	AT		7HD 4FD			B C	FULL AT	NS DP8473 NCR 53C400	256K-8MB CACHE (STD. SIMMs)
C.S.C.	FASTCACHE 64	ISA-SCSI	AT		7HD 4FD			B	FULL XT		64MB MAX. CACHE, 2.88MB FLOPPY
C.S.C.	FLASHCACHE 64	ISA-IDE(AT)	AT		2HD 4FD			B	FULL XT		64MB MAX. CACHE

MANUFACTURER	MODEL NUMBER	INTERFACES	BUS SUPPORT	INTER LEAVE	--MAX-- HDS FDS	---MAX--- CYLS HDS	ECC LGN.	B C	--SIZE-- LGN. HGT.	-CONTROLLER FLOPPY	IC-- HARD	ADDITIONAL COMMENTS
CHICONY	C101B	ISA-IDE(AT)	AT		2HD 2FD							1-SERIAL, 1-PARALLEL PORT
CIPRICO	RIMFIRE RF5500	ISA-SCSI-2	AT		7HD			B C	FULL		WD 33C93	
CIPRICO	RIMFIRE RF5600	EISA-SCSI-2	EISA		7HD			B C	FULL			
CIPRICO	RIMFIRE RF5700	MCA-SCSI-2	MCA		7HD			B C	FULL MC			
COGENT DATA	DISKMASTER	ISA-ST412/ESDI	AT	1:1	4HD							DISK MIRRORING
COMMAX TECH.	EXCELL-HDC6V	ISA-ST412(MFM)	AT	1:1	2HD 2FD				3/4 XT			
COMPUADD	HARDCACHE ESDI	ISA-ESDI	AT	1:1	2HD 2FD			B	FULL XT			256K-4MB CACHE
CONTROL CONCEPTS	SCSI/IDE/FLOPP	ISA-SCSI & IDE	AT		9HD 4FD			B C	2/3 XT			
CORE INTL.	CNT-IMC	MCA-ESDI	MCA	1:1	2HD				FULL MC			256K-4MB CACHE
CORE INTL.	CNT-MCK	MCA-ST412M/ESDI	MCA	1:1	2HD				FULL MC			
COREL SYSTEMS	LS2000	ISA-SCSI	XT,AT		7HD			*	1/2 XT		NCR 53C400	(PIO),*OPT.BIOS,2x128B BUFFER
COREL SYSTEMS	LS2000-MC	MCA-SCSI-2	MCA		7HD				FULL MC			
COREL SYSTEMS	LS3000	ISA-SCSI	AT		7HD 2FD			B C	2/3 XT			(BUS MASTER)
D.P.T.	CM401x	PROPRIETARY										CACHING MODULE W/512KB
D.P.T.	DM401x	PROPRIETARY										DISK MIRRORING MODULE
D.P.T.	MM3011/2	PROPRIETARY	NONE									PLUG-IN 2MB MEMORY MODULE
D.P.T.	MM3011/4	PROPRIETARY	NONE									PLUG-IN 4MB MEMORY MODULE
D.P.T.	MM401x/2	PROPRIETARY										2MB MEMORY MODULE
D.P.T.	MM401x/4	PROPRIETARY										4MB MEMORY MODULE
D.P.T.	MX3011/4	PROPRIETARY	NONE									4MB MEM.CARD, TAKES 2 MEM.MODS
D.P.T.	MX401x/4	PROPRIETARY										4MB EXPANSION BOARD
D.P.T.	PM2001/90	ISA-SCSI	AT		7HD			B	3/4 AT		NCR50C94	(PIO), "SmartConnex"
D.P.T.	PM2001/95	ISA-SCSI	AT		7HD 2FD			B	3/4 AT	WD37C65B	NCR50C94	(PIO), "SmartConnex"
D.P.T.	PM2012/90	EISA-SCSI	EISA		7HD			B	FULL AT		NCR50C94	(PIO), "SmartConnex"
D.P.T.	PM2012/95	EISA-SCSI	EISA		7HD 2FD			B	FULL AT	WD37C65B	NCR50C94	(PIO), "SmartConnex"
D.P.T.	PM3011/50	ISA-ST412(MFM)	AT	1:1	2HD			B	FULL AT			.5-4.5MB CACHE, OPT.MEM.MODs
D.P.T.	PM3011/55	ISA-ST412(MFM)	AT	1:1	2HD 2FD			B	FULL AT	WD37C65B		.5-4.4MB CACHE, OPT.MEM.MODs
D.P.T.	PM3011/60	ISA-ST412(RLL)	AT	1:1	2HD			B	FULL AT			.5-4.5MB CACHE, OPT.MEM.MODs
D.P.T.	PM3011/65	ISA-ST412(RLL)	AT	1:1	2HD 2FD			B	FULL AT	WD37C65B		.5-4.5MB CACHE, OPT.MEM.MODs
D.P.T.	PM3011/70	ISA-ESDI	AT	1:1	4HD			B	FULL AT			.5-4.5MB CACHE, OPT.MEM.MODs
D.P.T.	PM3011/75	ISA-ESDI	AT	1:1	4HD 2FD			B	FULL AT	WD37C65B		.5-4.5MB CACHE, OPT.MEM.MODs



MANUFACTURER	MODEL NUMBER	INTERFACES	BUS SUPPORT	INTER LEAVE	--MAX-- HDs	FDs	---MAX--- CYLS	HDS	ECC LGN.	B	C	--SIZE-- LGN.	HGT.	-CONTROLLER FLOPPY	IC-- HARD	ADDITIONAL COMMENTS
D.P.T.	PX3011/05	ISA-FLOPPY				2FD								WD37C65B		OLDER 50-70 ADD-ON
D.P.T.	PX3011/059	ISA-FLOPPY/SCSI				7HD 2FD								WD37C65B		OLDER 50-70 ADD-ON
D.P.T.	PX3011/09	ISA-SCSI				7HD										OLDER 50-70 ADD-ON
DATA TECHNOLOGY	DTC-2190	EISA-IDE(AT)	EISA	1:1	4HD					B	C	2/3	XT			
DATA TECHNOLOGY	DTC-2290	EISA-IDE(AT)	EISA	1:1	4HD	4FD				B	C	2/3	XT	N82077AA-1		
DATA TECHNOLOGY	DTC-3150	ISA-SCSI	XT,AT		7HD					B	C	1/2	XT			(PIO) PROGRAMMED I/O
DATA TECHNOLOGY	DTC-3180	ISA-SCSI	AT		7HD					B	C	1/2	XT			(PIO) PROGRAMMED I/O
DATA TECHNOLOGY	DTC-3190HD	EISA-SCSI	EISA		7HD					B	C	FULL	AT			(BUS MASTER), .5-4MB CACHE
DATA TECHNOLOGY	DTC-3250	ISA-SCSI	XT,AT		7HD	3FD				B	C	1/2	XT			(PIO) PROGRAMMED I/O
DATA TECHNOLOGY	DTC-3280	ISA-SCSI	AT		7HD	4FD				B	C	1/2	XT			(PIO) PROGRAMMED I/O
DATA TECHNOLOGY	DTC-3290HD	EISA-SCSI	EISA		7HD	4FD				B	C	FULL	AT	NS7483		(BUS MASTER), .5-4MB CACHE
DATA TECHNOLOGY	DTC-3292	EISA-SCSI-2	EISA		7HD	2FD				B		FULL	AT			(BUS MASTER), 64KB CACHE
DATA TECHNOLOGY	DTC-5110	ISA-FLOPPY	XT,AT			3FD						1/2	XT			FLOPPY DRIVES ONLY
DATA TECHNOLOGY	DTC-5150X	ISA-ST412(MFM)	XT	2:1	2HD		2048	16		B		1/2	XT			
DATA TECHNOLOGY	DTC-5150XL	ISA-ST412(MFM)	XT	2:1	2HD		2048	16		B	C	1/2	XT			
DATA TECHNOLOGY	DTC-5160X	ISA-ST412(RLL)	XT	2:1	2HD		2048	16		B		1/2	XT			
DATA TECHNOLOGY	DTC-5160XL	ISA-ST412(RLL)	XT,AT	2:1	2HD		2048	16		B	C	1/2	XT			
DATA TECHNOLOGY	DTC-5180i	ISA-ST412(MFM)	AT		2HD		2048	16	32	B	C	1/2	XT			POWER CONNECTOR ON BOARD
DATA TECHNOLOGY	DTC-5187i	ISA-ST412(RLL)	AT		2HD		2048	16		B	C	1/2	XT			POWER CONNECTOR ON BOARD
DATA TECHNOLOGY	DTC-5280i	ISA-ST412(MFM)	AT		2HD	2FD	2048	16	32			FULL	XT			
DATA TECHNOLOGY	DTC-5287i	ISA-ST412(RLL)	AT		2HD	2FD	2048	16		B		FULL	XT			
DATA TECHNOLOGY	DTC-6180	ISA-ESDI	AT	1:1	2HD		4096	16		B		FULL	XT			
DATA TECHNOLOGY	DTC-6180-15C	ISA-ESDI	AT	1:1	2HD		*	16	64	B		FULL				.5-4MB CACHE, *>1024 CYLINDERS
DATA TECHNOLOGY	DTC-6180-15T	ISA-ESDI	AT	1:1	2HD		*	16	64	B		3/4	XT			TRACK BUFFER, *>1024 CYLINDERS
DATA TECHNOLOGY	DTC-6195-24	EISA-ESDI	EISA	1:1	2HD		4096	*		B		FULL	AT			.5-2MB CACHE, *>1024 CYLINDERS
DATA TECHNOLOGY	DTC-6280	ISA-ESDI	AT	1:1	2HD	2FD	4096	16		B		FULL	XT			
DATA TECHNOLOGY	DTC-6280-15C	ISA-ESDI	AT	1:1	2HD	4FD	*	16	64	B		FULL				.5-4MB CACHE, *>1024 CYLINDERS
DATA TECHNOLOGY	DTC-6280-15T	ISA-ESDI	AT	1:1	2HD	4FD	*	16	64	B		3/4				TRACK BUFFER, *>1024 CYLINDERS
DATA TECHNOLOGY	DTC-6280SE-15C	EISA-ESDI	EISA	1:1	4HD		4096	*		B		FULL	AT	DTC403/4		.5-2MB CACHE, *>1024 CYLINDERS
DATA TECHNOLOGY	DTC-6295-24	EISA-ESDI	EISA	1:1												(BUS MASTER), .5-4MB CACHE
DATA TECHNOLOGY	DTC-7180	ISA-ST412(MFM)	AT	1:1	2HD		2048	16	32	B	C	1/2	XT			POWER CONNECTOR ON BOARD

MANUFACTURER	MODEL NUMBER	INTERFACES	BUS SUPPORT	INTER LEAVE	--MAX-- HDS FDS	---MAX--- CYLS HDS	ECC LGN.	B C	--SIZE-- LGN. HGT.	-CONTROLLER FLOPPY	IC-- HARD	ADDITIONAL COMMENTS
DATA TECHNOLOGY	DTC-7187	ISA-ST412(RLL)	AT	1:1	2HD	2048 16		B C	1/2 XT			POWER CONNECTOR ON BOARD
DATA TECHNOLOGY	DTC-7280	ISA-ST412(MFM)	AT	1:1	2HD 2FD	2048 16	32	B	FULL XT			
DATA TECHNOLOGY	DTC-7287	ISA-ST412(RLL)	AT	1:1	2HD 2FD	2048 16		B C	FULL XT			
EMULEX	1B01	ISA-SCSI	PC,XT		7HD							HOST ADAPTER
EMULEX	1B02	ISA-SCSI	AT		7HD							HOST ADAPTER
EMULEX	MD21	SCSI-ESDI	NONE									DOES NOT PLUG INTO THE ISA BUS
EMULEX	MD25A	SCSI2-ESDI	NONE	1:1	4HD							DOES NOT PLUG INTO THE ISA BUS
EMULEX	MD26A	SCSI2/DIF-ESDI	NONE	1:1	4HD							DIF.SCSI,DOESN'T PLUG INTO BUS
EMULEX	MT-02	SCSI-QIC36	NONE									TAPE, DOESN'T PLUG INTO BUS
EVEREX	EV-332	ISA-ST412(MFM)	AT		2HD 2FD							
EVEREX	EV-346	ISA-ST412(MFM)	AT	1:1	2HD 2FD							
EVEREX	EV-390	ISA-ST412(MFM)	XT	5:1	2HD 2FD	1024 16		B	3/4 XT			
EVEREX	EV-391	ISA-ST412(MFM)	XT	5:1	2HD	1024 16		B	3/4 XT			
EVEREX	EV-392	ISA-ST412(RLL)	XT	5:1	2HD	1024 16		B	3/4 XT			
FARADAY	FE5140	ISA-FLOPPY	PC,XT		4FD				1/2 XT			FLOPPY DRIVES ONLY
FAST TECHNOLOGY	TNT-1000	ISA-ST412(MFM)	AT		2HD							
FAST TECHNOLOGY	TNT-1000R	ISA-ST412(RLL)	AT		2HD							
FAST TECHNOLOGY	TNT-1050	ISA-ST412(MFM)	AT		2HD 2FD							
FAST TECHNOLOGY	TNT-1050R	ISA-ST412(RLL)	AT		2HD 2FD							
FAST TECHNOLOGY	TNT-1250	ISA-ST412(MFM)	AT		2HD 2FD							FOR >10Mhz ISA BUS
FAST TECHNOLOGY	TNT-1250R	ISA-ST412(RLL)	AT		2HD 2FD							FOR >10Mhz ISA BUS
FAST TECHNOLOGY	TNT-1610	ISA-ST412(MFM)	AT		2HD 2FD							1-16MB CACHE
FAST TECHNOLOGY	TNT-2210	ISA-ESDI	AT	1:1	4HD 2FD			B	FULL AT			(BUS MASTER), 2-10MB CACHE
FAST TECHNOLOGY	TNT-2410	ISA-ESDI	AT	1:1	4HD 2FD			B	FULL AT			(BUS MASTER), 2-10MB CACHE
FAST TECHNOLOGY	TNT-2610	ISA-ESDI	AT	1:1	4HD 2FD			B	FULL AT			(BUS MASTER), 2-10MB CACHE
FAST TECHNOLOGY	TNT-3020	TNT-2x10 CARDS										2MB CACHE FOR 2x10 SERIES
FAST TECHNOLOGY	TNT-3040	TNT-2x10 CARDS										4MB CACHE FOR 2x10 SERIES
FAST TECHNOLOGY	TNT-3060	TNT-2x10 CARDS										6MB CACHE FOR 2x10 SERIES
FAST TECHNOLOGY	TNT-3080	TNT-2x10 CARDS										8MB CACHE FOR 2x10 SERIES
FAST TECHNOLOGY	TNT-3100	TNT-50x0 CARDS										0MB CACHE FOR 50x0 SERIES
FAST TECHNOLOGY	TNT-3120	TNT-50x0 CARDS										2MB CACHE FOR 50x0 SERIES

MANUFACTURER	MODEL NUMBER	INTERFACES	BUS SUPPORT	INTER LEAVE	--MAX-- HDs	FDs	---MAX--- CYLs	HDS	ECC LGN.	B	C	--SIZE-- LGN.	HGT.	-CONTROLLER FLOPPY	IC-- HARD	ADDITIONAL COMMENTS	PAGE 7
FAST TECHNOLOGY	TNT-3140	TNT-50x0 CARDS														4MB CACHE FOR 50x0 SERIES	
FAST TECHNOLOGY	TNT-3160	TNT-50x0 CARDS														6MB CACHE FOR 50x0 SERIES	
FAST TECHNOLOGY	TNT-3180	TNT-50x0 CARDS														8MB CACHE FOR 50x0 SERIES	
FAST TECHNOLOGY	TNT-3200	TNT-50x0 CARDS														10MB CACHE FOR 50x0 SERIES	
FAST TECHNOLOGY	TNT-3210	TNT-50x0 CARDS														12MB CACHE FOR 50x0 SERIES	
FAST TECHNOLOGY	TNT-4000	ISA-SCSI-1,2	AT				7HD			B	C	3/4	AT			(PIO), EXT.SCSI CONN.	
FAST TECHNOLOGY	TNT-4050	ISA-SCSI-1,2	AT				7HD 2FD			B	C	3/4	AT			(PIO), 4MB/20MB FLOPPYS	
FAST TECHNOLOGY	TNT-4100	ISA-SCSI-1,2	AT				7HD			B	C	3/4	AT			(PIO)	
FAST TECHNOLOGY	TNT-4150	ISA-SCSI-1,2	AT				7HD 2FD			B	C	3/4	AT			(PIO), 4MB/20MB FLOPPYS	
FAST TECHNOLOGY	TNT-5000	ISA-IDE(AT)	AT	1:1			2HD 2FD			B		FULL	AT			.5-4MB CACHE	
FAST TECHNOLOGY	TNT-5010	ISA-IDE(AT)	AT	1:1			2HD 2FD			B		FULL	AT			.5-4MB CACHE	
FAST TECHNOLOGY	TNT-5020	ISA-IDE(AT)	AT	1:1			2HD 2FD			B		FULL	AT			.5-4MB CACHE	
FAST TECHNOLOGY	TNT-5040	ISA-IDE(AT)	AT	1:1			2HD 2FD			B		FULL	AT			.5-4MB CACHE	
FAST TECHNOLOGY	TNT-6000	ISA-SCSI	AT				7HD			B	C					512KB CACHE	
FAST TECHNOLOGY	TNT-6100	ISA-SCSI	AT				7HD 2FD			B	C					512KB CACHE	
FAST TECHNOLOGY	TNT-6120	ISA-SCSI	AT				7HD 2FD			B	C					2MB CACHE	
FAST TECHNOLOGY	TNT-6140	ISA-SCSI	AT				7HD 2FD			B	C					4MB CACHE	
FUTURE DOMAIN	MCS-350	MCA-SCSI	MCA				7HD					FULL	MC	TMC-950		HOST ADAPTER	
FUTURE DOMAIN	MCS-600	MCA-SCSI-2F	MCA				7HD			B	C	HALF	MC	TMC-1800		(PIO), DUAL 8KB BUFFER	
FUTURE DOMAIN	MCS-700	MCA-SCSI-2F	MCA				7HD			B	C	FULL	MC	TMC-1800		(PIO), 8KB BUFFER,*OLD:TMC-950	
FUTURE DOMAIN	TMC-1650	ISA-SCSI-2F	AT				7HD			B	C	HALF	XT	TMC-1800		(PIO), 8KB DUAL BUFFER	
FUTURE DOMAIN	TMC-1660	ISA-SCSI-2F	AT				7HD			B	C	HALF	XT	TMC-1800		(PIO), 8KB BUFFER,*OLD:TMC-950	
FUTURE DOMAIN	TMC-1670	ISA-SCSI-2F	AT				7HD 2HD			B	C	HALF	XT	NS DP8473	TMC-1800	(PIO), 8KB DUAL BUFFER	
FUTURE DOMAIN	TMC-1680	ISA-SCSI-2F	AT				7HD 4FD			B	C	HALF	XT	NS DP8473	TMC-1800	(PIO), 8KB BUFFER,*OLD:TMC-950	
FUTURE DOMAIN	TMC-1760	EISA-SCSI-2F	EISA				7HD			B	C	HALF	AT	TMC-18C50		(PIO), 8KB BUFFER, 8-BIT BIOS	
FUTURE DOMAIN	TMC-1790	EISA-SCSI-2F	EISA				7HD			B	C	HALF	AT	TMC-18C50		(PIO), 8KB BUFFER, 16-BIT BIOS	
FUTURE DOMAIN	TMC-7000EX	EISA-SCSI-2	EISA				7HD			B	C	FULL	AT	WD 33C93B		(BUS MASTER)	
FUTURE DOMAIN	TMC-7000FASST2	ISA-SCSI	AT				7HD 2FD			B	C	FULL	AT	WD 37C65B	WD 33C93A	(BUS MASTER)	
FUTURE DOMAIN	TMC-830	ISA-SCSI	PC,XT,AT				7HD					1/2	XT	TMC-950		(PIO)	
FUTURE DOMAIN	TMC-841	ISA-SCSI	PC,XT,AT				7HD			B	C	1/2	XT	TMC-950		(PIO)	
FUTURE DOMAIN	TMC-841RL	ISA-SCSI	PC,XT,AT				7HD				C	1/2	XT	TMC-950		(PIO), NO BOOT BIOS	

MANUFACTURER	MODEL NUMBER	INTERFACES	BUS SUPPORT	INTER LEAVE	--MAX-- HDs	FDs	---MAX--- CYLS	HDS	ECC LGN.	B	C	--SIZE-- LGN.	HGT.	-CONTROLLER FLOPPY	IC-- HARD	ADDITIONAL COMMENTS		
FUTURE DOMAIN	TMC-845	ISA-SCSI	PC,XT,AT		7HD							C	1/2	XT	TMC-950	(PIO), NO BOOT BIOS		
FUTURE DOMAIN	TMC-850 [M]	ISA-SCSI	PC,XT,AT		7HD							B	C	1/2	XT	TMC-950	(PIO)	
FUTURE DOMAIN	TMC-860 [M]	ISA-SCSI	AT		7HD							B	C	1/2	XT	TMC-950	(PIO), POWER CONNECTOR	
FUTURE DOMAIN	TMC-870	ISA-SCSI	PC,XT,AT		7HD	4FD						3/4	XT		TMC-950	(PIO)		
FUTURE DOMAIN	TMC-871	ISA-SCSI	XT,AT		7HD	4FD									TMC-950	(PIO)		
FUTURE DOMAIN	TMC-875	ISA-SCSI	XT,AT		7HD	4FD						B	C	3/4	XT	TMC-950	(PIO)	
FUTURE DOMAIN	TMC-881	ISA-SCSI	AT		7HD	4FD						3/4	XT		TMC-950	(PIO)		
FUTURE DOMAIN	TMC-885 [M]	ISA-SCSI	AT		7HD	4FD						B	C	3/4	XT	NS DP8473	TMC-950	(PIO)
GSI	1495-05	ISA-ESDI	AT	1:1	4HD		2046		RS	B		3/4	XT				R/S ECC, CACHE, DISK SHADOWING	
GSI	1495-44-V	ISA-ESDI	AT	1:1	4HD	4FD	2046		RS	B		3/4	XT	NS DP8473			R/S ECC, CACHE, DISK SHADOWING	
GSI	1495-M4	ISA-ESDI*	AT	1:1	4HD		2046		RS	B		3/4	XT				R/S ECC, CACHE, DISK SHADOWING	
GSI	1533-11-V	ISA-FLOPPY	PC,XT,AT			4FD						B	C				2.88MB FLOPPY SUPPORT	
GSI	1533-18-V	ISA-IDE(AT)	AT		2HD							C						
GSI	1533-19-V	ISA-IDE(AT)	AT		2HD													
GSI	1533-21-V	ISA-IDE(AT)	AT		2HD	4FD						B					2.88MB FLOPPY SUPPORT	
GSI	EHD-10	ISA-EHD FLOPPY	AT			2FD						C	1/2	XT			2.88MB FLOPPY SUPPORT	
GSI	EHD-20	ISA-IDE(AT)	AT		2HD	2FD						1/2	XT				2.88MB FLOPPY SUPPORT	
GSI	EHD-21	ISA-IDE(AT)	AT		2HD	4FD						B	1/2	XT			2.88MB FLOPPY SUPPORT & BOOT	
GSI	EHD-2S	ISA-IDE(AT)	AT		HD	4FD						B	1/2	XT			2.88MB FLOPPY, SECURITY MODEL	
INTERPHASE	4810 BARRACUDA	EISA-SCSI-2	EISA		7HD							B	FULL		FUJ 87030		128KB BUFFER,2ND SCSI CHAN.OPT	
JC INFO SYSTEMS	1100-000	ISA-FLOPPY	XT,AT			2FD						1/2	XT				FLOPPY DRIVES ONLY	
JC INFO SYSTEMS	1110-000	ISA-ST412(MFM)	AT	1:1	2HD	2FD						1/2	XT					
JC INFO SYSTEMS	1120-000	ISA-IDE(AT)	AT	1:1	2HD	2FD						1/2	XT					
JC INFO SYSTEMS	1120-100	ISA-IDE(AT)	AT	1:1	2HD	2FD						1/2	XT				1-SERIAL, 1-PARALLEL PORT	
JC INFO SYSTEMS	1120-200	ISA-IDE(AT)	AT	1:1	2HD	2FD						1/2	XT				2-SERIAL, 1-PARALLEL PORT	
JC INFO SYSTEMS	2110-100	ISA-ST412(MFM)	AT	1:1	2HD	2FD						1/2	XT					
JC INFO SYSTEMS	2132-100	ISA-ESDI	AT	1:1	2HD	2FD							XT					
JETS CYBERNETICS	SURFBOARD XPe	MCA-SCSI	MCA												NCR		(DMA), DIF.SCSI, 128K-1M CACHE	
JETS CYBERNETICS	SURFBOARD XPe	EISA-SCSI	EISA												NCR		(DMA), DIF.SCSI, 128K-1M CACHE	
KALOK	KL-03	ISA-IDE(AT)	AT		2HD							C	1/2	XT				
KALOK	KL-03F	ISA-IDE(AT)	AT		2HD	2FD						C	1/2	XT			ALT. FLOPPY ADDRESS OPT.	

MANUFACTURER	MODEL NUMBER	INTERFACES	BUS SUPPORT	INTER LEAVE	--MAX-- HDs	FDs	---MAX--- CYLs	HDS	ECC LGN.	B	C	--SIZE-- LGN.	HGT.	-CONTROLLER FLOPPY	IC-- HARD	ADDITIONAL COMMENTS
KALOK	KL-03S	ISA-IDE(AT)	AT		2HD	2FD						C	1/2	XT		ALT.FLOPPY ADDR, 1-S,1-P PORT
KIMPSION	WA3-16	ISA-ST412(MFM)	AT	2:1	2HD	2FD	2048	16				3/4	XT		WD CHIPSET	
KIMPSION	WA6-V	ISA-ST412(MFM)	AT	1:1	2HD	2FD	2048	16				3/4	XT		WD CHIPSET	
KIMPSION	WA6-VR	ISA-ST412(RLL)	AT	1:1	2HD	2FD	2048	16		B		3/4	XT		WD CHIPSET	
KONAN	DJ-210	ISA-ST412(MFM)	PC		2HD											
KONAN	TNT-1000	ISA-ST412(MFM)	AT	1:1	2HD								XT			
KONAN	TNT-1050	ISA-ST412(MFM)	AT	1:1	2HD	2FD							XT			
KONAN	TNT-ESDI	ISA-ESDI	AT	1:1	2HD											2-10MB CACHE
LARK ASSOCs.	LRK-330	ISA-ESDI	AT	1:1	2HD					B			XT			2-64KB CACHE
LARK ASSOCs.	LRK-331	ISA-ESDI	AT	1:1	2HD	2FD				B			XT			2-64KB CACHE
LAURA TECH.	TNT-6000	EISA-SCSI-2	EISA		7HD					B	C					.5-80MB CACHE, 68340 CPU
LOMAS DATA PROD.	LDP CACHE II	ISA-SCSI-2	AT		7HD	2FD				B	C	FULL	AT	i82077	NCR 53C90A	1-16MB CACHE
LOMAS DATA PROD.	LDP CACHE III	ISA-SCSI-2	AT		7HD	4FD				B	C	FULL	AT	i82077AA-1	NCR 53C90A	1-2MB CACHE
LONGSHINE	LCS-6210ASIC	ISA-ST412(MFM)	XT		2HD		1024	16					XT			
LONGSHINE	LCS-6210D	ISA-ST412(MFM)	XT		2HD		1024	16					XT			
LONGSHINE	LCS-6210W	ISA-ST412(MFM)	XT		2HD		1024	16					XT		WD GEN2	
LONGSHINE	LCS-6217	ISA-ST412(RLL)	XT		2HD		1024	8					XT			
LONGSHINE	LCS-6220	ISA-ST412(MFM)	XT		2HD	2FD	1024	16					XT			
LONGSHINE	LCS-6220ASIC	ISA-ST412(MFM)	AT	2:1	2HD											
LONGSHINE	LCS-6610F	ISA-FLOPPY	XT,AT			2FD							XT			FLOPPY DRIVES ONLY
LONGSHINE	LCS-6611	ISA-ST412(MFM)	AT	1:1	2HD		1024	16							WD CHIPSET	WD1006-WA2 COMPATIBLE
LONGSHINE	LCS-6617	ISA-ST412(RLL)	AT	2:1	2HD											
LONGSHINE	LCS-6620ASIC	ISA-ST412(MFM)	AT	2:1	2HD	2FD										
LONGSHINE	LCS-6622 [W]	ISA-ST412(MFM)	AT	1:1	2HD	2FD	2048	16							WD CHIPSET	WD1006-WA2 COMPATIBLE
LONGSHINE	LCS-6622NCL	ISA-ST412(MFM)	AT	1:1	2HD	2FD									NCL CHIPSET	
LONGSHINE	LCS-6623	ISA-IDE(AT)	AT		2HD	2FD						C				
LONGSHINE	LCS-6624	ISA-IDE(AT)	AT		2HD	2FD						C				2-SERIAL, 1-PARALLEL PORT
LONGSHINE	LCS-6624G	ISA-IDE(AT)	AT		2HD	2FD						C				2-SER, 1-PAR, 1-GAME PORT
LONGSHINE	LCS-6627	ISA-ST412(RLL)	AT	2:1	2HD	2FD										
LONGSHINE	LCS-6630	ISA-SCSI	AT		6HD					B						
LONGSHINE	LCS-6630F	ISA-SCSI	AT		6HD	2FD				B						

MANUFACTURER	MODEL NUMBER	INTERFACES	BUS SUPPORT	INTER LEAVE	--MAX-- HDS FDS	---MAX--- CYLS HDS	ECC LGN.	B C	--SIZE-- LGN. HGT.	-CONTROLLER FLOPPY	IC-- HARD	ADDITIONAL COMMENTS
LONGSHINE	LCS-6631	ISA-SCSI	AT		6HD			B				CD ROM BIOS
LONGSHINE	LCS-6631F	ISA-SCSI	AT		6HD 2FD			B				CD ROM BIOS
LONGSHINE	LCS-6632	ISA-SCSI/ST412M	AT		6HD			B				CD ROM BIOS, INC. ST412 MFM
LONGSHINE	LCS-6812F	ISA-FLOPPY	XT,AT		2FD				XT			SECONDARY FLOPPY CONTROLLER
LONGSHINE	LCS-6814F	ISA-FLOPPY	XT,AT		4FD				XT			FLOPPY DRIVES ONLY
LONGSHINE	LCS-6815F	ISA-FLOPPY	XT,AT		4FD				XT			2.88MB FLOPPY SUPPORT
LONGSHINE	LCS-6818EV1	ISA-QIC-02	XT,AT						XT			QIC-02 TAPE INTERFACE
LONGSHINE	LCS-6821N-H	ISA-SCSI	XT,AT		2HD			B C	XT			
LONGSHINE	LCS-6821N-T	ISA-SCSI(TAPE)	XT,AT		2HD			B	XT			QIC-02 TAPE & SCSI INTERFACE
MACROTRON SYSTEMS	MSI-2010	ISA-SCSI-2	AT		7HD 2FD			B C	1/2 XT	SPI300/16	NS DP8473V	
MANZANTA MICROSYS	3RD INTN. MUX	ISA-FLOPPY	PC,XT,AT		3FD				1/2 XT			FLOPPY DRIVES ONLY
MANZANTA MICROSYS	HI-DENS.CONTR.	ISA-FLOPPY	PC,XT		4FD				1/2 XT			FLOPPY DRIVES ONLY
MANZANTA MICROSYS	MUX ADAPT.CARD	ISA-FLOPPY	PC,XT,AT		2FD				1/2 XT			FLOPPY DRIVES ONLY
MAPLE SYSTEMS	MC-1165A	ISA-ESDI	AT	1:1	2HD 2FD	4096 16	56	B	3/4 XT	NS DP8473V		25MHZ CHANNEL, 64KB CACHE
MAPLE SYSTEMS	MC-1166	ISA-ESDI	AT			4096 16		B				256B/SECTOR ONLY, 64KB CACHE
MAPLE SYSTEMS	MC-1175	ISA-ESDI	AT		2HD 2FD	4096 16	56	B	2/3 XT	NS DP8473V		>528MB SUPPORT, 64KB CACHE
MAPLE SYSTEMS	MC-2068	ISA-IDE(AT)	AT		2HD 2FD	4096 16		B	3/4 AT	NS DP8473V		>528MB SUPPORT, .5-8MB CACHE
MAPLE SYSTEMS	MC-2068A	ISA-IDE(AT)	AT		2HD 2FD	4096 16		B	3/4 AT	NS DP8473V		>528MB SUPPORT, 2-16MB CACHE
MAPLE SYSTEMS	MC-2078	ISA(LB)-IDE(AT)	AT(VESA)		2HD 2FD	4096 16		B	3/4 AT	NS DP8473V		>528MB SUPPORT, 2-8MB CACHE
MAPLE SYSTEMS	MC-2078A	ISA(LB)-IDE(AT)	AT(VESA)		2HD 2FD	4096 16		B	3/4 AT	NS DP8473V		>528MB SUPPORT, 2-32MB CACHE
MAPLE SYSTEMS	MC-4000	ISA-SCSI	AT		9HD 2FD			B	2/3 AT	NS DP8473V		SCSI & ST412, 2-32MB CACHE
MAXTOR COLORADO	AKF (AT-FIB)	ISA-IDE(AT)	AT		2HD 2FD				1/2 XT			
MAXTOR COLORADO	AKPS/2 (PS/2)	PS/2-IDE(AT)	PS/2(30)		1HD			B	1/2 XT			PS/2 MODEL 30
MAXTOR COLORADO	AKS (AT-SIB)	ISA-IDE(AT)	AT		2HD				1/2 XT			
MICRONET TECH.	HA-01/PC	ISA-SCSI-2	AT		7HD				3/4			
MICRONET TECH.	HA-05/PC	MCA-SCSI-2	MCA		7HD				FULL			
MICRONET TECH.	HA-06/PC	EISA-SCSI-2	EISA		7HD				3/4			
MICRO SOLUTIONS	COMPATICARD	ISA-FLOPPY	PC,XT,AT		4FD				1/2 XT			FLOPPY DRIVES ONLY
MICRO SOLUTIONS	COMPATICARD II	ISA-FLOPPY	PC,XT,AT		2FD				1/2 XT			FLOPPY DRIVES ONLY
MICRO SOLUTIONS	COMPATICARD IV	ISA-FLOPPY	PC,XT,AT		4FD				1/2 XT			FLOPPY DRIVES ONLY
MITSUBISHI	MW-5C1	ESDI-SCSI	NONE									FOR MW-5D1 CDROM DRIVE ONLY

MANUFACTURER	MODEL NUMBER	INTERFACES	BUS SUPPORT	INTER LEAVE	--MAX-- Hds Fds	---MAX-- CYLs HDS	ECC LGN.	B C	--SIZE-- LGN. HGT.	-CONTROLLER FLOPPY	IC-- HARD	ADDITIONAL COMMENTS
MYLEX	DC-376	32BIT-SCSI	32BIT AT	1:1	7HD				FULL XT			(DMA), 32-BIT, 4MB CACHE
MYLEX	DCE-376	EISA-SCSI	EISA	1:1	7HD 2FD			B	FULL AT	WD 37C65B	NCR 53C90A	(BUS MASTER), .5-8MB CACHE
MYLEX	DNE-960	EISA-SCSI-2F	EISA		7HD				FULL			(BUS MASTER), 128KB CACHE
NCL AMERICA	NCL-3016	SCSI-ST412(MFM)	NONE		2HD	2048 16		C				DOES NOT PLUG INTO ISA BUS
NCL AMERICA	NCL-3026	SCSI-ST412(RLL)	NONE		2HD	2048 16		C				DOES NOT PLUG INTO ISA BUS
NCL AMERICA	NCL-500	ISA-SCSI	XT,AT		7HD				1/2 XT			HOST ADAPTER
NCL AMERICA	NCL-5034	ISA-FLOPPY	PC,XT,AT		2FD				1/2 XT			FLOPPY DRIVES ONLY
NCL AMERICA	NCL-5235	ISA-ST412(RLL)	AT		2HD 2FD	2048 16			1/2 XT			
NCL AMERICA	NCL-5236	ISA-ST412(RLL)	AT		2HD	2048 16			1/2 XT			
NCL AMERICA	NCL-5255	ISA-ST412(RLL)	AT	1:1	2HD 2FD	2048 16			1/2 XT			
NCL AMERICA	NCL-5256	ISA-ST412(RLL)	AT	1:1	2HD	2048 16			1/2 XT			
NCL AMERICA	NCL-5335	ISA-ESDI	AT	1:1	2HD 2FD	2048 16			3/4 XT			
NCL AMERICA	NCL-5336	ISA-ESDI	AT	1:1	2HD	2048 16			1/2 XT			
NCL AMERICA	NCL-5355	ISA-ESDI	AT	1:1	2HD 2FD	2048 16			3/4 XT			16-64KB CACHE, 4096 CYLs (?)
NCL AMERICA	NCL-5356	ISA-ESDI	AT	1:1	2HD	2048 16			1/2 XT			
NCL AMERICA	NCL-540	ISA-SCSI	XT,AT							NCR 53C400		(PIO) PROGRAMMED I/O
NCL AMERICA	NCL-5425	ISA-ST412(MFM)	AT		2HD 2FD	2048 16			1/2 XT			
NCL AMERICA	NCL-5426	ISA-ST412(MFM)	AT		2HD	2048 16			1/2 XT			
NCL AMERICA	NCL-5455	ISA-ST412(MFM)	AT		2HD 2FD	2048 16			1/2 XT			
NCL AMERICA	NCL-5456	ISA-ST412(MFM)	AT	1:1	2HD	2048 16			1/2 XT			
NCL AMERICA	NCL-5525	ISA-ST412(MFM)	AT		2HD 2FD	2048 16			1/2 XT			
NCL AMERICA	NCL-600	MCA-SCSI	MCA							NCR 53C94		(DMA)
NCR	ADP-31S	ISA-SCSI	XT,AT							NCR 5380		(DMA)
NCR	ADP-37	MCA-SCSI-2	MCA3		7HD			B C	FULL MC			(BUS MASTER)
NCR	ADP-92	ISA-SCSI RAID*	AT		*HD							*RAID 0,1,3,5, *5 SCSI PORTS
NEC	CDINT338	LPT1-LPT1/SCSI	PRINTER		7HD							CONN.TO LPT.PORT,(TRANTOR 338)
NEC	CDMA001	MAC-SCSI	MAC		6HD							FOR MACINTOSH
NEC	CDPS002	MCA-SCSI	MCA		7HD							FOR PS/2
NEC	CDXT002	ISA-SCSI	XT,AT		7HD							
NEC	DA501	ESDI-SMD	NONE		1HD	4096						FOR NEC 5600 CDROMS ONLY
NEC	DA521	ESDI-IPI-2	NONE		1HD							FOR NEC 5600 CDROMS ONLY

MANUFACTURER	MODEL NUMBER	INTERFACES	BUS SUPPORT	INTER LEAVE	--MAX-- HDs	FDs	---MAX--- CYLS	HDS	ECC LGN.	B	C	--SIZE-- LGN.	HGT.	-CONTROLLER FLOPPY	IC-- HARD	ADDITIONAL COMMENTS
NOVELL	NE-3200	EISA-SCSI			7HD											
PERCEPTIVE SOLS.	EASYCACHE															4MB MAXIMUM CACHE
PERCEPTIVE SOLS.	EASYCACHE PRO															16MB MAXIMUM CACHE
PERCEPTIVE SOLS.	ESDI	PRO.-ESDI	AT	1:1	2HD		2048	16		B	C					ADD-ON FOR SPU (4-MAXIMUM)
PERCEPTIVE SOLS.	HS16 / 1600SPU	ISA-PROPRIETARY	AT	1:1								FULL				MAIN SPU BOARD, 4MB MAX.CACHE
PERCEPTIVE SOLS.	HS8 / 816SPU	ISA-PROPRIETARY	AT									FULL				MAIN SPU BOARD, 4MB MAX.CACHE
PERCEPTIVE SOLS.	IDE	PRO.-IDE(AT)	AT	1:1	2HD											ADD-ON FOR SPU (4-MAXIMUM)
PERCEPTIVE SOLS.	MFM	PRO.-ST412(MFM)	AT	1:1	2HD		2048	16		B	C					ADD-ON FOR SPU (4-MAXIMUM)
PERCEPTIVE SOLS.	QUICKCACHE	ISA-IDE(AT)	AT		2HD	2FD				B						.5-8.5MB CACHE
PERCEPTIVE SOLS.	RLL	PRO.-ST412(RLL)	AT	1:1	2HD		2048	16		B	C					ADD-ON FOR SPU (4-MAXIMUM)
PERCEPTIVE SOLS.	SCSI	PRO.-SCSI	AT	1:1	7HD											ADD-ON FOR SPU (4-MAXIMUM)
PERFORM. TECHS.	PT-SCS350	SCSI-FLOPPY	NONE			4FD					C					DOES NOT PLUG INTO ISA BUS
PERSTOR SYSTEMS	ADRC-9008	ISA-ST412*	XT,AT	3:1	2HD		1024	15	56	B		1/2	XT			*ADRT(ARLL), 32-SECTORS/TRACK
PERSTOR SYSTEMS	PS180-16FN	ISA-ST412*	AT	3:1	2HD	2FD	2048	15	56	B		FULL	AT			*ADRT(ARLL), 31-SECTORS/TRACK
PERSTOR SYSTEMS	PS180-8XT/AT	ISA-ST412*	XT,AT	3:1	2HD		1024	15	56	B		FULL	XT			*ADRT(ARLL), 31-SECTORS/TRACK
PERSTOR SYSTEMS	PS200-16F	ISA-ST412*	AT	3:1	2HD	2FD	2048	15	56	B		FULL	AT			*ADRT(ARLL), 34-SECTORS/TRACK
PERSTOR SYSTEMS	PS200-8	ISA-ST412*	XT,AT	3:1	2HD				56	B		FULL	XT			*ADRT(ARLL), 34-SECTORS/TRACK
PIONEER	DD-C5001	SCSI-IDI (CD)	NONE		4CD											PROPRIETARY, DOESN'T PLUG-IN
PIONEER	DD-C5002	ISA-SCSI & IDI	AT		2HD					B		FULL	XT			PROPRIETARY, INCS 2 SCSI PORTS
PIONEER	DDI-80AT	ISA-SCSI	XT,AT		2HD							1/2	XT			REQ'S DDS-81AT/51AT SOFTWARE
PROCOM TECHNOLOGY	CC ENABLER	ISA-SCSI-2			7HD							1/2				8MB MAXIMUM CACHE
PROCOM TECHNOLOGY	CC-8 ENABLER	ISA-SCSI-2			7HD							1/2				(PIO), 2MB MAXIMUM CACHE
PROCOM TECHNOLOGY	CC-16 ENABLER	ISA-SCSI-2			7HD							FULL				(PIO), 10MB MAXIMUM CACHE
PROCOM TECHNOLOGY	MC ENABLER	MCA-SSI-2			7HD							FULL				(DMA), 2MB MAXIMUM CACHE
PROCOM TECHNOLOGY	ISA XELERATOR	ISA-SCSI			7HD											(BUS MASTER)
PROCOMP USA	M-DCB	ISA-SCSI	AT		2HD					B	C	FULL	AT			FOR NOVELL LANS, BIOS OPTION
PROCOMP USA	M-DCB/2	MCA-SCSI	MCA		2HD					B	C	FULL				FOR NOVELL LANS, BIOS OPTION
PROMISE TECH.	DC-2030	ISA-IDE(AT)	AT		2HD	2FD	2048	16		B	C	FULL	AT	SMC 37C65A		.5-4MB CACHE, 12.5MHz ISA BUS
PROMISE TECH.	DC-2031	ISA-IDE(AT)	AT		2HD	2FD	2048	16		B	C	FULL	AT	NS DP8473		.5-16MB CACHE, 16MHz ISA BUS
PROMISE TECH.	DC-2032	ISA-IDE(AT)	AT		4HD	2FD	2048	16		B	C	FULL	AT	NS DP8473		.5-16MB CACHE, 16MHz ISA BUS
PROMISE TECH.	DC-2040	ISA-SCSI	AT		7HD	2FD				B	C	FULL	AT	SMC 37C65A NCR 53C94		.5-16MB CACHE, 16MHz ISA BUS



MANUFACTURER	MODEL NUMBER	INTERFACES	BUS SUPPORT	INTER LEAVE	--MAX-- HDS FDS	---MAX--- CYLS HDS	ECC LGN.	B C	--SIZE-- LGN. HGT.	-CONTROLLER FLOPPY	IC-- HARD	ADDITIONAL COMMENTS
PROMISE TECH.	DC-3030	EISA-IDE(AT)	EISA		4HD 2FD	2048 16		B C	FULL AT			.5-16MB CACHE
PROMISE TECH.	DC-3040	EISA-SCSI	EISA		7HD 2FD			B C	FULL AT			.5-16MB CACHE
PROMISE TECH.	DC-99	ISA-IDE(AT)	AT		2HD 2FD	2048 16		B	1/2 XT			.5-8.5MB CACHE, 16MHz BUS
PROMISE TECH.	DC-100	ISA-IDE(AT)	AT		2HD 2FD	2048 16		B	2/3 XT			.5-8.5MB CACHE, 16MHz BUS
PTI	PTI-151	ISA-FLOPPY	XT,AT		2HD							FLOPPY DRIVES ONLY
PTI	PTI-158	ISA-FLOPPY	XT,AT		4FD							FLOPPY DRIVES ONLY
PTI	PTI-215	ISA-IDE(AT)	AT		2HD 2FD							
PTI	PTI-217	ISA-IDE(AT)	AT		2HD 2FD							2-SER,1-PAR,1-GAME PORT
RANCHO TECHNOLOGY	RT-10-AT	ISA-SCSI-2	AT		7HD				FULL XT		WD 33C93	(BUS MASTER)
RANCHO TECHNOLOGY	RT-10-XT	ISA-SCSI	XT,AT		7HD				1/2 XT			(PIO)
RANCHO TECHNOLOGY	RT-100-XT	ISA-SCSI	XT,AT		7HD 4FD				1/2 XT			(PIO)
RANCHO TECHNOLOGY	RT-1000-MC	MCA-SCSI	MCA		7HD				MC		NCR 53C400	(PIO), 2KB BUFFER
RANCHO TECHNOLOGY	RT-1000A	ISA-SCSI	XT,AT		7HD				1/2 XT		NCR 53C400	(PIO)
RANCHO TECHNOLOGY	RT-1000A-4	ISA-SCSI	XT,AT		7HD 4FD				1/2 XT	WD 37C65B	NCR 53C400	(PIO)
RANCHO TECHNOLOGY	RT-1600	ISA-SCSI	AT		7HD							(DMA or PIO)
RELAX TECH.	T-100	ISA-SCSI	PC,XT,AT									(PIO)
RELAX TECH.	T-128	ISA-SCSI	PC,XT,AT								NCR 5380	(DMA)
RELAX TECH.	T-200	MCA-SCSI	MCA									(PIO)
RMT SYSTEMS	RMT2001-F2H2	ISA-ST412(MFM)	XT		2HD 2FD			B				
SEAGATE TECH.	ST01	ISA-SCSI	PC,XT,AT		2HD	1024 16		B C	1/2 XT		TMC-900,950	(PIO)
SEAGATE TECH.	ST02	ISA-SCSI	PC,XT,AT		2HD 2FD	1024 16		B C	1/2 XT	NS DP8473	TMC-900,950	(PIO)
SEAGATE TECH.	ST05X	ISA-IDE(XT)	XT		2HD	1024 16		B	1/2 XT			POWER CONNECTOR ON BOARD
SEAGATE TECH.	ST07A	ISA-IDE(AT)	AT		2HD	1024 16			1/2 XT			POWER CONNECTOR ON BOARD
SEAGATE TECH.	ST08A	ISA-IDE(AT)	AT		2HD 2FD	1024 16			1/2 XT			POWER CONNECTOR ON BOARD
SEAGATE TECH.	ST11M	ISA-ST412(MFM)	PC,XT,AT		2HD	1024 16		B	1/2 XT			POWER CONNECTOR ON BOARD
SEAGATE TECH.	ST11R	ISA-ST412(RLL)	PC,XT,AT		2HD	1024 16		B	1/2 XT			POWER CONNECTOR ON BOARD
SEAGATE TECH.	ST21M	ISA-ST412(MFM)	AT	1:1	2HD	1024 16		B	1/2 XT			POWER CONNECTOR ON BOARD
SEAGATE TECH.	ST21R	ISA-ST412(RLL)	AT	1:1	2HD	1024 16		B	1/2 XT			POWER CONNECTOR ON BOARD
SEAGATE TECH.	ST22M	ISA-ST412(MFM)	AT		2HD 2FD	1024 16		B	1/2 XT			POWER CONNECTOR ON BOARD
SEAGATE TECH.	ST22R	ISA-ST412(RLL)	AT		2HD 2FD	1024 16		B	1/2 XT			POWER CONNECTOR ON BOARD
SILICON VALLEY	ADP-20	ISA-IDE(AT)	AT		2HD				1/2 XT			POWER CONNECTOR ON BOARD

MANUFACTURER	MODEL NUMBER	INTERFACES	BUS SUPPORT	INTER LEAVE	--MAX-- HDS FDS	---MAX--- CYLS HDS	ECC LGM.	B C	--SIZE-- LGN. HGT.	-CONTROLLER FLOPPY	IC-- HARD	ADDITIONAL COMMENTS
SILICON VALLEY	ADP-20F	ISA-IDE(AT)	AT		2HD 2FD				1/2 XT	WD 37C65		POWER CONNECTOR ON BOARD
SILICON VALLEY	ADP-50	ISA-IDE(AT)	XT		2HD			B	1/2 XT			RUNS IDE(AT) DRIVES IN AN XT
SILICON VALLEY	ADP-60	ISA-IDE(AT)	AT		2HD			B C	1/2 XT			
SILICON VALLEY	ADP-60F	ISA-IDE(AT)	AT		2HD 4FD			B C	1/2 XT			
SILICON VALLEY	GOLD-MINE 1100	ISA-SCSI	PC,XT,AT		7HD 2FD			B	1/2 XT	WD 37C65	NCR 5380	
SMS TECHNOLOGIES	OMTI 20C											
SMS TECHNOLOGIES	OMTI 20D											
SMS TECHNOLOGIES	OMTI 3127A-2D	SCSI-RLL										
SMS TECHNOLOGIES	OMTI 510HAX	ISA-SCSI	PC,XT,AT		7HD							
SMS TECHNOLOGIES	OMTI 512-HA3	ISA-SCSI (OCS)										
SMS TECHNOLOGIES	OMTI 512-HA7	ISA-SCSI			7HD							
SMS TECHNOLOGIES	OMTI 5510	ISA-ST412(MFM)	XT		2HD				XT			-0,-1,-2,-3 OPTIONS
SMS TECHNOLOGIES	OMTI 5520A	ISA-ST412(MFM)	XT		2HD							
SMS TECHNOLOGIES	OMTI 5526	ISA-ST412(MFM)	XT		2HD							
SMS TECHNOLOGIES	OMTI 5527A	ISA-ST412(RLL)	XT		2HD				1/2 XT			
SMS TECHNOLOGIES	OMTI 6510	ISA-ESDI	XT		2HD							
SMS TECHNOLOGIES	OMTI 810	ISA-SCSI	AT		7HD			B C	FULL XT			(PIO or DMA)
SMS TECHNOLOGIES	OMTI 812	ISA-SCSI	AT		7HD			B C	FULL XT		OMTI 5086	(PIO or DMA), EXT. CONNECTOR
SMS TECHNOLOGIES	OMTI 8120	ISA-ST412(MFM)	AT	1:1	2HD				1/2			
SMS TECHNOLOGIES	OMTI 8127	ISA-ST412(RLL)	AT		2HD				1/2			
SMS TECHNOLOGIES	OMTI 8130	ISA-ST412(MFM)	AT	2:1	2HD	2048 16 32			1/2 XT			
SMS TECHNOLOGIES	OMTI 8151	ISA-ST412(MFM)	AT	1:1	2HD	2048 16 32	B		1/2 XT			
SMS TECHNOLOGIES	OMTI 8157	ISA-ST412(RLL)	AT	1:1	2HD	2048 16 48	B		1/2 XT			
SMS TECHNOLOGIES	OMTI 820	ISA-SCSI			7HD 2FD			B C	FULL XT			(PIO or DMA)
SMS TECHNOLOGIES	OMTI 822	ISA-SCSI	AT		7HD 2FD			B C	FULL XT		OMTI 5086	(PIO or DMA), EXT. CONNECTOR
SMS TECHNOLOGIES	OMTI 8230	ISA-ST412(MFM)	AT	2:1	2HD 2FD	2048 16 32			1/2 XT			
SMS TECHNOLOGIES	OMTI 8247	ISA-ST412(RLL)	AT	1:1	2HD 2FD	2048 16			FULL XT			
SMS TECHNOLOGIES	OMTI 8250	ISA-ST412(MFM)	AT	1:1	2HD 2FD	2048 16 32	B		1/2 XT			
SMS TECHNOLOGIES	OMTI 8257	ISA-ST412(RLL)	AT	1:1	2HD 2FD	2048 16 48	B		1/2 XT			
SMS TECHNOLOGIES	OMTI 8620	ISA-ESDI	AT	1:1	2HD 2FD							
SMS TECHNOLOGIES	OMTI 8627	ISA-ESDI	AT	1:1	2HD 2FD							

MANUFACTURER	MODEL NUMBER	INTERFACES	BUS SUPPORT	INTER LEAVE	--MAX-- HDS FDS	---MAX--- CYLS HDS	ECC LGN.	B	C	--SIZE-- LGN. HGT.	-CONTROLLER FLOPPY	IC-- HARD	ADDITIONAL COMMENTS
SMS TECHNOLOGIES	OMTI 8627A	ISA-ST412(RLL)	AT		2HD 2FD								
SMS TECHNOLOGIES	OMTI 8630	ISA-ESDI	AT	1:1	2HD 2FD	2048 16	56	B		FULL XT			32KB CACHE
SMS TECHNOLOGIES	OMTI 8631	ISA-ESDI	AT	1:1	2HD	2048 16	56	B		FULL XT			32KB CACHE
SMS TECHNOLOGIES	OMTI 8640	ISA-ESDI	AT	1:1	2HD 2FD	2048 16	56	B		FULL XT			32KB CACHE, 15Mbps
SMS TECHNOLOGIES	OMTI 8641	ISA-ESDI	AT	1:1	2HD	2048 16	56	B		FULL XT			32KB CACHE, 15Mbps
SMS TECHNOLOGIES	OMTI 8650	ISA-ESDI	AT	1:1	2HD 2FD			B		FULL XT			32KB CACHE, 24Mbps
SOTA	FLOPPY I/O +	ISA-FLOPPY	PC,XT		4FD					1/2 XT			2-SERIAL, 2-PARALLEL PORTS
SPECIALTY DEV.	400 (ESDI)	ISA-ESDI	AT	1:1	2HD 2FD	2048 16	56	B		FULL AT			.5-4MB CACHE
SPECIALTY DEV.	400 (IDE)	ISA-IDE(AT)	AT	1:1	2HD 2FD			B		FULL AT			.5-4MB CACHE, 64KB BUFFER
SPECIALTY DEV.	400 (MFM)	ISA-ST412(MFM)	AT	1:1	2HD 2FD	2048 16		B		FULL AT			.5-4MB CACHE
SPECIALTY DEV.	400 (RLL)	ISA-ST412(RLL)	AT	1:1	2HD 2FD	2048 16		B		FULL AT			.5-4MB CACHE
SPECIALTY DEV.	400 (SCSI)	ISA-SCSI-2	AT		2HD 2FD			B		FULL AT			.5-4MB CACHE, 32KB BUFFER
STB SYSTEMS	POWERDRIVE IDE	ISA-IDE(AT)	AT		2HD								
STB SYSTEMS	POWERDRIVE MFM	ISA-ST412(MFM)	AT		2HD 2FD								32KB CACHE, OPT. 2-S,1-P PORTS
STB SYSTEMS	POWERDRIVE RLL	ISA-ST412(RLL)	AT		2HD 2FD								32KB CACHE, OPT. 2-S,1-P PORTS
STORAGE PLUS	SCSI-AT	ISA-SCSI	AT		7HD 2FD			B	C	3/4 XT	NCL 2020	NCR 53C80	(PIO)
STORAGE PLUS	SP1-300	ISA-SCSI-2	AT		7HD 2FD			B	C	1/2 XT	NS DP8473	SP1300/16	(DMA), 16-BIT
STORAGE RESEARCH	SR-9	ISA-SCSI	PC,XT,AT		7HD 2FD			B		1/2 XT			(PIO), SINGLE SPEED FLOPPYS
TEGA TECHNOLOGIES	SM-911S	ISA-SCSI	PC,XT,AT		7HD 2FD			B		1/2 XT			(PIO), SINGLE SPEED FLOPPYS
TRANTOR SYSTEMS	T100	ISA-SCSI	PC,XT,AT		7HD			* C		1/2 XT			(DMA), *OPTIONAL
TRANTOR SYSTEMS	T128	ISA-SCSI	AT		7HD			B	C	1/2 XT		NCR 5380	(DMA)
TRANTOR SYSTEMS	T128F	ISA-SCSI	AT		7HD 4FD			B	C	1/2 XT	NS DP8473	NCR 5380	(DMA)
TRANTOR SYSTEMS	T160	ISA-SCSI	AT		7HD								(PIO)
TRANTOR SYSTEMS	T160F	ISA-SCSI	AT		7HD 2FD								(PIO)
TRANTOR SYSTEMS	T130	ISA-SCSI	PC,XT,AT		7HD								(PIO)
TRANTOR SYSTEMS	T228	MCA-SCSI	MCA B		7HD			B	C	1/2 MC		NCR 5380	(PIO)
TRANTOR SYSTEMS	T260	MCA-SCSI	MCA 16		7HD					MC			(PIO)
TRANTOR SYSTEMS	T338	LPT1-LPT1/SCSI	PRINTER		7HD								CONNECTS TO PRINTER PORT
TRANTOR SYSTEMS	T348	LPTx-LPTx/SCSI	PRINTER		7HD								CONNECTS TO PRINTER PORT
ULTRASTOR	ULTRA 12C	ISA-ESDI	AT	1:1	2HD 3FD	4096 16	56	B	C	FULL XT			.5-16MB CACHE, 20Mb/sec.
ULTRASTOR	ULTRA 12F	ISA-ESDI	AT	1:1	2HD 3FD	4096 16	56	B	C	3/4 XT			32KB CACHE, 24Mb/sec.

MANUFACTURER	MODEL NUMBER	INTERFACES	BUS SUPPORT	INTER LEAVE	--MAX-- HDS FDS	---MAX--- CYLS HDS	ECC LGN.	B C	--SIZE-- LGN. HGT.	-CONTROLLER FLOPPY	IC-- HARD	ADDITIONAL COMMENTS
ULTRASTOR	ULTRA 14C	ISA-SCSI	AT		7HD						NCR	(DMA), 512KB CACHE
ULTRASTOR	ULTRA 14F	ISA-SCSI-2	AT		7HD				FULL		NCR	(DMA), 64KB CACHE
ULTRASTOR	ULTRA 15C	ISA-IDE(AT)	AT	1:1	2HD 2FD			B C				1-8MB CACHE, DISK MIRRORING
ULTRASTOR	ULTRA 22C	EISA-ESDI	EISA	1:1	2HD	4096 16	56	B C	FULL AT			.5-4MB CACHE, 24Mb/sec.
ULTRASTOR	ULTRA 24F	EISA-SCSI-2F	EISA		7HD 3FD			B C	FULL AT			64KB CACHE
WESTERN DIGITAL	ADSI-D215S	SCSI-ESDI	NONE		2HD							DOES NOT PLUG INTO ISA BUS
WESTERN DIGITAL	WD1001-WAH	CPU-ST412(MFM)	NONE		2HD							DOES NOT PLUG INTO ISA BUS
WESTERN DIGITAL	WD1002-27X	ISA-ST412(RLL)	PC,XT,AT		2HD	1024 16		B C	1/2 XT			POWER CONNECTOR ON BOARD
WESTERN DIGITAL	WD1002A-27X	ISA-ST412(RLL)	PC,XT,AT		2HD	1024 16	56	B	1/2 XT			SUPERBIOS
WESTERN DIGITAL	WD1002A-FOX	ISA-FLOPPY	XT,AT		*FD			*	1/2 XT			*OPT#1:2F,#2:4F,#4:(#2&BIOS)
WESTERN DIGITAL	WD1002A-WX1	ISA-ST412(MFM)	PC,XT,AT		2HD	1024 16		B C	1/2 XT			POWER CONNECTOR ON BOARD
WESTERN DIGITAL	WD1002S-SHD	SASI-ST412(MFM)	NONE		2HD							DOES NOT PLUG INTO ISA BUS
WESTERN DIGITAL	WD1003-RA2	ISA-ST412(RLL)	AT	3:1	2HD 2FD	2048 16			FULL AT			
WESTERN DIGITAL	WD1003-RAH	ISA-ST412(RLL)	AT	3:1	2HD	2048 16			FULL AT			SETTINGS INCLUDED FOR COMPAQ
WESTERN DIGITAL	WD1003-WA2	ISA-ST412(MFM)	AT	3:1	2HD 2FD	2048 16		B	FULL AT			
WESTERN DIGITAL	WD1003-WAH	ISA-ST412(MFM)	AT	3:1	2HD	2048 16						SETTINGS INCLUDED FOR COMPAQ
WESTERN DIGITAL	WD1003A-RA2	ISA-ST412(RLL)	AT	2:1	2HD 2FD						XT	
WESTERN DIGITAL	WD1003A-SCS	SCSI-ST412(MFM)	NONE		2HD							DOES NOT PLUG INTO ISA BUS
WESTERN DIGITAL	WD1003A-WA2	ISA-ST412(MFM)	AT	3:1	2HD 2FD	2048 16			FULL XT			
WESTERN DIGITAL	WD1003S-RA2	ISA-ST412(RLL)	AT	2:1	2HD 2FD				3/4			
WESTERN DIGITAL	WD1003S-RAH	ISA-ST412(RLL)	AT	2:1	2HD				3/4			SETTINGS INCLUDED FOR COMPAQ
WESTERN DIGITAL	WD1003S-WA2	ISA-ST412(MFM)	AT	2:1	2HD 2FD				3/4			
WESTERN DIGITAL	WD1003S-WAH	ISA-ST412(MFM)	AT	2:1	2HD				3/4			SETTINGS INCLUDED FOR COMPAQ
WESTERN DIGITAL	WD1003V-MM1	ISA-ST412(MFM)	AT	2:1	2HD	1024 16	32		3/4 XT			OPTIONAL 2KB TRACK BUFFER
WESTERN DIGITAL	WD1003V-MM2	ISA-ST412(MFM)	AT	2:1	2HD 2FD	1024 16	32		3/4 XT			OPTIONAL 2KB TRACK BUFFER
WESTERN DIGITAL	WD1003V-SR1	ISA-ST412(RLL)	AT	2:1	2HD	2048 16	56	*	3/4 XT			OPTIONAL 2KB TRACK BUFFER
WESTERN DIGITAL	WD1003V-SR2	ISA-ST412(RLL)	AT	2:1	2HD 2FD	2048 16	56	*	3/4 XT			OPTIONAL 2KB TRACK BUFFER
WESTERN DIGITAL	WD1004-27X	ISA-ST412(RLL)	XT,AT	4:1	2HD	1024 16	56	B C	1/2 XT			POWER CONNECTOR ON BOARD
WESTERN DIGITAL	WD1004A-27X	ISA-ST412(RLL)	PC,XT	4:1	2HD	1024 16	56	B	1/2 XT			
WESTERN DIGITAL	WD1004A-WX1	ISA-ST412(MFM)	PC,XT	3:1	2HD	1024 16		B C	1/2 XT			POWER CONNECTOR ON BOARD
WESTERN DIGITAL	WD1005-WAH	ISA-ESDI	AT	2:1	2HD						XT	

MANUFACTURER	MODEL NUMBER	INTERFACES	BUS SUPPORT	INTER LEAVE	--MAX-- HDS FDS	---MAX--- CYLS HDS	ECC LGN.	B C	--SIZE-- LGN. HGT.	-CONTROLLER FLOPPY	IC-- HARD	ADDITIONAL COMMENTS
WESTERN DIGITAL	WD1006-RA2	ISA-ST412(RLL)	AT	1:1	2HD 2FD				XT			
WESTERN DIGITAL	WD1006-RAH	ISA-ST412(RLL)	AT	1:1	2HD	2048 16		*	XT			SETTINGS FOR COMPAQ, *OPTIONAL
WESTERN DIGITAL	WD1006-WA2	ISA-ST412(MFM)	AT	1:1	2HD 2FD				XT			
WESTERN DIGITAL	WD1006-WAH	ISA-ST412(MFM)	AT	1:1	2HD	2048 16			XT			SETTINGS INCLUDED FOR COMPAQ
WESTERN DIGITAL	WD1006V-MC1	MCA-ST412(MFM)	MCA	1:1	2HD	2048 16	32	B	FULL MC			8 or 32KB CACHE
WESTERN DIGITAL	WD1006V-MCR	MCA-ST412(RLL)	MCA	1:1	2HD	2048 16	56	B	FULL MC			
WESTERN DIGITAL	WD1006V-MM1	ISA-ST412(MFM)	AT	1:1	2HD	2048 16			3/4 XT			CACHE
WESTERN DIGITAL	WD1006V-MM2	ISA-ST412(MFM)	AT	1:1	2HD 2FD	2048 16			3/4 XT			CACHE
WESTERN DIGITAL	WD1006V-SR1	ISA-ST412(RLL)	AT	1:1	2HD	2048 16		*	3/4 XT			CACHE, *BIOS OPTION
WESTERN DIGITAL	WD1006V-SR2	ISA-ST412(RLL)	AT	1:1	2HD 2FD	2048 16		*	3/4 XT			CACHE, *BIOS OPTION
WESTERN DIGITAL	WD1007-WA2	ISA-ESDI	AT	1:1	2HD 2FD				3/4			
WESTERN DIGITAL	WD1007-WAH	ISA-ESDI	AT	1:1	2HD				3/4			
WESTERN DIGITAL	WD1007A-WA2	ISA-ESDI	AT	1:1	2HD 2FD			*	3/4 XT			*BIOS OPTION, 10Mb/sec.
WESTERN DIGITAL	WD1007A-WA4	ISA-ESDI	AT	1:1	2HD 2FD			*	XT			*BIOS OPT, CACHE, 1-S,1-P PORT
WESTERN DIGITAL	WD1007A-WAH	ISA-ESDI	AT	1:1	2HD			*	3/4 XT			*BIOS OPTION, 10Mb/sec.
WESTERN DIGITAL	WD1007A-WAH2	ISA-ESDI	AT	1:1	2HD 2FD			*	XT			*BIOS OPTION, 10Mb/sec.
WESTERN DIGITAL	WD1007V-MC1	MCA-ESDI	MCA	1:1	2HD				FULL MC			32KB CACHE
WESTERN DIGITAL	WD1007V-SE1	ISA-ESDI	AT	1:1	2HD		56	*	3/4 XT			32KB CACHE, *OPTIONAL
WESTERN DIGITAL	WD1007V-SE2	ISA-ESDI	AT	1:1	2HD 2FD		56	*	3/4 XT			32KB CACHE, *OPTIONAL
WESTERN DIGITAL	WD1009V-MM1	ISA-ESDI	AT	1:1	2HD	2048 16		*	FULL XT			64KB CACHE, *OPTIONAL, 20Mbs
WESTERN DIGITAL	WD1009V-MM2	ISA-ESDI	AT	1:1	2HD 2FD	2048 16		*	FULL XT			64KB CACHE, *OPTIONAL, 20Mbs
WESTERN DIGITAL	WD7000-AX,ASC	ISA-SCSI	AT	1:1	7HD 2FD			B C	FULL AT	WD 37C65B	WD 33C93A	(BUS MASTER) OEM MODEL
WESTERN DIGITAL	WD7000-FASST2	ISA-SCSI	AT	1:1	7HD 2FD			B C	FULL AT	WD 37C65B	WD 33C93A	(BUS MASTER) INCs SOFTWARE
WESTERN DIGITAL	WD7000EX-FASST	EISA-SCSI	EISA	1:1	7HD						WD 33C93B	(BUS MASTER)
WESTERN DIGITAL	WD7000MX-FASST	MCA-SCSI	MCA	1:1	7HD				FULL MC		WD 33C93B	(BUS MASTER)
WESTERN DIGITAL	WDAT140R	ISA-IDE(AT)	AT		2HD							
WESTERN DIGITAL	WDAT240R	ISA-IDE(AT)	AT		2HD 2FD							
WESTERN DIGITAL	WDAT440R	ISA-IDE(AT)	AT		2HD 2FD							1-SERIAL, 1-PARALLEL PORT
WESTERN DIGITAL	WDATXT-FASST	ISA-SCSI	XT,AT		7HD			B C	1/2 XT			(PIO, DMA, & BLIND I/O)
WESTERN DIGITAL	WDSPEEDK1T	ISA-ST412(MFM)	AT	1:1	2HD 2FD				3/4 XT			CACHE
WESTERN DIGITAL	WDXT-GEN	ISA-ST412(MFM)	PC,XT		2HD	1024 8		B	1/2 XT			NO JUMPERS

MANUFACTURER	MODEL NUMBER	INTERFACES	BUS SUPPORT	INTER LEAVE	--MAX-- HDs	---MAX--- CYLs	HDS	ECC LGN.	B C	--SIZE-- LGN. HGT.	-CONTROLLER FLOPPY	IC-- HARD	ADDITIONAL COMMENTS
WESTERN DIGITAL	WDXT-GEN2	ISA-ST412(MFM)	XT,AT		2HD	1024	8		B	1/2	XT		
WESTERN DIGITAL	WDXT140R	ISA-IDE(XT)	XT		1HD						XT		
WESTERN DIGITAL	WDXT150R	ISA-IDE(XT)	XT		1HD						XT		POWER CONNECTOR ON BOARD
WINCHESTER SYS.	FLASHSERVER	EISA-SCSI-2	EISA		14H				B C	FULL	AT		4-32MB CACHE, TWIN PROCESSORS
XEBEC	S1210	ISA-ST412(MFM)	PC,XT		2HD								FOR IBM PC
XEBEC	S1410	SCSI-ST412(MFM)	SCSI		2HD								
XEBEC	S1412	ISA-ST412(MFM)	PC,XT		2HD	2FD							
XEBEC	S1421	ISA-ST412(MFM)											

DRIVE CONTROLLER ABBREVIATIONS	THEREF43
HDS ..... HARD DRIVES	B ..... BIOS ON BOARD
FDS ..... FLOPPY DRIVES	C ..... CORESIDENT OK
CYLs ..... MAX. CYLINDER SUPPORTED	LGN ..... CARD LENGTH
HDS ..... MAX. HEADS SUPPORTED	HGT ..... CARD HEIGHT
ECC LGN .. # OF BITS IN ERROR CORRECTION CODE UTILIZED	
Copyright 1989,1993 F.Robert Falbo, all rights reserved.	
The User is granted permission to distribute this Listing and it's related documentation provided that it is not altered as to content or credit, and it is provided without purpose of monetary gain.	
<p style="text-align: center;">«« DISCLAIMER »»</p> <p>I have strived to make this Listing as accurate as I can, but I realize that mistakes do happen, and so should you. You should consider this Listing as a starting point. I suggest that you use the Manufacturer's Directory to obtain additional information directly before you finalize any decision.</p> <p>My liability shall be limited to only my embarrasment and an appology for any inconvenience caused.</p>	
I may be reached on KADET PCBoard BBS (315)245-3815 (USA). You may also try the Metrolink/Rime "Hardware" & "Harddisk" conferences, or the FidoNet "HDConf" & "OS2HW" conferences.	
PLEASE DO NOT REQUEST TheRef(tm) ON DISK FROM ME!	
If you know the specs for a hard disk, floppy disk, optical, or controller that's not listed, or have some information you feel should be in the DOC file, send it to me at the address below, and if I include it, you'll get listed in the "Credits" page as a Contributor. (Wow!...International Recognition!) <g>	
Mail all correspondence to:	F. Robert Falbo (THEREF43) 38 Northwinds Manor Rome, NY USA 13440-7314

# Floppy Drive Specs

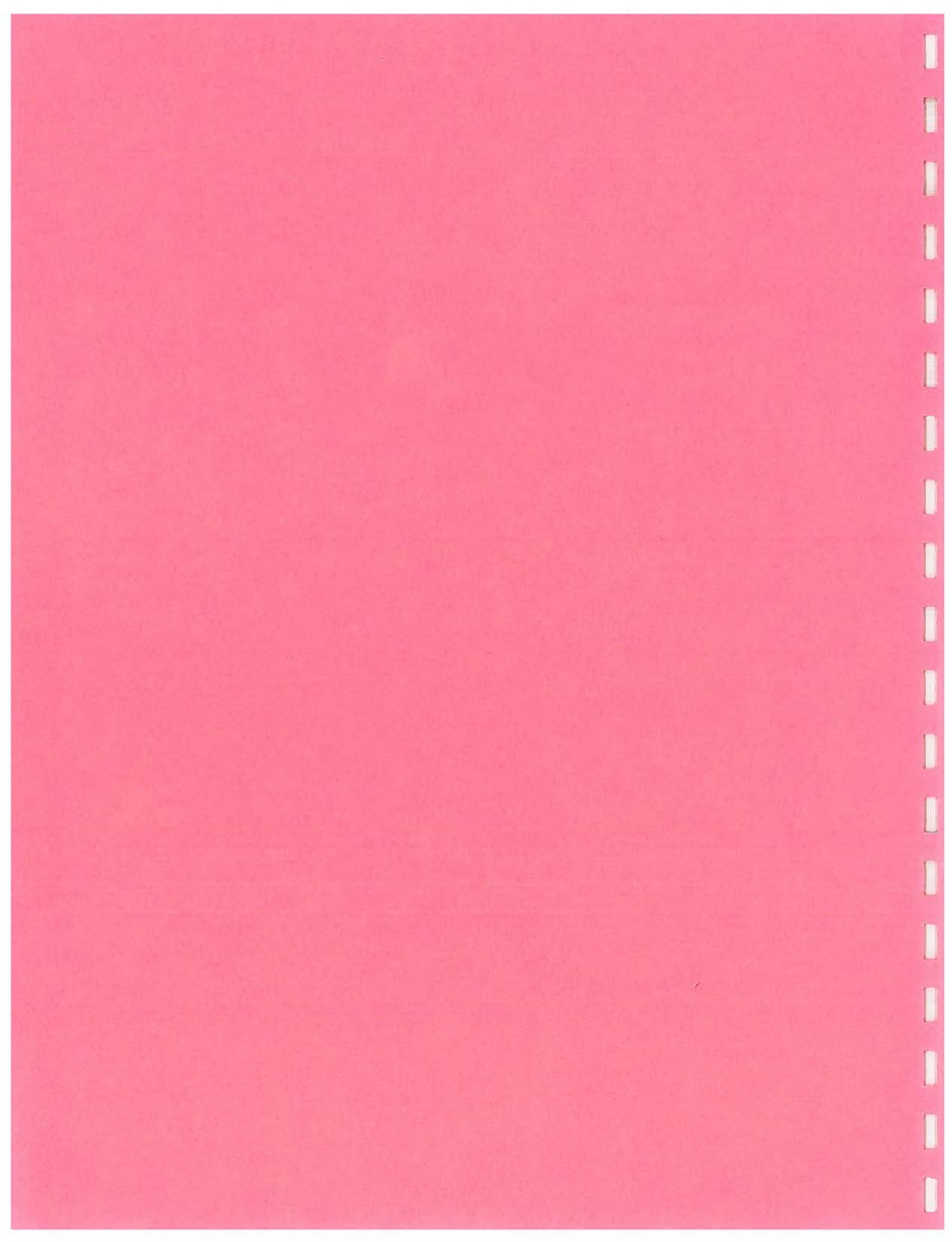



FLOPPY DRIVE DIRECTORY

THEREF(tm) Version 4.30

05/01/93

MANUFACTURER	MODEL NO.	SIZE		CAPACITY		DISK RPM	XFER RATE	TIMING		TRKs /IN.	TOTAL		SECT /TRK	POWER		MTBF (HRS)	WEIGHT	ADDITIONAL COMMENTS	PAGE 1
		WDTH.	HGT.	UNFMT'D	FORMT'D			ACC.	LATN.		CYLs	TRKs		+12v	+5v				
ALPS ELEC.	FDD2124	5.25	HALF	250KB	180KB	300													
AT&T	KS-23114	5.25	HALF	1.0MB	720KB					96	80								
AURORA TECH.	FD350 (SCSI)	3.50	HALF															R/O FOR SPARCSTATION	
AURORA TECH.	FD525 (SCSI)	5.25	HALF															R/O FOR SPARCSTATION	
CANNON	531	5.25	HALF	500KB	360KB	300													
CDC	9409	5.25	FULL	500KB	360KB	300													
CDC	9409T	5.25	FULL	1.0MB	720KB														
CDC	9429	5.25	HALF	1.0MB	720KB														
CHINON	FJ205	2.00		2.0MB	1.6MB														
CHINON	C354	3.50	HALF	1.0MB	720KB														
CHINON	C359	3.50	HALF	2.0MB	1.44MB														
CHINON	C502	5.25	HALF	500KB	360KB														
CHINON	C506	5.25	HALF	1.6MB	1.20MB														
EPSON	SMD-1040-xxx	3.50	17.8	2.0MB	1.44MB	300	500Kb			135	80	160	18	NONE	0.3A	15K	400g	xxx=COLOR	
EPSON	SMD-1060-xxx	3.50	17.8	4.0MB	2.88MB	300	1000Kb			135	80	160	36	NONE	0.3A	15K	400g	xxx=COLOR	
EPSON	SMD-340-xxx	3.50	25.4	2.0MB	1.44MB	300	500Kb			135	80	160	18	NONE	0.3A	10K	400g	xxx=COLOR	
EPSON	SMD-349-xxx	3.50	HALF	2.0MB	1.44MB	300	500Kb			135	80	160	18	NONE	0.3A	10K	400g	xxx=COLOR	
EPSON	SMD-380-xxx	3.50	25.4	1.0MB	720KB	300	250Kb			135	80	160	9	NONE	0.3A	10K	400g	xxx=COLOR	
EPSON	SMD-389-xxx	3.50	HALF	1.0MB	720KB	300	250Kb			135	80	160	9	NONE	0.3A	10K	400g	xxx=COLOR	
EPSON	SD-520	5.25	HALF	500KB	360KB	300													
EPSON	SD-521	5.25	HALF	500KB	360KB	300													
EPSON	SD-621L-xxx	5.25	HALF	500KB	360KB	300	250Kb	97ms	100ms	48	40	80		0.3A	0.3A	10K	1100g	xxx=COLOR	
EPSON	SD-680L-xxx	5.25	HALF	1.6MB	1.20MB	DUAL	500Kb	93ms	83ms	96	177	154		0.3A	0.3A	10K	1200g	xxx=COLOR,DUAL SPEED	
EPSON	SD-780	5.25	25.4	1.6MB	1.20MB	300	500Kb		83ms	96									
FUJITSU	M2551A	3.50		1.0MB	720KB	300													
FUJITSU	M2553A,K	3.50		2.0MB	1.44MB	300													
FUJITSU	M2552A	5.25	HALF	1.0MB	720KB					96	80								
INSITE	I325VM	3.50	25.4	25.0MB	20.8MB	720	1600Kb	65ms		1250	755	1510						FLOPTICAL SCSI	
MICRO SOLUTI	BACKPACK(3H)	3.50	HALF	4.0MB	2.88MB	300	1000Kb											EXT,R/W ALL, P-PORT	
MICRO SOLUTI	BACKPACK(3L)	3.50	HALF	2.0MB	1.44MB	300	500Kb											EXT, CONN TO P-PORT	



MANUFACTURER	MODEL NO.	SIZE		CAPACITY		DISK RPM	XFER RATE	TIMING		TRKs /IN.	TOTAL		SECT /TRK	POWER		MTBF (HRS)	WEIGHT	ADDITIONAL	PAGE 3 COMMENTS
		WDTH.	HGT.	UNFMT'D	FORMT'D			ACC.	LATN.		CYLS	TRKS		+12v	+5v				
SANYO	FDA-5200	5.25	HALF	500KB	360KB	300													
SEIKO	8640	5.25	FULL	1.0MB	720KB					96	80								
SHUGART	SA400L	5.25	FULL	250KB	180KB	300													
SHUGART	SA455	5.25	HALF	500KB	360KB	300													
SHUGART	SA460	5.25	FULL	500KB	360KB	300													
SHUGART	SA800-1	8.00	FULL																SINGLE SIDED
SHUGART	SA800-2	8.00	FULL																SINGLE SIDED
SHUGART	SA860	8.00	HALF																
SHUGART	SA900-1	8.00	FULL																SINGLE SIDED
SIEMENS	FDD100-5	5.25	FULL	250KB	180KB	300													
SONY	MP-F11W	3.50	25.4	1.0MB	720KB		250Kb	94ms											30K
SONY	MP-F17W	3.50	25.4	2.0MB	1.44MB		500Kb	94ms											30K
SONY	MP-F40W	3.50	25.4	4.0MB	2.88MB		1000Kb	94ms											30K
TANDON	65-4	5.25	HALF	1.0MB	720KB														
TANDON	65-8	5.25	HALF	1.6MB	1.20MB														
TANDON	TM100-1A	5.25	FULL	250KB	180KB	300													
TANDON	TM100-2A	5.25	FULL	500KB	360KB	300													
TANDON	TM100-4	5.25	FULL	1.0MB	720KB														
TANDON	TM101-4A	5.25	FULL	1.0MB	720KB														
TANDON	848-02	8.00	HALF																
TEAC	FD-05	3.50	12.7	2.0MB	1.44MB	300	500Kb			135	80	160	18						VERY LOW HEIGHT
TEAC	FD-235F	3.50	25.4	1.0MB	720KB	300	250Kb	94ms	100ms	135	80	160	9	NONE	0.3A	20K	400g		
TEAC	FD-235HF	3.50	25.4	2.0MB	1.44MB	300	500Kb	94ms	100ms	135	80	160	18	NONE	0.3A	20K	400g		
TEAC	FD-235HS	3.50	25.4	2.0MB	1.44MB	300	500Kb	94ms	100ms	135	80	160	18	NONE	0.3A	20K	400g		SCSI INTERFACE
TEAC	FD-235J	3.50	25.4	4.0MB	2.88MB	300	1000Kb	94ms	100ms	135	80	160	36	NONE	0.3A	20K	400g		VERT.REC.,READS REG.
TEAC	FD-235JS	3.50	25.4	4.0MB	2.88MB	300	1000Kb	94ms	100ms	135	80	160	36	NONE	0.3A	20K	400g		SCSI INTERFACE
TEAC	FD-335F	3.50	19.0	1.0MB	720KB	300	250Kb	94ms	100ms	135	80	160	9	NONE	0.3A	20K	300g		
TEAC	FD-335HF	3.50	19.0	2.0MB	1.44MB	300	500Kb	94ms	100ms	135	80	160	18	NONE	0.3A	20K	300g		
TEAC	FD-335HS	3.50	19.0	2.0MB	1.44MB	300	500Kb	94ms	100ms	135	80	160	18	NONE	0.3A	20K	300g		SCSI INTERFACE
TEAC	FD-335J	3.50	19.0	4.0MB	2.88MB	300	1000Kb	94ms	100ms	135	80	160	36	NONE	0.3A	20K	300g		VERT.REC.,READS REG.
TEAC	FD-335JS	3.50	19.0	4.0MB	2.88MB	300	1000Kb	94ms	100ms	135	80	160	36	NONE	0.3A	20K	300g		VERT/READS REG,SCSI
TEAC	FD-155	5.25	25.4	1.6MB	1.20MB		500Kb			96	80	160	15						VERY LOW HEIGHT

MANUFACTURER	MODEL NO.	SIZE		CAPACITY		DISK RPM	XFER RATE	TIMING		TRKS /IN.	TOTAL		SECT /TRK	POWER		MTBF (HRS)	WEIGHT	ADDITIONAL COMMENTS	PAGE 4
		WDTH.	HGT.	UNFMT'D	FORMT'D			ACC.	LATN.		CYLs	TRKs		+12v	+5v				
TEAC	FD-50A	5.25	FULL	250KB	180KB	300													
TEAC	FD-505	5.25	HALF																1.2/1.44 COMBO UNIT
TEAC	FD-55A	5.25	HALF	250KB	180KB	300	250Kb	93ms	100ms	48	40	40	16	0.3A	0.4A	10K	1500g	SINGLE SIDED	
TEAC	FD-55BR	5.25	HALF	500K	360KB	300	250Kb	93ms	100ms	48	40	80	16	0.3A	0.4A	20K	1500g		
TEAC	FD-55E	5.25	HALF	500KB	360KB	300	250Kb	93ms	100ms	96	80	80	16	0.3A	0.4A	10K	1500g	SINGLE SIDED	
TEAC	FD-55FV	5.25	HALF	1.0MB	720KB	300	250Kb	93ms	100ms	96	80	160	16	0.3A	0.4A	10K	1500g		
TEAC	FD-55GFR	5.25	HALF	1.6MB	1.20MB	DUAL	500Kb	91ms	83ms	96	80	160	15	0.3A	0.4A	20K	1500g	DUAL SPEED	
TEAC	FD-55GR	5.25	HALF	1.6MB	1.20MB	360	500Kb	91ms	83ms	96	77	154	15	0.3A	0.4A	10K	1500g		
TEAC	FD-55GS	5.25	HALF	1.6MB	1.20MB	DUAL	500Kb	91ms	83ms	96	80	160	15	0.3A	0.4A	20K	1500g	DUAL SPEED, SCSI	
TEC	FB501	5.25	HALF	250KB	180KB	300													
TOSHIBA	ND-352T,S	3.50	25.4	1.0MB	720KB	300	250Kb	79ms	100ms	135	80	160	9	N/A		10K	400g		
TOSHIBA	ND-354A	3.50	25.4	1.0MB	720KB	300	250Kb	79ms	100ms	135	80	160	9	N/A		10K	400g		
TOSHIBA	ND-356T,Y,S	3.50	25.4	2.0MB	1.44MB	300	500Kb	79ms	100ms	135	80	160	18	N/A		10K	400g		
TOSHIBA	PD-211	3.50	25.4	4.0MB	2.88MB		1000Kb	94ms										VERT.REC.,READS REG.	
TOSHIBA	ND-04D	5.25	HALF	500KB	360KB	300	250Kb	78ms	100ms	48	40	80	8			12K	1400g		
TOSHIBA	ND-08DEG	5.25	HALF	1.6MB	1.20MB	DUAL	500Kb	76ms	83ms	96	77	154	15			12K	1400g	DUAL SPEED	

## FLOPPY DRIVE ABBREVIATIONS

THEREF43

XFER ... TRANSFER RATE	ACC .... AVERAGE ACCESS TIME
TRKS/IN. TRACKS PER INCH	LATN ... HEAD/ARM LATENCY
RPM .... REVS PER MINUTE	WGT .... WEIGHT OF DRIVE
CYLs ... TOTAL CYLINDERS	MTBF ... MEAN TIME BEFORE
TRKS ... TRACKS	FAILURE (ESTIMATED)

Copyright 1990,1993 F.Robert Falbo, all rights reserved.

The User is granted permission to distribute this Listing and it's related documentation provided that it is not altered as to content or credit, and it is provided without purpose of monetary gain.

«« DISCLAIMER »»

I have strived to make this Listing as accurate as I can, but I realize that mistakes do happen, and so should you. You should consider this Listing as a starting point. I suggest that you use the Manufacturer's Directory to obtain additional information directly before you finalize any decision.

My liability shall be limited to only my embarrassment and an appology for any inconvenience caused.

I may be reached on KADET PCBoard BBS (315)245-3815 (USA). You may also try the Metrolink/Rime "Hardware" & "Harddisk" conferences, or the FidoNet "HDConf" & "OS2HW" conferences.

PLEASE DO NOT REQUEST TheRef(tm) ON DISK FROM ME!

If you know the specs for a hard disk, floppy disk, optical or controller that's not listed, or have some information you feel should be in the DOC file, send it to me at the address below, and if I include it, you'll get listed in the "Credits" page as a Contributor. (Wow!...International Recognition!) <g>

Mail all correspondence to: F. Robert Falbo  
(THEREF43)  
38 Northwinds Manor  
Rome, NY USA 13440-7314

Handwritten text, possibly bleed-through from the reverse side of the page. The text is extremely faint and illegible.

# Hard Drive Specs

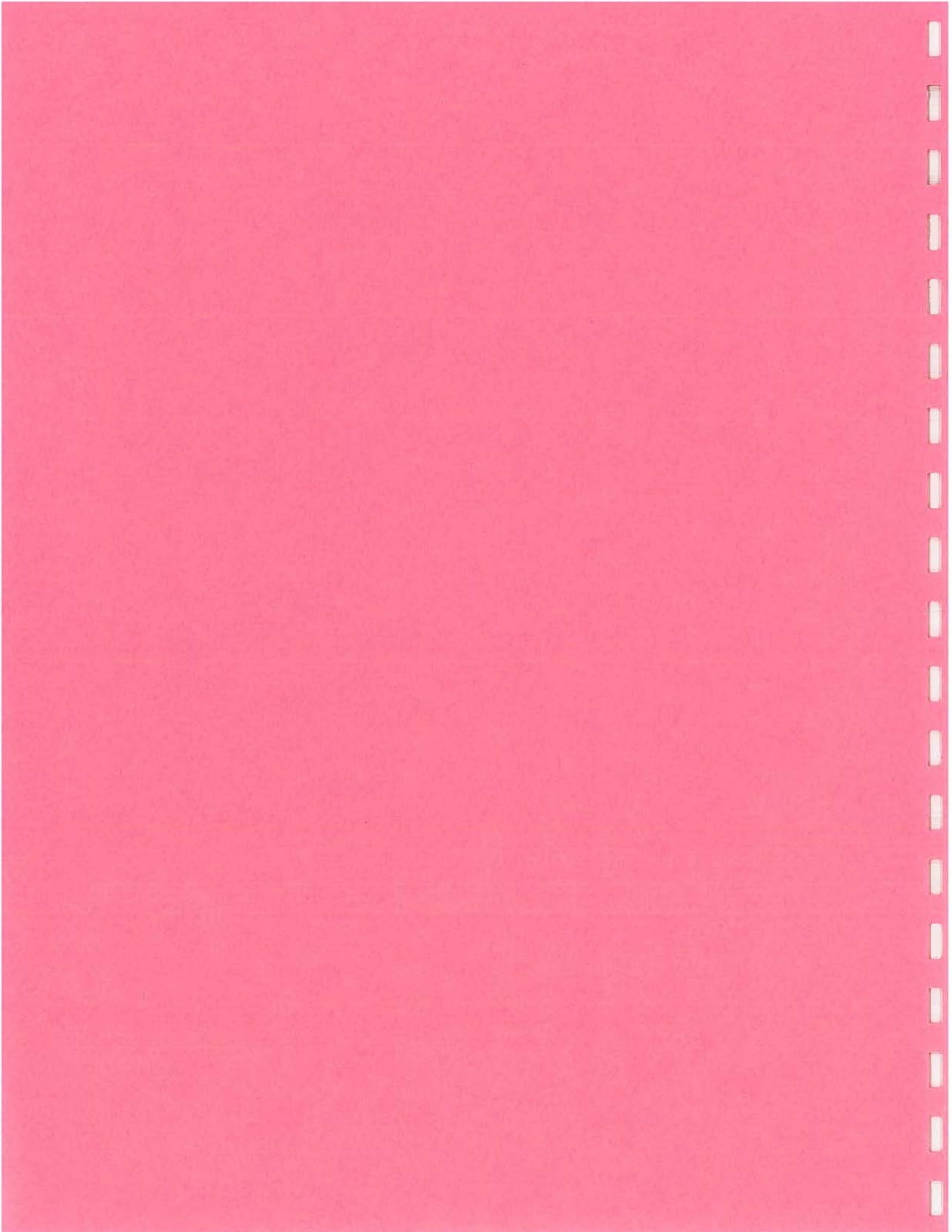



HARD DISK DRIVE DIRECTORY

THEREF(tm) Version 4.30

05/01/93

MODEL NUMBER	--SIZE--		-----CAPACITY-----		-----PHYSICAL-----					-LOGICAL-				TKS /IN.	--ACCESS--		XFER RATE	CACHE	MTBF	POWER USED	COMMENTS
	WTH.	HGT.	UNFORMAT	FORMATED	CYLS	PRE-COMP	LAND ZONE	S/ #	RW HD	INTER-FACE	CYLS	S/ RW	TK HD		RECORD METHOD	AVE. TK/TK					
ALPS ELEC.																					
DRND-10A	3.50	HALF	10.0MB	615			17	1	2	ST506/412			(1,3)RLL	60ms	5.0Mb						
DRND-20A	3.50	HALF	20.0MB	615			17	2	4	ST506/412			(1,3)RLL	60ms	5.0Mb						
DRPO-20D	3.50	HALF	20.0MB	615			26	1	2	ST506/412			(2,7)RLL	60ms	7.5Mb						
RPO-20A	3.50	HALF	20.0MB	615			26	1	2	ST506/412			(2,7)RLL	60ms	7.5Mb						
AMPEX																					
PYXIS-13	5.25	FULL	13.0MB	10.0MB	320	132	17	2	4	ST506/412			(1,3)RLL	90ms	5.0Mb						
PYXIS-20	5.25	FULL	20.0MB	15.0MB	320	132	17	3	6	ST506/412			(1,3)RLL	90ms	5.0Mb						
PYXIS-27	5.25	FULL	27.0MB	20.0MB	320	132	17	4	8	ST506/412			(1,3)RLL	90ms	5.0Mb						
PYXIS-7	5.25	FULL	7.0MB	5.0MB	320	132	17	1	2	ST506/412			(1,3)RLL	90ms	5.0Mb						
AREAL TECH.																					
A-120	2.50	15.5	136.9MB	1070	NONE	AUTO	63	2	4	VC IDE(X/A)			(1,7)RLL	2760	15ms	3.0ms	15.0Mb	100K	1.5W	GLASS PLATTERS, 2,981 RPM	
A-130	2.50	12.4	130.0MB	1453	NONE	AUTO	MZ	1	2	VC IDE(AT)			(1,7)RLL	2763	15ms	3.0ms	23.0Mb	100K	1.5W	GLASS PLATTERS, 2,981 RPM	
A-180	2.50	15.5	183.0MB	1430	NONE	AUTO	63	2	4	VC IDE(X/A)			(1,7)RLL	2760	15ms	3.0ms	15.0Mb	100K	1.5W	GLASS PLATTERS, 2,981 RPM	
A-260	2.50	15.0	260.1MB	1453	NONE	AUTO	MZ	2	4	VC IDE(AT)			(1,7)RLL	2763	15ms	3.0ms	23.0Mb	100K	1.5W	GLASS PLATTERS, 2,981 RPM	
A-90	2.50	12.4	91.5MB	1430	NONE	AUTO	63	1	2	VC IDE(X/A)			(1,7)RLL	2762	15ms	3.0ms	15.0Mb	100K	1.5W	GLASS PLATTERS	
BP-100	2.50	SUBH	100.0MB		NONE	AUTO		1		VC SCSI			(2,7)RLL								
MD-2050	2.50	SUBH	49.2MB	819	NONE	AUTO		1		VC			(2,7)RLL	28ms	7.5Mb			.9W			
MD-2060	2.50	15.0	62.4MB	1024	NONE	AUTO	60	1	2	VC IDE(X/A)			(2,7)RLL	2005	19ms	4.0ms	10.0Mb	32KB	100K	1.8W	GLASS PLATTERS, 2,087 RPM
MD-2065	2.50	15.0	62.4MB	1024	NONE	AUTO	60	1	2	VC IDE(X/A)			RLL	2703	16ms	4.0ms	12.0Mb	100K	1.8W	GLASS PLATTERS, 2,504 RPM	
MD-2080	2.50	15.0	80.8MB	1326	NONE	AUTO	60	1	2	VC IDE(X/A)			(2,7)RLL	2630	19ms	4.0ms	10.0Mb	100K	1.8W	GLASS PLATTERS, 2,087 RPM	
MD-2085	2.50	15.0	85.9MB	1410	NONE	AUTO	60	1	2	VC IDE(X/A)			RLL	2703	16ms	4.0ms	12.0Mb	100K	1.8W	GLASS PLATTERS, 2,504 RPM	
MD-2100	2.50	SUBH	100.0MB		NONE	AUTO				VC			(2,7)RLL	29ms	7.5Mb			0.9W			
AA-5180 SYSTEM	5.25	FULL	720.0MB		NONE	AUTO		10	20	VC SCSI-2			(1,7)RLL		32.0Mb					GLASS PLATTERS, 2,981 PRM	
AA-9180 SYSTEM	5.25	FULL	1440.0MB		NONE	AUTO		18	36	VC SCSI-2			(1,7)RLL		64.0Mb					GLASS PLATTERS, 2,981 PRM	
ATASI																					
3020	5.25	FULL	20.0MB	17.0MB	645	320	17	2	3	ST506/412			(1,3)RLL		5.0Mb						
3033	5.25	FULL	33.0MB	28.0MB	645	320	17	3	5	ST506/412			(1,3)RLL		5.0Mb						
3046	5.25	FULL	46.0MB	39.0MB	645	320	644	17	4	7	ST506/412			(1,3)RLL	33ms	5.0Mb					

MODEL NUMBER	--SIZE--		-----CAPACITY-----		-----PHYSICAL-----					--LOGICAL--			TKS /IN.	--ACCESS--		XFER RATE	CACHE	MTBF	POWER USED	COMMENTS	
	WTH.	HGT.	UNFORMAT	FORMATED	PRE-CYLS	LAND COMP	S/ZONE	# PL	RW HD AC	INTER-FACE	S/ CYLS	RW TK		HD	RECORD METHOD						AVE. TK/TK
3051	5.25	FULL	51.0MB	43.0MB	704	350		17 4 7	ST506/412				(1,3)RLL	33ms	5.0Mb						
3053	5.25	FULL	53.0MB	44.0MB	733			17 4 7	ST506/412				(1,3)RLL		5.0Mb						
3075	5.25	FULL	75.0MB	67.0MB	1024			17 4 8	ST506/412				(1,3)RLL		5.0Mb						
3085	5.25	FULL	85.0MB	72.0MB	1024			17 4 8	ST506/412				(1,3)RLL		5.0Mb						
6120	5.25	FULL		1051.0MB	1925			AUTO 71 8 15	VC ESDI				(2,7)RLL	14ms	20.0Mb		150K	24.0W			
676	5.25	FULL		765.0MB	1632			AUTO 54 8 15	VC ESDI				(2,7)RLL	16ms	15.0Mb		150K	31.0W			
738	5.25	FULL		329.0MB	1225				8 15 VC SCSI				(2,7)RLL	20ms	10.0Mb						
ATTO TECHNOLOGY																					
SiliconDisk Plu				512.0MB					SCSI-2				NONE	.1ms	80.0Mb					SOLID STATE DISK,1,4,16MB SIMM	
SiliconDisk Pro				512.0MB					SCSI-2				NONE	.1ms	80.0Mb						SOLID STATE DISK,1,4,16MB SIMM
AURA ASSOCIATES																					
AU126	1.80	15.0		125.8MB					NONE AUTO 2 4 VC PCMCIA				(1,7)RLL	3200 17ms 5.0ms	24.0Mb	32KB	100K	1.5W		5,400 RPM	
AU43	1.80	12.7		42.6MB					NONE AUTO 1 2 VC IDE(AT)				(1,7)RLL	2550 17ms 5.0ms	24.0Mb	32KB	100K	1.5W		5,400 RPM	
AU63	1.80	12.7		62.9MB					NONE AUTO 1 2 VC PCMCIA				(1,7)RLL	3200 17ms 5.0ms	24.0Mb	32KB	100K	1.4W		5,400 RPM	
AU85	1.80	15.0		85.3MB					NONE AUTO 2 4 VC IDE(AT)				(1,7)RLL	2550 17ms 5.0ms	24.0Mb	32KB	100K	1.6W		5,400 RPM	
BASF																					
6185	5.25	FULL		23.0MB	440	220		17 3 6	ST506/412				(1,3)RLL		5.0Mb						
6186	5.25	FULL		15.0MB	440	220		17 2 4	ST506/412				(1,3)RLL		5.0Mb						
6187	5.25	FULL		8.0MB	440	220		17 1 2	ST506/412				(1,3)RLL		5.0Mb						
BULL																					
D-530			30.0MB	25.0MB	987			17 2 3	ST506/412				(1,3)RLL		5.0Mb						
D-550			50.0MB	43.0MB	987			17 3 5	ST506/412				(1,3)RLL		5.0Mb						
D-570			70.0MB	59.0MB	987			17 4 7	ST506/412				(1,3)RLL		5.0Mb						
D-585	5.25	FULL	85.0MB	71.0MB	1166			17 4 7	ST506/412				(1,3)RLL	65ms	5.0Mb						
C. ITOH & Co.																					
YD-3042	3.50	HALF		43.5MB	788			2 4	SCSI				(2,7)RLL	1104 28ms	8.5Mb		40K	12.0W			
YD-3082	3.50	HALF		83.0MB	788			3 5	SCSI				(2,7)RLL	1104 27ms	8.5Mb		40K	12.0W			
YD-3530	5.25	HALF		32.0MB	731			17 3 5	ST506/412				(1,3)RLL	26ms	5.0Mb						
YD-3540	5.25	HALF		45.0MB	731			17 4 7	ST506/412				(1,3)RLL	26ms	5.0Mb						
CARDIFF																					
F-3053	3.50	HALF	53.0MB	44.0MB	1024			17 3 5	ST506/412				(1,3)RLL	20ms	5.0Mb						

MODEL NUMBER	--SIZE--		-----CAPACITY-----		-----PHYSICAL-----					-LOGICAL-			RECORD METHOD	TKS /IN.	--ACCESS--		XFER RATE	CACHE	MTBF	POWER USED	COMMENTS
	WTH.	HGT.	UNFORMAT	FORMATED	CYLS	PRE-COMP	LAND ZONE	S/ #	RW HD AC	INTER-FACE	CYLS	TK			HD	AVE.					
F-3080E	3.50	HALF	80.0MB	68.0MB	1024			26 3 5	ESDI				(2,7)RLL	20ms		7.0Mb					
F-3080S	3.50	HALF	80.0MB	68.0MB	1024			26 3 5	SCSI				(2,7)RLL	20ms		7.5Mb					
F-3127E	3.50	HALF	127.0MB	109.0MB	1024			35 3 5	ESDI				(2,7)RLL	20ms		10.0Mb					
F-3127S	3.50	HALF	127.0MB	109.0MB	1024			35 3 5	SCSI				(2,7)RLL	20ms		10.0Mb					
CDC BJ7D5A																					
77731608	5.25	FULL		29.0MB	670	128		17 3 5	ST506/412				(1,3)RLL			5.0Mb					
77731613	5.25	FULL			733	128		17 3 5	ST506/412				(1,3)RLL			5.0Mb					
77731614	5.25	FULL		23.0MB	670			17 2 4	ST506/412				(1,3)RLL	36ms							
CDC ELITE																					
97500-12G	5.25	FULL	1200.0MB					10 17 VC	SMD					12ms		24.0Mb		100K	50.0W		
97501-15G	5.25	FULL	1500.0MB					MZ 10 17 VC	SCSI-2				RLL	12ms		30.0Mb		100K	45.0W		
97509-12G	5.25	FULL	1200.0MB					10 17 VC	IPI-2					12ms		24.0Mb		100K	50.0W		
CDC SWIFT																					
94311-136	3.50	SUBH	136.0MB	120.0MB				3 5 VC	SCSI				(2,7)RLL	15ms		10.0Mb		70K	9.0W		
94311-136	3.50	HALF	136.0MB	120.0MB				3 5 VC	SCSI				(2,7)RLL	15ms		10.0Mb		70K	9.0W		
94311-136S	3.50	SUBH	136.0MB	120.0MB				3 5 VC	SCSI-2				(2,7)RLL	15ms		10.0Mb		70K	9.0W		
94314-136	3.50	SUBH	136.0MB	120.0MB				3 5 VC	IDE(AT)				(2,7)RLL	15ms		10.0Mb		70K	9.0W		
94316-111	3.50	HALF	111.0MB	98.0MB	1072			3 5	ESDI					1543 23ms		10.0Mb		70K	11.0W		
94316-136	3.50	HALF	136.0MB	120.0MB				3 5 VC	ESDI				(2,7)RLL	15ms		10.0Mb		70K	11.0W		
94316-155	3.50	HALF	155.0MB	138.0MB	1072			4 7 VC	ESDI					1543 15ms		10.0Mb		70K	11.0W		
94316-200	3.50	HALF	200.0MB	177.0MB	1072			5 9 VC	ESDI					1543 15ms		10.0Mb		99K	11.0W		
94335-055	3.50	HALF	55.0MB	46.0MB				17 3 5 VC	ST506/412				(1,3)RLL	25ms		5.0Mb					
94335-100	3.50	HALF	100.0MB	83.0MB				17 5 9 VC	ST506/412				(1,3)RLL	25ms		5.0Mb					
94335-150	3.50	HALF	150.0MB	128.0MB				AUTO 26 5 9 VC	ST506/412				(2,7)RLL	25ms		7.5Mb					
94351-111	3.50	HALF	111.0MB	98.0MB	1068			3 5 VC	SCSI				(2,7)RLL	15ms		10.0Mb		70K	11.0W		
94351-126	3.50	HALF	126.0MB	111.0MB	1068			AUTO 36 4 7 VC	SCSI				(2,7)RLL	15ms		8.0Mb		70K	11.0W		
94351-128	3.50	HALF	128.0MB	111.0MB	1068			AUTO 36 4 7 VC	SCSI				(2,7)RLL	15ms		10.0Mb					
94351-133S	3.50	HALF	133.0MB	116.0MB	1268			AUTO 3 5 VC	SCSI-2				(2,7)RLL	15ms		10.0Mb		70K	11.0W		
94351-134	3.50	HALF	134.0MB		1068			AUTO 36 4 7 VC	SCSI				(2,7)RLL	15ms		10.0Mb					
94351-155	3.50	HALF	156.0MB	138.0MB	1068			AUTO 4 7 VC	SCSI				(2,7)RLL	15ms		10.0Mb					
94351-155S	3.50	HALF	156.0MB	138.0MB	1068			AUTO 4 7 VC	SCSI-2				(2,7)RLL	15ms		10.0Mb		70K	11.0W		

MODEL NUMBER	--SIZE--		-----CAPACITY----		-----PHYSICAL-----							-LOGICAL-		RECORD METHOD	TKS /IN.	--ACCESS--		XFER RATE	CACHE	MTBF	POWER USED	COMMENTS
	WTH.	HGT.	UNFORMAT	FORMATED	CYLS	PRE-COMP	LAND ZONE	S/TK	# PL	RW HD AC	INTER-FACE	CYLS	S/TK			RD HD	AVE.					
94351-160	3.50	HALF	162.0MB	142.0MB	1068		AUTO	36	5	9	VC	SCSI		(2,7)RLL	15ms	8.0Mb		70K	11.0W			
94351-172	3.50	HALF	172.0MB		1068		AUTO	36	5	9	VC	SCSI		(2,7)RLL	15ms	10.0Mb						
94351-186S	3.50	HALF	186.0MB	163.0MB	1268		AUTO		4	7	VC	SCSI-2		(2,7)RLL	15ms	10.0Mb		70K	11.0W			
94351-200	3.50	HALF	201.0MB	177.0MB	1068		AUTO	36	5	9	VC	SCSI		(2,7)RLL	15ms	10.0Mb		70K	11.0W			
94351-200S	3.50	HALF	201.0MB	177.0MB	1068		AUTO	36	5	9	VC	SCSI-2		(2,7)RLL	15ms	10.0Mb		70K	11.0W			
94351-230S	3.50	HALF	239.0MB	210.0MB	1273		AUTO	36	5	9	VC	SCSI-2		(2,7)RLL	15ms	10.0Mb		70K	11.0W			
94354-111	3.50	HALF	111.0MB	98.0MB	1072		AUTO		3	5	VC	IDE(AT)		(2,7)RLL	15ms	10.0Mb		70K	11.0W			
94354-126	3.50	HALF	126.0MB	111.0MB	1072		AUTO	29	4	7	VC	IDE(AT)		(2,7)RLL	15ms	8.0Mb		70K	11.0W			
94354-133	3.50	HALF	133.0MB	117.0MB	1272		AUTO	29	3	5	VC	IDE(AT)		(2,7)RLL	15ms	10.0Mb		70K	11.0W			
94354-155	3.50	HALF	156.0MB	138.0MB	1072		AUTO	29	4	7	VC	IDE(AT)		(2,7)RLL	15ms	10.0Mb		70K	11.0W			
94354-160	3.50	HALF	162.0MB	143.0MB	1072		AUTO	29	5	9	VC	IDE(AT)		(2,7)RLL	15ms	8.0Mb		70K	11.0W			
94354-186	3.50	HALF	186.0MB	164.0MB	1272		AUTO		4	7	VC	IDE(AT)		(2,7)RLL	15ms	10.0Mb		70K	11.0W			
94354-200	3.50	HALF	201.0MB	177.0MB	1072		AUTO	36	5	9	VC	IDE(AT)		(2,7)RLL	15ms	10.0Mb		70K	11.0W			
94354-230	3.50	HALF	239.0MB	211.0MB	1272		AUTO	36	5	9	VC	IDE(AT)		(2,7)RLL	15ms	10.0Mb		70K	11.0W			
94355-055	3.50	HALF	55.0MB	46.0MB					17	3	5	VC	ST506/412	(1,3)RLL	17ms	5.0Mb						
94355-100	3.50	HALF	100.0MB	88.0MB	1072		AUTO	17	5	9	VC	ST506/412	(1,3)RLL	1350	15ms	5.0Mb		70K	9.0W			
94355-150	3.50	HALF	150.0MB	133.0MB	1072		AUTO	28	5	9	VC	ST506/412	(2,7)RLL	1350	15ms	7.5Mb		70K	9.0W			
94356-111	3.50	HALF	111.0MB	98.0MB	1072		AUTO		3	5	VC	ESD1		(2,7)RLL	15ms	10.0Mb		70K	11.0W			
94356-155	3.50	HALF	156.0MB	138.0MB	1072		AUTO		4	7	VC	ESD1		(2,7)RLL	15ms	10.0Mb		70K	11.0W			
94356-200	3.50	HALF	201.0MB	177.0MB	1072		AUTO		5	9	VC	ESD1		(2,7)RLL	15ms	10.0Mb		70K	11.0W			
CDC WREN I																						
94155-021	5.25	FULL	21.0MB	18.2MB	697	NONE			17	2	3		ST506/412	(1,3)RLL	28ms	5.0Mb						
94155-025	5.25	FULL	28.0MB	24.3MB	697	NONE			17	2	4		ST506/412	(1,3)RLL	28ms	5.0Mb						
94155-028	5.25	FULL	28.0MB	24.3MB	697	NONE			17	2	4		ST506/412	(1,3)RLL	28ms	5.0Mb						
94155-036	5.25	FULL	36.0MB	30.3MB	697	NONE			17	3	5		ST506/412	(1,3)RLL	28ms	5.0Mb						
94155-038	5.25	FULL	38.0MB	31.0MB	733	NONE			17	3	5		ST506/412	(1,3)RLL	28ms	5.0Mb						
CDC WREN II																						
94151-025	5.25	FULL		25.5MB	921				36	2	3		SASI							94151-25/27:256B/SEC		
94151-027	5.25	FULL		27.2MB	921				19	2	3		SASI							94151-25/27:512B/SEC		
94151-042	5.25	FULL		42.4MB	921				36	3	5		SASI							94151-42/44:256B/SEC		
94151-044	5.25	FULL		44.8MB	921				19	3	5		SASI							94151-42/44:512B/SEC		

MODEL NUMBER	--SIZE--		-----CAPACITY-----		-----PHYSICAL-----						-LOGICAL-			RECORD METHOD	TKS /IN.	--ACCESS--		XFER RATE	CACHE	MTBF	POWER USED	COMMENTS
	WTH.	HGT.	UNFORMAT	FORMATED	CYLS	PRE-COMP	LAND ZONE	S/TK	#PL	RW/HD	HD/AC	INTER-FACE	CYLS			TK	HD					
94151-059	5.25	FULL		59.4MB	921			36	4	7	SASI										94151-59/62:256B/SEC	
94151-062	5.25	FULL		62.7MB	921			19	4	7	SASI										94151-59/62:512B/SEC	
94151-076	5.25	FULL		76.4MB	921			36	5	9	SASI										94151-76/80:256B/SEC	
94151-080	5.25	FULL		80.6MB	921			19	5	9	SASI										94151-76/80:512B/SEC	
94155-036	5.25	FULL	36.0MB	30.3MB	697	128		17		5	ST506/412		(1,3)	RLL				5.0Mb				
94155-037	5.25	FULL	37.0MB	32.0MB	925			17		4	ST506/412		(1,3)	RLL				5.0Mb				
94155-048	5.25	FULL	48.0MB	40.3MB	925	NONE	AUTO	17	3	5	VC ST506/412		(1,3)	RLL	28ms			5.0Mb				
94155-051	5.25	FULL	51.0MB	43.0MB	989			17	3	5	ST506/412		(1,3)	RLL	28ms			5.0Mb				
94155-057	5.25	FULL	57.0MB	48.3MB	925	NONE	926	17	3	6	ST506/412		(1,3)	RLL	28ms			5.0Mb				
94155-067	5.25	FULL	67.0MB	56.4MB	925	NONE	926	17	4	7	ST506/412		(1,3)	RLL	28ms			5.0Mb				
94155-077	5.25	FULL	77.0MB	64.4MB	925	NONE	926	17	4	8	ST506/412		(1,3)	RLL	28ms			5.0Mb				
94155-085	5.25	FULL	85.0MB	71.3MB	1024		AUTO	17	5	8	VC ST506/412		(1,3)	RLL	980	28ms		5.0Mb	40K	28.0W		
94155-086	5.25	FULL	86.0MB	72.5MB	925		AUTO	17	5	9	VC ST506/412		(1,3)	RLL	960	28ms		5.0Mb	40K	28.0W		
94155-096	5.25	FULL	96.0MB	80.2MB	1024		AUTO	17	5	9	VC ST506/412		(1,3)	RLL	980	28ms		5.0Mb	40K	28.0W		
94155-120	5.25	FULL	120.0MB	102.2MB	960	NONE	961	26		8	ST506/412		(2,7)	RLL				7.5Mb				
94155-130	5.25	FULL	130.0MB	122.7MB	1024	128	AUTO	26	5	9	VC ST506/412		(2,7)	RLL								
94155-135	5.25	FULL	135.0MB	115.0MB	960		AUTO	26	5	9	VC ST506/412		(2,7)	RLL	980	28ms		7.5Mb	40K	28.0W		
94156-048	5.25	FULL	48.0MB	40.3MB	925	NONE	AUTO	17	3	5	VC ESDI		(2,7)	RLL	28ms			5.0Mb				
94156-067	5.25	FULL	67.0MB	56.4MB	925	NONE	AUTO	17	4	7	VC ESDI		(2,7)	RLL				10.0Mb				
94156-086	5.25	FULL	86.0MB	72.5MB	925	NONE	AUTO	17	5	9	VC ESDI		(2,7)	RLL				10.0Mb				
94204-074	5.25	HALF	74.0MB	65.5MB	941		AUTO	3	5	VC	IDE(AT)		(2,7)	RLL	28ms			7.5Mb	40K	20.0W		
94204-081	5.25	HALF	81.0MB	71.3MB	1024		AUTO	3	5	VC	IDE(AT)		(2,7)	RLL	28ms			7.5Mb	40K	20.0W		
94205-030	5.25	HALF		25.8MB	989		AUTO	17	2	3	VC ST506/412		(1,3)	RLL	28ms			5.0Mb				
94205-041	5.25	HALF		34.4MB	989		AUTO	17	2	4	VC ST506/412		(1,3)	RLL	28ms			5.0Mb				
94205-051	5.25	HALF	51.0MB	43.0MB	989		AUTO	17	3	5	VC ST506/412		(1,3)	RLL	960	28ms		5.0Mb	40K	18.0W		
94205-077	5.25	HALF	77.0MB	63.3MB	989		AUTO	26	3	5	VC ST506/412		(2,7)	RLL	980	28ms		7.5Mb	40K	18.0W		
94205-53	5.25	HALF	53.0MB	44.6MB	1024		AUTO	17	3	5	VC ST506/412		(1,3)	RLL	28ms			5.0Mb				
94208-062	5.25	HALF	62.0MB		967		AUTO	27	3	5	VC IDE(AT)		(2,7)	RLL				7.5Mb				
94208-075	5.25	HALF	75.0MB	60.0MB	989		AUTO	26	3	5	VC IDE(AT)		(2,7)	RLL	30ms	8.0ms		7.5Mb			COMPAQ, TYPE 47	
94208-51	5.25	HALF	51.0MB	43.0MB			AUTO				VC										COMPAQ, TYPE 17	
94295-051	5.25	FULL	51.0MB	43.0MB	989		AUTO	3	5	0	VC ST506/412		(1,3)	RLL	28ms			5.0Mb				

MODEL NUMBER	--SIZE--		-----CAPACITY-----		-----PHYSICAL-----							-LOGICAL-			TKS /IN.	--ACCESS--		XFER RATE	CACHE	MTBF	POWER USED	COMMENTS
	WTH.	HGT.	UNFORMAT	FORMATED	CYLS	PRE-COMP	LAND ZONE	S/TK	# PL	RW HD	HD AC	INTER-FACE	CYLS	S/TK		RW HD	RECORD METHOD					
94155-092	5.25	FULL	92.0MB	77.5MB	989	NONE	AUTO	17	5	9	VC	ST506/412			(1,3)RLL	980	28ms	5.0Mb		40K	28.0W	
CDC WREN III																						
94161-086	5.25	FULL		86.8MB	969	NONE	AUTO	35	3	5	VC	SCSI			(2,7)RLL		17ms					
94161-101	5.25	FULL		84.3MB	969	NONE	AUTO	34	3	5	VC	SCSI			(2,7)RLL		17ms					
94161-103	5.25	FULL		104.2MB	969	NONE	AUTO	35	3	6	VC	SCSI			(2,7)RLL		17ms	10.0Mb				
94161-121	5.25	FULL		121.6MB	969	NONE	AUTO	35	4	7	VC	SCSI			(2,7)RLL		17ms					
94161-138	5.25	FULL		138.9MB	969	NONE	AUTO	35	4	8	VC	SCSI			(2,7)RLL		17ms	10.0Mb				
94161-141	5.25	FULL		118.1MB	969	NONE	AUTO	34		7	VC	SCSI			(2,7)RLL		17ms	10.0Mb				
94161-155	5.25	FULL		151.8MB	969	NONE	AUTO	34		9	VC	SCSI			(2,7)RLL		17ms	10.0Mb				
94161-182	5.25	FULL	182.0MB	160.0MB	969	NONE	AUTO		5	9	VC	SCSI			(2,7)RLL		17ms	10.0Mb		100K	21.0W	
94166-086	5.25	FULL		86.8MB	969	NONE	AUTO	35	3	5	VC	ESDI			(2,7)RLL		17ms	10.0Mb				
94166-101	5.25	FULL		89.3MB	969	NONE	AUTO	36	3	5	VC	ESDI			(2,7)RLL		17ms	10.0Mb				
94166-103	5.25	FULL		104.2MB	969	NONE	AUTO	35	3	6	VC	ESDI			(2,7)RLL		17ms	10.0Mb				
94166-121	5.25	FULL	121.6MB	107.2MB	969	NONE	AUTO	36	4	7	VC	ESDI			(2,7)RLL		17ms	10.0Mb				
94166-138	5.25	FULL		138.9MB	969	NONE	AUTO	35	4	8	VC	ESDI			(2,7)RLL		17ms	10.0Mb				
94166-141	5.25	FULL		125.0MB	969	NONE	AUTO	36		7	VC	ESDI			(2,7)RLL		17ms	10.0Mb				
94166-161	5.25	FULL		142.9MB	969	NONE	AUTO	36		8	VC	ESDI			(2,7)RLL		17ms	10.0Mb				
94166-182	5.25	FULL	182.0MB	160.0MB	969		AUTO		5	9	VC	ESDI			(2,7)RLL	960	17ms	10.0Mb		100K	21.0W	
94211-091	5.25	HALF	106.0MB	91.0MB	969		AUTO		3	5	VC	SCSI			(2,7)RLL		18ms	10.0Mb		100K	20.0W	aka 94211-106
94211-106	5.25	HALF	106.0MB	91.0MB	969		AUTO		3	5	VC	SCSI			(2,7)RLL		18ms	10.0Mb		100K	20.0W	aka 94211-091
94216-106	5.25	HALF	106.0MB	94.0MB	969		AUTO		3	5	VC	ESDI			(2,7)RLL		18ms	10.0Mb		100K	20.0W	
CDC WREN IV																						
94171-300	5.25	FULL	300.4MB		1365		AUTO	MZ	5	9	VC	SCSI			(2,7)RLL		17ms					
94171-307	5.25	FULL	300.4MB		1412		AUTO	MZ		9	VC	SCSI			(2,7)RLL							
94171-327	5.25	FULL	300.4MB		1412		AUTO	MZ		9	VC	CSCI			(2,7)RLL							
94171-344	5.25	FULL	344.0MB		1549		AUTO	MZ	5	9	VC	SCSI			(2,7)RLL		18ms	12.0Mb				
94171-350	5.25	FULL	350.0MB	307.0MB	1549		AUTO	MZ	5	9	VC	SCSI			(2,7)RLL		17ms	12.0Mb		100K	30.0W	
94171-376	5.25	FULL	376.0MB	330.0MB	1549		AUTO	MZ	5	9	VC	SCSI			(2,7)RLL		18ms	12.0Mb		100K	30.0W	
94244-164	5.25	HALF	164.0MB	144.9MB	1747	NONE	AUTO	54	2	3	VC	IDE(AT)			(2,7)RLL		16ms					
94244-502	5.25	HALF	502.0MB				AUTO				VC	IDE(AT)			(2,7)RLL							
CDC WREN V																						

MODEL NUMBER	--SIZE--		-----CAPACITY-----		-----PHYSICAL-----							-LOGICAL-			RECORD METHOD	TKS /IN.	--ACCESS--		XFER RATE	CACHE	MTBF	POWER USED	COMMENTS
	WTH.	HGT.	UNFORMAT	FORMATED	CYLS	PRE-COMP	LAND ZONE	S/TK	#PL	RWHD	HDAC	INTER-FACE	CYLS	TK			HD	AVE.					
94171-375	5.25	FULL	375.0MB		1549	AUTO		5	9	VC	SCSI				1280	16ms		10.0Mb					
94181-385 RUN.	5.25	FULL	385.0MB	337.0MB		AUTO	MZ	8	15	VC	SCSI		(2,7)	RLL		11ms		15.0Mb		100K	21.0W		
94181-574	5.25	FULL	574.0MB		1549	AUTO	MZ	8	15	VC	SCSI		(2,7)	RLL		16ms		12.0Mb					
94181-702	5.25	FULL	702.0MB		1549	AUTO	MZ	8	15	VC	ESDI		(2,7)	RLL		16ms		12.0Mb					
94181-702	5.25	FULL	702.0MB	613.0MB	1549	AUTO	MZ	8	15	VC	SCSI		(2,7)	RLL	1280	17ms		14.0Mb		100K	21.0W		
94186-265	5.25	FULL	265.0MB	234.2MB	1412	AUTO	36	5	9	VC	ESDI		(2,7)	RLL				10.0Mb					
94186-324	5.25	FULL	324.0MB	286.3MB	1412	AUTO	36	6	11	VC	ESDI		(2,7)	RLL				10.0Mb					
94186-383	5.25	FULL	383.0MB	328.0MB	1412	AUTO		7	13	VC	ESDI		(2,7)	RLL	1280	18ms		10.0Mb		100K	21.0W		
94186-383	5.25	FULL	383.0MB		1412	AUTO		7	13	VC	SCSI		(2,7)	RLL		20ms		10.0Mb					
94186-383H	5.25	FULL	383.0MB	329.0MB	1224	AUTO		8	15	VC	ESDI		(2,7)	RLL	1280	15ms		10.0Mb		100K	21.0W		
94186-383H	5.25	FULL	383.0MB		1224	AUTO		8	15	VC	SCSI		(2,7)	RLL		15ms		10.0Mb					
94186-442	5.25	FULL	442.0MB	373.0MB	1412	AUTO		8	15	VC	ESDI		(2,7)	RLL	1280	16ms		10.0Mb		100K	21.0W		
94186-442	5.25	FULL	442.0MB		1412	AUTO		8	15	VC	SCSI		(2,7)	RLL		16ms		10.0Mb					
94221-125	5.25	HALF	125.0MB	110.0MB		AUTO	MZ	2	3	VC	SCSI		(2,7)	RLL		18ms		12.0Mb		100K	16.0W		
94221-169	5.25	HALF		158.9MB	1310	AUTO	MZ	3	5	VC	SCSI		(2,7)	RLL									
94221-184	5.25	HALF				AUTO	MZ			VC	SCSI		(2,7)	RLL									
94221-190	5.25	HALF	190.0MB		1547	AUTO		3	5	VC	SCSI		(2,7)	RLL		18ms		10.0Mb					
94221-209	5.25	HALF	209.0MB	183.0MB	1547	AUTO	MZ	3	5	VC	SCSI		(2,7)	RLL	1280	18ms		12.0Mb		100K	18.0W		
94601-767 RUN.2	5.25	FULL	767.0MB	676.0MB		AUTO	MZ	8	15	VC	SCSI		(2,7)	RLL		12ms		15.0Mb		100K	21.0W		
CDC WREN VI																							
94191-766	5.25	FULL	766.0MB	676.0MB	1632	AUTO	54	8	15	VC	SCSI		(2,7)	RLL		17ms	3.0ms	15.0Mb		100K	21.0W		
94196-766	5.25	FULL	766.0MB	676.0MB	1632	AUTO	54	8	15	VC	ESDI		(2,7)	RLL		17ms	3.0ms	15.0Mb		100K	22.0W		
94241-383	5.25	HALF	383.0MB	338.0MB		AUTO		4	7	VC	SCSI		(2,7)	RLL		14ms		18.0Mb		100K	16.0W		
94241-502	5.25	HALF	502.0MB	440.0MB		AUTO		4	7	VC	SCSI		(2,7)	RLL		16ms		20.0Mb		100K	16.0W		
94244-219	5.25	HALF	219.0MB	193.2MB	1747	NONE	AUTO	54	3	4	VC	IDE(AT)		(2,7)	RLL		16ms		15.0Mb		100K	16.0W	
94244-383	5.25	HALF	383.0MB	337.0MB	1747	AUTO		4	7	VC	IDE(AT)		(2,7)	RLL	1459	16ms		15.0Mb		100K	16.0W		
94246-182	5.25	HALF	182.0MB	160.7MB	1453	NONE	AUTO	54	3	4	VC	ESDI		(2,7)	RLL	1459	15ms		15.0Mb		100K	15.0W	
94246-383	5.25	HALF	383.0MB	337.0MB	1748	AUTO		4	7	VC	ESDI		(2,7)	RLL	1459	15ms		15.0Mb		100K	15.0W		
CDC WREN VII																							
94601-12G	5.25	FULL	1200.0MB	1050.0MB			MZ	8	15	VC	SCSI		RLL			15ms		19.0Mb		100K	24.0W		
CENTURY DATA																							

MODEL NUMBER	--SIZE--		-----CAPACITY-----		-----PHYSICAL-----							--LOGICAL--			XFER RATE	CACHE	MTBF	POWER USED	COMMENTS	
	WTH.	HGT.	UNFORMAT	FORMATED	CYLS	PRE-COMP	LAND ZONE	S/TK	#PL	RW HD	HD AC	INTER-FACE	CYLS	S/TK						RW HD
CAST-10203E	5.25	FULL		55.0MB	1050		AUTO	35	2	3	VC	ESDI			(2,7)RLL		28ms		10.0Mb	
CAST-10203S	5.25	FULL		55.0MB	1050		AUTO	35	2	3	VC	SCSI			(2,7)RLL		28ms		10.0Mb	
CAST-10304E	5.25	FULL	87.0MB	75.0MB	1050		AUTO	35	2	4	VC	ESDI			(2,7)RLL		28ms		10.0Mb	
CAST-10304S	5.25	FULL	87.0MB	75.0MB	1050		AUTO	35	2	4	VC	SCSI			(2,7)RLL		28ms		10.0Mb	
CAST-10305E	5.25	FULL		94.0MB	1050		AUTO	35	3	5	VC	ESDI			(2,7)RLL		28ms		10.0Mb	
CAST-10305S	5.25	FULL		94.0MB	1050		AUTO	35	3	5	VC	SCSI			(2,7)RLL		28ms		10.0Mb	
CAST-14404E	5.25	HALF		114.0MB	1590		AUTO	35	2	4	VC	ESDI			(2,7)RLL		25ms		10.0Mb	
CAST-14404S	5.25	HALF		114.0MB	1590		AUTO	35	2	4	VC	SCSI			(2,7)RLL		25ms		10.0Mb	
CAST-14405E	5.25	HALF	170.0MB	140.0MB	1590		AUTO	35	3	5	VC	ESDI			(2,7)RLL	1450	20ms		10.0Mb	
CAST-14405S	5.25	HALF	170.0MB	140.0MB	1590		AUTO	35	3	5	VC	SCSI			(2,7)RLL	1450	20ms		10.0Mb	
CAST-14406E	5.25	HALF	210.0MB	170.0MB	1590		AUTO	35	3	6	VC	ESDI			(2,7)RLL	1450	20ms		10.0Mb	
CAST-14406S	5.25	HALF	210.0MB	170.0MB	1590		AUTO	35	3	6	VC	SCSI			(2,7)RLL	1450	20ms		10.0Mb	
CAST-24509E	5.25	FULL		258.0MB	1599		AUTO	35	5	9	VC	ESDI			(2,7)RLL		18ms		10.0Mb	
CAST-24509S	5.25	FULL		258.0MB	1599		AUTO	35	5	9	VC	SCSI			(2,7)RLL		18ms		10.0Mb	
CAST-24611E	5.25	FULL		315.0MB	1599		AUTO	35	6	11	VC	ESDI			(2,7)RLL		18ms		10.0Mb	
CAST-24611S	5.25	FULL		315.0MB	1599		AUTO	35	6	11	VC	SCSI			(2,7)RLL		18ms		10.0Mb	
CAST-24713E	5.25	FULL		372.0MB	1599		AUTO	35	7	13	VC	ESDI			(2,7)RLL		18ms		10.0Mb	
CAST-24713S	5.25	FULL		372.0MB	1599		AUTO	35	7	13	VC	SCSI			(2,7)RLL		18ms		10.0Mb	
CMI																				
3426	5.25	HALF	26.0MB	20.0MB	615	256		17	2	4	SM	ST506/412			(1,3)RLL		85ms		5.0Mb	
5018H	5.25	FULL	18.0MB	15.0MB				17			SM	ST506/412			(1,3)RLL		85ms		5.0Mb	
5205	5.25	FULL	5.0MB	4.0MB	256	128		17	2	SM	ST506/412			(1,3)RLL					5.0Mb	
5206	5.25	FULL	6.0MB	5.0MB	306	256		17	2	SM	ST506/412			(1,3)RLL					5.0Mb	
5410	5.25	FULL	10.0MB	8.0MB	256	128		17	2	4	SM	ST506/412			(1,3)RLL				5.0Mb	
5412	5.25	FULL	12.0MB	10.0MB	306	128		17	2	4	SM	ST506/412			(1,3)RLL		85ms		5.0Mb	
5616	5.25	FULL	16.0MB	13.0MB	256	128		17	3	6	SM	ST506/412			(1,3)RLL				5.0Mb	
5619	5.25	FULL	19.0MB	15.0MB	306	128		17	3	6	SM	ST506/412			(1,3)RLL		85ms		5.0Mb	
6213	5.25	FULL	13.0MB	11.0MB	640	256		17	2	SM	ST506/412			(1,3)RLL					5.0Mb	
6426	5.25	FULL	26.0MB	21.8MB	640	256	640	17	2	4	SM	ST506/412			(1,3)RLL		39ms		5.0Mb	
6426S	5.25	FULL	26.0MB	21.0MB	615	300	615	17			SM	ST506/412			(1,3)RLL		39ms		5.0Mb	
6640	5.25	FULL	40.0MB	33.0MB	615	256		17	3	6	SM	ST506/412			(1,3)RLL		39ms		5.0Mb	



MODEL NUMBER	--SIZE--		-----CAPACITY----		-----PHYSICAL-----							-LOGICAL-			RECORD METHOD	TKS /IN.	--ACCESS--		XFER RATE	CACHE	MTBF	POWER USED	COMMENTS
	WTH.	HGT.	UNFORMAT	FORMATED	CYLS	PRE-COMP	LAND ZONE	S/TK	#PL	RWHD	HDAC	INTER-FACE	CYLS	TK			HD	AVE.					
7660	5.25	FULL	60.0MB	50.0MB	960	450		17	3	6	SM	ST506/412		(1,3)RLL				5.0Mb					
7880	5.25	FULL	80.0MB	67.0MB	960	450		17	4	8	SM	ST506/412		(1,3)RLL				5.0Mb					
CMS ENHANCE.																							
K100A3	3.50	HALF		104.9MB	776	NONE	AUTO	33	4	8	VC	IDE(AT)		(2,7)RLL	25ms	8.0ms	10.0Mb	32KB	20K	2.9W	(CONNER CP-3104)		
F115ESDI-T	5.25	FULL		114.0MB			AUTO					ESDI		(2,7)RLL	30ms		10.0Mb		25K	30.0W			
F150AT-CA	5.25	FULL		150.0MB			AUTO					ESDI		(2,7)RLL	17ms		10.0Mb		40K	21.0W			
F150AT-WCA	5.25	FULL		150.0MB			AUTO					ESDI		(2,7)RLL	17ms		10.0Mb		40K	21.0W			
F150EQ-WCA	5.25	FULL		150.0MB			AUTO							(2,7)RLL	17ms		10.0Mb		40K	20.0W			
F320AT-CA	5.25	FULL		320.0MB			AUTO					ESDI		(2,7)RLL	15ms		10.0Mb		40K	29.0W			
F70ESDI-T	5.25	FULL		73.0MB			AUTO					ESDI		(2,7)RLL	30ms		10.0Mb		25K	30.0W			
H330E1 PS Expr.	5.25	HALF		330.0MB	1780		AUTO	54	4	7	VC	ESDI		(2,7)RLL	14ms		15.0Mb		150K	14.3W			
H340E1 Expr.	5.25	HALF		340.0MB	1780		AUTO	54	4	7	VC	ESDI		(2,7)RLL	14ms		15.0Mb		150K	14.3W			
PSExpress 150	5.25	FULL		150.0MB			AUTO					ESDI		(2,7)RLL	17ms		10.0Mb		40K	21.0W			
PSExpress 320	5.25	FULL		320.0MB			AUTO					ESDI		(2,7)RLL	15ms		10.0Mb		40K	29.0W			
COGITO																							
CG-906	5.25		6.0MB	5.0MB	306	128		17	2	SM	ST506/412		(1,3)RLL				5.0Mb						
CG-912	5.25		12.0MB	11.0MB	306	128		17	4	SM	ST506/412		(1,3)RLL				5.0Mb						
PT-912	5.25		12.0MB	11.0MB	612	307		17	2	SM	ST506/412		(1,3)RLL				5.0Mb						
PT-925	5.25		25.0MB	21.0MB	612	307		17	4	SM	ST506/412		(1,3)RLL				5.0Mb						
CONNER																							
CP-1044 DERRING	1.80	10.5		42.6MB		NONE	AUTO	1	2	VC	PCMCIA				19ms		15.6Mb	32KB		0.75W			
CP-2020 KATO	2.50	0.7"		21.4MB	642	NONE	AUTO	32	1	2	VC	SCSI		(2,7)RLL	23ms		10.0Mb	8KB		1.5W			
CP-2024 KATO	2.50	0.7"		21.4MB	653	NONE	AUTO	32	1	2	VC	IDE-X,A		(2,7)RLL	1700	23ms	8.0ms	10.0Mb	8KB	100K	2.3W	3,433 RPM	
CP-2031	2.50			30.0MB			AUTO				VC			(2,7)RLL							COMPAQ OEM, TYPE 59		
CP-2034 PANCHO	2.50	0.8"		32.0MB	823	NONE	AUTO	38	1	2	VC	IDE(AT)	823	(2,7)RLL	2100	19ms	5.0ms	12.0Mb	32KB	100K	2.3W	3,433 RPM	
CP-2040 PANCHO	2.50	0.8"		42.6MB	548	NONE	AUTO	38	2	4	VC	SCSI		(2,7)RLL	1700	19ms	5.0ms	12.0Mb	32KB	50K	2.3W	88-BIT R/S ECC, 3,486 RPM	
CP-2044 PANCHO	2.50	0.8"		42.6MB	548	NONE	AUTO	38	2	4	VC	IDE(AT)		(2,7)RLL	1700	19ms	5.0ms	12.0Mb	32KB	100K	2.3W	3,486 RPM	
CP-2060 PANCHO	2.50	0.8"		64.0MB	823	NONE	AUTO	38	2	4	VC	SCSI		(2,7)RLL	2100	19ms	5.0ms	12.0Mb	32KB	50K	2.3W	88-BIT R/S ECC, 3,486 RPM	
CP-2061 PANCHO	2.50	0.8"		60.0MB			AUTO				VC			(2,7)RLL							COMPAQ OEM, TYPE 60		
CP-2064 PANCHO	2.50	0.8"		64.0MB	823	NONE	AUTO	38	2	4	VC	IDE(AT)	823	(2,7)RLL	2100	19ms	5.0ms	12.0Mb	32KB	100K	2.3W	3,486 RPM	
CP-2084 PANCHO	2.50	0.8"		85.2MB	1096	NONE	AUTO	38	2	4	VC	IDE(AT)	548	(1,7)RLL	2350	19ms	5.0ms	12.0Mb	32KB	150K	1.7W	3,486 RPM	

MODEL NUMBER	--SIZE--		-----CAPACITY-----		-----PHYSICAL-----					-LOGICAL-			--ACCESS--		XFER RATE	CACHE	MTBF	POWER USED	COMMENTS						
	WTH.	HGT.	UNFORMAT	FORMATED	CYLS	PRE-COMP	LAND ZONE	S/TK	# PL	RW HD AC	INTER-FACE	CYLS	S/TK	RW HD						RECORD METHOD	TKS /IN.	AVE. TK/TK			
CP-2088 HONSHU	2.50	19.0		85.0MB		NONE	AUTO	2	4	VC	IDE(AT)					19ms	12.0Mb	32KB	1.5W						
CP-2124 PANCHO	2.50	19.0		121.6MB	1120	NONE	AUTO	53	2	4	VC	IDE(AT)	560	53	8	(1,7)RLL	2450	16ms	5.0ms	18.0Mb	32KB	150K	1.3W	3,776 RPM	
CP-2250 TRIGGER	2.50	19.0		253.4MB		NONE	AUTO	3	6	VC	SCSI					12ms	23.0Mb	32KB	1.2W						
CP-2254 TRIGGER	2.50	19.0		253.4MB		NONE	AUTO	3	6	VC	IDE(AT)					12ms	23.0Mb	32KB	1.2W						
CP-XXXX SAHARA	2.50	0.5"		64.0MB		NONE	AUTO				VC					15ms									
CP-3000	3.50	1.0"		42.8MB	1045	NONE	AUTO	40	1	2	VC	IDE(AT)	980	17	5	(2,7)RLL	1400	28ms	11.0m	12.0Mb	8KB	100K	3.1W	3,557 RPM	
CP-30060 HOPI	3.50	1.0"		60.0MB	1524	NONE	AUTO	39	1	2	VC	SCSI				(1,7)RLL	1850	19ms	8.0ms	12.0Mb	64KB	150K	2.8W	3,399 RPM	
CP-30061 HOPI	3.50	1.0"		60.0MB			AUTO				VC					(2,7)RLL								COMPAQ OEM, TYPE 55	
CP-30064 [H] HOP	3.50	1.0"		60.8MB	1524	NONE	AUTO	39	1	2	VC	IDE(AT)	762	39	4	(1,7)RLL	1850	19ms	8.0ms	12.0Mb	64KB	100K	3.3W	MiG HEADS, 3,399 RPM	
CP-30069 HOPI	3.50	1.0"		60.0MB	1524	NONE	AUTO	39	1	2	VC	MCA				(1,7)RLL	1850	19ms	8.0ms	12.0Mb	64KB	150K	2.8W	3,399 RPM	
CP-30080 HOPI	3.50	1.0"		84.0MB	1053	NONE	AUTO	39	2	4	VC	SCSI				(2,7)RLL		19ms		12.0Mb	8KB		2.8W		
CP-30080E JAGUA	3.50	25.4		85.0MB	1806	NONE	AUTO	46	1	2	VC	SCSI				(1,7)RLL	2150	17ms	8.0ms	16.0Mb	32KB	150K	2.5W	3,833 RPM	
CP-30084 HOPI	3.50	1.0"		84.1MB	1053	NONE	AUTO	39	4	8	VC	IDE(AT)	526	39	8	(1,7)RLL	1400	19ms	8.0ms	12.0Mb	64KB	100K	3.3W	MiG HEADS, 3,399 RPM	
CP-30084E JAGUA	3.50	25.4		85.0MB	1806	NONE	AUTO	46	1	2	VC	IDE(AT)	903	46	4	(1,7)RLL	2150	17ms	3.0ms	16.0Mb	32KB	150K	2.5W	3,833 RPM	
CP-30100 [H] HOP	3.50	1.0"		121.7MB	1524	NONE	AUTO	39	2	4	VC	SCSI				(2,7)RLL	1850	19ms	8.0ms	12.0Mb	64KB	50K	3.3W	48-BIT ECC, 3,399 RPM	
CP-30101 HOPI	3.50	1.0"		121.0MB			AUTO				VC					(2,7)RLL								COMPAQ OEM, TYPE 50	
CP-30104 HOPI	3.50	1.0"		121.7MB	1524	NONE	AUTO	39	2	4	VC	IDE(AT)	762	39	8	(1,7)RLL	1850	19ms	8.0ms	12.0Mb	64KB	100K	3.3W	MiG HEADS	
CP-30104H ALLEG	3.50	25.4		120.0MB	1522	NONE	AUTO	39	2	4	VC	IDE(AT)	762	39	8	(1,7)RLL	1850	19ms	8.0ms	12.0Mb	32KB	150K	2.8W	MiG HEADS, 3,399 RPM	
CP-30124 FILEPR	3.50	25.4		125.0MB		NONE	AUTO	1	2	VC	IDE(AT)					14ms	24.0Mb	32KB	2.8W						
CP-30170 FILEPR	3.50	25.4		170.0MB		NONE	AUTO	1	2	VC	SCSI-2					13ms	31.2Mb	64KB	250K	2.5W		4,500 RPM			
CP-30170E JAGUA	3.50	25.4		170.0MB	1806	NONE	AUTO	46	2	4	VC	SCSI				(1,7)RLL	2150	17ms	8.0ms	16.0Mb	32KB	150K	2.5W	3,833 RPM	
CP-30174	3.50	1.0"		162.0MB	1806	NONE	AUTO	46	2	4	VC		903	46	8										
CP-30174 FILEPR	3.50	25.4		170.0MB		NONE	AUTO	1	2	VC	IDE(AT)					13ms	31.2Mb	64KB	250K	2.5W		4,500 RPM			
CP-30174E JAGUA	3.50	25.4		170.0MB	1806	NONE	AUTO	46	2	4	VC	IDE(AT)	903	46	8	(1,7)RLL	2150	17ms	3.0ms	16.0Mb	32KB	150K	2.5W	MiG HEADS, 3,833 RPM	
CP-3020	3.50	1.0"		21.5MB	632	NONE	AUTO	33	1	2	VC	SCSI				(2,7)RLL	1150	27ms	8.0ms	10.0Mb	8KB	50K	3.1W	3,575 RPM	
CP-30200 COUGAR	3.50	25.4		212.6MB	2124	NONE	AUTO	49	2	4	VC	SCSI-2				(1,7)RLL	2496	12ms	3.0ms	20.0Mb	256KB	150K	5.2W	R/S ECC, 4,500 RPM	
CP-30204 COUGAR	3.50	25.4		212.6MB	2119	NONE	AUTO	49	2	4	VC	IDE(AT)	683	38	16	(1,7)RLL	2496	12ms	3.0ms	20.0Mb	256KB	150K	5.2W	88-BIT R/S ECC, 4,498 RPM	
CP-3021	3.50			21.5MB			AUTO				VC					(2,7)RLL								COMPAQ OEM, TYPE 2	
CP-3021i	3.50			21.5MB			AUTO				VC					(2,7)RLL								COMPAQ OEM, TYPE 2	
CP-3022	3.50			21.5MB	636		AUTO	1	2	VC	IDE(AT)					(2,7)RLL	27ms		10.0Mb		50K	4.2W			
CP-3024	3.50	1.0"		21.5MB	636	NONE	AUTO	33	1	2	VC	IDE(AT)				(2,7)RLL	1150	27ms		10.0Mb		50K	4.2W		

MODEL NUMBER	--SIZE--		-----CAPACITY-----		-----PHYSICAL-----							--LOGICAL--			ACCESS	XFER RATE	CACHE	MTBF	POWER USED	COMMENTS
	WTH.	HGT.	UNFORMAT	FORMATED	CYLS	PRE-COMP	LAND ZONE	S/TK	# PL	RW HD AC	INTER-FACE	CYLS	S/TK	RW HD						
CP-30254	FILEPR	3.50	1.0"	251.0MB	NONE	AUTO	2	4	VC	IDE(AT)						14ms	24.0Mb	32KB	2.8W	OPTIONAL 64KB CACHE
CP-30340	FILEPR	3.50	25.4	343.0MB	NONE	AUTO	2	4	VC	SCSI-2						13ms	31.2Mb	64KB 250K	2.5W	4,500 RPM
CP-30344	FILEPR	3.50	25.4	343.0MB	NONE	AUTO	2	4	VC	IDE(AT)						13ms	31.2Mb	64KB 250K	2.5W	4,500 RPM
CP-3040		3.50	1.0"	42.0MB	1026	NONE	AUTO	40	1	2	VC	SCSI		(2,7)RLL	1400	25ms 8.0ms	12.0Mb	8KB 50K	3.3W	3,557 RPM
CP-3041		3.50		40.1MB		AUTO				VC			(2,7)RLL							COMPAQ OEM, TYPE 22
CP-3044		3.50	1.0"	42.0MB	1047	NONE	AUTO	40	1	2	VC	IDE(AT)	980 17 5	(2,7)RLL	1400	25ms 8.0ms	12.0Mb	8KB 50K	3.1W	3,557 RPM
CP-30540	AEGEAN	3.50	25.4	545.9MB	NONE	AUTO	3	6	VC	SCSI-2F						10ms	35.8Mb 256KB	5.0W		
CP-30544	AEGEAN	3.50	25.4	545.9MB	NONE	AUTO	3	6	VC	IDE(AT)						10ms	35.8Mb 256KB	5.0W		
CP-3100		3.50	HALF	104.9MB	776	NONE	AUTO	33	4	8	VC	SCSI		(2,7)RLL	1200	25ms 8.0ms	10.0Mb	32KB 50K	5.0W	3,575 RPM
CP-3101		3.50	HALF	104.9MB		AUTO				VC			(2,7)RLL							COMPAQ OEM, TYPE 45
CP-3102		3.50	HALF	104.9MB	776	AUTO	4	8	VC	IDE(AT)				(2,7)RLL	1150	25ms 8.0ms	12.0Mb	16KB 50K	2.9W	
CP-3104		3.50	HALF	104.9MB	776	NONE	AUTO	33	4	8	VC	IDE(AT)	925 17 13	(2,7)RLL	1150	25ms 8.0ms	10.0Mb	32KB 50K	4.3W	3,575 RPM
CP-3111		3.50	HALF	104.9MB	776	AUTO	33	4	8	VC	IDE(AT)			(2,7)RLL	1150	25ms 8.0ms	10.0Mb	16KB 50K	3.0W	COMPAQ OEM, TYPE 33
CP-3114		3.50	HALF	106.0MB	832	NONE	AUTO	33	4	8	VC									
CP-31370	BAJA	3.50	41.3	1371.8MB	NONE	AUTO	7	14	VC	SCSI-2F						11ms	35.5Mb 256KB	6.2W		
CP-31374	BAJA	3.50	41.3	1371.8MB	NONE	AUTO	7	14	VC	IDE(AT)						11ms	35.5Mb 256KB	6.2W		
CP-3180		3.50	HALF	84.0MB	832	NONE	AUTO	33	3	6	VC	SCSI		(2,7)RLL	1200	25ms 8.0ms	10.0Mb	32KB 50K	5.0W	3,575 RPM
CP-3181		3.50	HALF	84.0MB		AUTO				VC			(2,7)RLL							COMPAQ OEM, TYPE 27
CP-3184		3.50	HALF	84.0MB	832	NONE	AUTO	33	3	6	VC	IDE(AT)	832 33 6	(2,7)RLL	1150	25ms 8.0ms	10.0Mb	32KB 50K	3.1W	3,575 RPM
CP-3200F		3.50	HALF	212.6MB	1366	NONE	AUTO	38	4	8	VC	SCSI		(1,7)RLL	1700	16ms 5.0ms	12.0Mb	64KB 150K	4.5W	3,485 RPM
CP-3201F		3.50	HALF	210.0MB		AUTO				VC			(2,7)RLL							COMPAQ OEM, TYPE 51
CP-3201G		3.50	HALF	210.0MB		AUTO				VC			(2,7)RLL							COMPAQ OEM, TYPE 51
CP-3204		3.50	HALF	215.3MB	1348	NONE	AUTO	39	4	8	VC	IDE(AT)	683 38 16	(2,7)RLL	1700	19ms 5.0ms	12.0Mb	64KB 50K	6.0W	3,485 RPM
CP-3204F		3.50	HALF	212.6MB	1366	NONE	AUTO	38	4	8	VC	IDE(AT)	683 38 16	(1,7)RLL	1700	16ms 5.0ms	12.0Mb	64KB 50K	4.5W	3,485 RPM
CP-3209F		3.50	HALF	212.6MB	1366	NONE	AUTO	38	4	8	VC	MCA		(1,7)RLL	1700	16ms 5.0ms	12.0Mb	64KB 150K	4.2W	MICROCHANNEL CTRLR., 3,485 RPM
CP-321		3.50	HALF	20.0MB	752	NONE	AUTO	1	2	VC	IDE(AT)			(2,7)RLL						COMPAQ OEM, TYPE 2
CP-3304		3.50	HALF	324.0MB	1318	NONE	AUTO				VC		659 63 16							
CP-3360	SUMMIT	3.50	41.3	362.5MB	1807	NONE	AUTO	49	4	8	VC	SCSI-2		(2,7)RLL	2150	12ms 3.0ms	20.0Mb 256KB 150K	6.7W	88-BIT R/S ECC, 4,498 RPM	
CP-3364	SUMMIT	3.50	41.3	362.8MB	1808	NONE	AUTO	49	4	8	VC	IDE(AT)	702 63 16	(2,7)RLL	2150	12ms 3.0ms	20.0Mb 256KB 150K	6.7W	88-BIT R/S ECC, 4,498 RPM	
CP-340		3.50	HALF	42.9MB	788	NONE	AUTO	26	2	4	VC	SCSI		(2,7)RLL	1000	29ms	7.5Mb	20K	4.3W	
CP-341		3.50	HALF	42.9MB		NONE	AUTO				VC			(2,7)RLL						COMPAQ OEM, TYPE 17

MODEL NUMBER	--SIZE--		-----CAPACITY-----		-----PHYSICAL-----							--LOGICAL--			RECORD METHOD	TKS /IN.	--ACCESS--		XFER RATE	CACHE	MTBF	POWER USED	COMMENTS	
	WTH.	HGT.	UNFORMAT	FORMATED	CYLS	PRE-COMP	LAND ZONE	S/TK	# PL	RW HD	AC	INTER-FACE	CYLS	S/TK			RW HD	AVE.						TK/TK
CP-341i	3.50	HALF		42.9MB	805	NONE	AUTO	26	2	4	VC	IDE(AT)	788	26	4	(2,7)RLL		7.5Mb				COMPAQ OEM, TYPE 43		
CP-342	3.50	HALF		42.9MB	805	NONE	AUTO	26	2	4	VC	IDE(AT)				(2,7)RLL	29ms	7.5Mb						
CP-343	3.50	HALF		42.9MB	805		AUTO		2	4	VC	IDE				(2,7)RLL	1000	29ms	7.5Mb			FOR ZENITH PORTABLE		
CP-344	3.50	HALF		42.9MB	805	NONE	AUTO	26	2	4	VC	IDE(AT)				(2,7)RLL	1000	29ms	7.5Mb	20K	4.3W			
CP-3500	SUMMIT	3.50	HALF	510.0MB	1695		AUTO	49	6	12	VC	SCSI				(2,7)RLL	2100	12ms	4.0ms	16.0Mb	256KB	100K	4.5W	3,609 RPM
CP-3504	SUMMIT	3.50	HALF	510.0MB	1695	NONE	AUTO	49	6	12	VC	IDE(AT)	987	63	16	(2,7)RLL	2100	12ms	4.0ms	16.0Mb	256KB	100K	4.5W	3,609 RPM
CP-3540	SUMMIT	3.50	41.3	543.7MB	1807	NONE	AUTO	49	6	12	VC	SCSI-2				(2,7)RLL	2150	12ms	3.0ms	20.0Mb	256KB	150K	6.7W	88-BIT R/S ECC, 4,498 RPM
CP-3544	SUMMIT	3.50	41.3	543.7MB	1808	NONE	AUTO	49	6	12	VC	IDE(AT)	1024	63	16	(2,7)RLL	2150	12ms	3.0ms	20.0Mb	256KB	150K	6.7W	88-BIT R/S ECC, 4,498 RPM
CP-4021	STUBBY	3.50	0.8"	21.6MB			AUTO				VC					(2,7)RLL							COMPAQ OEM, TYPE 2	
CP-4024	STUBBY	3.50	0.8"	21.6MB	627		AUTO		1	2	VC	IDE-X,A				(2,7)RLL	1150	29ms	9.0Mb	8KB	40K	1.5W		
CP-4041	STUBBY	3.50	0.8"	42.6MB			AUTO				VC					(2,7)RLL							COMPAQ OEM, TYPE 53	
CP-4044	STUBBY	3.50	0.8"	42.6MB	1104		AUTO		1	2	VC	IDE-X,A				(2,7)RLL	1400	29ms	9.0Mb	8KB	40K	1.5W		
CP-4084	GATOR	3.50	0.8"	85.0MB			AUTO				VC	IDE(AT)				(2,7)RLL		19ms	12.0Mb	32KB		1.5W		
CP-XXXX	MONTERE	3.50	1.0"			NONE	AUTO				VC							14ms						
CP-XXXX	SOFSTOR	3.50		85.0MB		NONE	AUTO				VC													PREINSTALLED SOFTWARE
CP-XXXX	SOFSTOR	3.50		170.0MB		NONE	AUTO				VC													PREINSTALLED SOFTWARE
CP-5500	CHINOOK	5.25	HALF	510.0MB	2034	NONE	AUTO	50	5	20	VC	SCSI-2				RLL	2360	12ms	3.0ms	22.4Mb	512KB	150K	11.1W	DUAL HEAD ASSEMBLYS, 4,498 RPM
CORE INTL.																								
AT-150	5.25	FULL	156.0MB				AUTO					ESDI				(2,7)RLL		16ms	10.0Mb		99K	25.0W		
AT-30	5.25	FULL	31.0MB	733				17	3	5		ST506/412				(1,3)RLL		26ms	5.0Mb					
AT-30R	5.25	FULL	48.0MB	733				26	3	5		ST506/412				(2,7)RLL		26ms	7.5Mb					
AT-32	5.25	HALF	31.0MB	733				17	3	5		ST506/412				(1,3)RLL		21ms	5.0Mb					
AT-32R	5.25	HALF	48.0MB	733				26	3	5		ST506/412				(2,7)RLL		21ms	7.5Mb					
AT-40	5.25	FULL	40.0MB	924				17	3	5		ST506/412				(1,3)RLL		26ms	5.0Mb					
AT-40R	5.25	FULL	61.0MB	924				26	3	5		ST506/412				(2,7)RLL		26ms	7.5Mb					
AT-63	5.25	FULL	63.0MB	42.0MB	988			17	3	5		ST506/412				(1,3)RLL		26ms	5.0Mb					
AT-63R	5.25	FULL	65.0MB	988				26	3	5		ST506/412				(2,7)RLL		26ms	7.5Mb					
AT-72	5.25	FULL	72.0MB	924				17	5	9		ST506/412				(1,3)RLL		26ms	5.0Mb					
AT-72R	5.25	FULL	107.0MB	924				26	5	9		ST506/412				(2,7)RLL		26ms	7.5Mb					
HC-1000S	5.25		1200.0MB				AUTO			14		SCSI				(2,7)RLL		18ms	12.3Mb		150K			
HC-100F	5.25	FULL	101.0MB				AUTO					ESDI				(2,7)RLL		9ms	15.0Mb		150K	28.0W		

MODEL NUMBER	--SIZE--		-----CAPACITY-----		-----PHYSICAL-----						-LOGICAL-			RECORD METHOD	TKS /IN.	--ACCESS--		XFER RATE	CACHE	MTBF	POWER USED	COMMENTS
	WTH.	HGT.	UNFORMAT	FORMATED	CYLS	PRE-COMP	LAND ZONE	S/TK	#PL	RWHD	HDAC	INTER-FACE	CYLS			TK	HD					
HC-150	5.25	FULL	156.0MB		969			35	3	5	ESDI			(2,7)RLL	16ms		10.0Mb					
HC-175	5.25		177.8MB			AUTO				8	ESDI			(2,7)RLL	16ms		10.0Mb	150K	11.0W			
HC-200	5.25		200.0MB							8	IDE(AT)				16ms		8.0Mb	150K				
HC-260	5.25	FULL	260.0MB		1212			35	6	12	ESDI			(2,7)RLL	16ms		10.0Mb					
HC-310	5.25	FULL	311.0MB		1582	AUTO		35	6	12	ESDI			(2,7)RLL	16ms		10.0Mb	150K	28.0W			
HC-315	5.25	FULL	340.0MB		1447	AUTO		57	4	8	ESDI			(2,7)RLL	16ms		20.0Mb	150K	20.0W			
HC-380	5.25	FULL	383.0MB			AUTO					ESDI			(2,7)RLL	16ms		10.0Mb	150K	28.0W			
HC-40	5.25	FULL	40.0MB		564			35	2	4	ESDI			(2,7)RLL	10ms		10.0Mb					
HC-650	5.25	FULL	658.0MB		1661	AUTO		53	8	15	ESDI			(2,7)RLL	16ms		20.0Mb	150K	20.0W			
HC-650S	5.25	FULL	663.0MB			AUTO				14	SCSI			(2,7)RLL	18ms		12.3Mb	150K				
HC-655	5.25	FULL	680.0MB		1447	AUTO		57	8	16	ESDI			(2,7)RLL	16ms		20.0Mb	150K	20.0W			
OPTIMA-30	5.25	HALF	32.0MB		733			17	3	5	ST506/412			(1,3)RLL	21ms		5.0Mb					
OPTIMA-30R	5.25	HALF	48.0MB		733			26	3	5	ST506/412			(2,7)RLL	21ms		7.5Mb					
OPTIMA-40	5.25	HALF	41.0MB		963			17	3	5	ST506/412			(1,3)RLL	26ms		5.0Mb					
OPTIMA-40R	5.25	HALF	64.0MB		963			26	3	5	ST506/412			(2,7)RLL	26ms		7.5Mb					
OPTIMA-70	5.25	FULL	71.0MB		918			17	5	9	ST506/412			(1,3)RLL	26ms		5.0Mb					
OPTIMA-70R	5.25	FULL	109.0MB		918			26	5	9	ST506/412			(2,7)RLL	26ms		7.5Mb					
HC-90	5.5	HALF	91.0MB		969	AUTO		35	3	5	ESDI			(2,7)RLL	15ms		10.0Mb	99K	11.0W			
D.E.C.																						
DSP3053L	3.50	HALF	535.0MB			NONE	AUTO				SCSI-2FW				10ms						5,400 RPM	
DSP3080	3.50	HALF	852.0MB			NONE	AUTO				SCSI-2				10ms	1.0ms	21.6Mb	512KB			R/S ECC, 5,400 RPM	
DSP3107L	3.50	HALF	1070.0MB			NONE	AUTO				SCSI-2FW				10ms						5,400 RPM	
DSP3133L	3.50	HALF	1330.0MB			NONE	AUTO				SCSI-2FW				10ms						5,400 RPM	
DSP3160	3.50	HALF	1600.0MB			NONE	AUTO				SCSI-2							300K			R/S ECC, 5,400 RPM	
DSP3210	3.50	HALF	2100.0MB			NONE	AUTO				SCSI-2FW				10ms						5,400 RPM	
R223L	3.50	HALF	120.0MB								SCSI				33ms		12.0Mb					
R224	3.50	HALF	209.0MB								SCSI				24ms		12.0Mb					
R225	3.50	HALF	426.0MB								SCSI				21ms		25.6Mb					
DSP5200	5.25	FULL	2000.0MB			NONE	AUTO				SCSI-2				12ms	3.0ms	17.6Mb	512KB			5,400 RPM	
DSP5350	5.25	FULL	3500.0MB			NONE	AUTO				SCSI-2							300K				
ESP510	5.25	FULL	107.0MB								SCSI-2				.3ms						SOLID STATE DISK, R/S ECC	

MODEL NUMBER	--SIZE--		-----CAPACITY----		-----PHYSICAL-----					--LOGICAL--			TKS /IN.	--ACCESS-- AVE. TK/TK	XFER RATE	CACHE	MTBF	POWER USED	COMMENTS
	WTH.	HGT.	UNFORMAT	FORMATED	PRE- CYLS	LAND COMP	S/ ZONE	# TK	RW PL	HD HD	AC	INTER- FACE							
ESP530	5.25	FULL		267.0MB							SCSI-2				.3ms				SOLID STATE DISK, R/S ECC
DATA TECHNOLOGY																			
DTC-HF12	5.25	HALF	12.8MB	10.0MB	301		78	1	2		SCSI		(1,3)RLL	333	65ms	25.0m	2.0Mb	10K	19.0W
DTC-HF24	5.25	HALF	23.9MB	20.2MB	506		78	1	2		SCSI		(1,3)RLL	666	60ms	25.0m	2.6Mb	10K	17.0W
DAUPHIN TECH.																			
DYNADRIVE 85	2.50			85.0MB											14ms				PORTABLE/REMOVEABLE MEDIA
DISCTRON																			
D-503	5.25	FULL		3.0MB	153	128	17	1	2		ST506/412		(1,3)RLL				5.0Mb		
D-504	5.25	FULL		4.0MB	215	128	17	1	2		ST506/412		(1,3)RLL				5.0Mb		
D-506	5.25	FULL	6.0MB	5.0MB	153	128	17	2	4		ST506/412		(1,3)RLL				5.0Mb		
D-507	5.25	FULL	7.0MB	5.0MB	306	128	17	1	2		ST506/412		(1,3)RLL				5.0Mb		
D-509	5.25	FULL	9.0MB	8.0MB	215	128	17	2	4		ST506/412		(1,3)RLL				5.0Mb		
D-512	5.25	FULL	12.0MB	11.0MB	153	128	17	4	8		ST506/412		(1,3)RLL				5.0Mb		
D-513	5.25	FULL	13.0MB	11.0MB	215	128	17	3	6		ST506/412		(1,3)RLL				5.0Mb		
D-514	5.25	FULL	14.0MB	11.0MB	306	128	17	2	4		ST506/412		(1,3)RLL				5.0Mb		
D-518	5.25	FULL	18.0MB	15.0MB	215	128	17	4	8		ST506/412		(1,3)RLL				5.0Mb		
D-519	5.25	FULL	19.0MB	16.0MB	306	128	17	3	6		ST506/412		(1,3)RLL				5.0Mb		
D-525	5.25	FULL	25.0MB	20.0MB															
D-526	5.25	FULL	26.0MB	21.0MB	306	128	17	4	8		ST506/412		(1,3)RLL				5.0Mb		
DISK TECH.																			
DISCTEC RHD-20	2.50	SUBH		20.0MB			17				IDE(AT)		(1,3)RLL		23ms		5.0Mb		REMOVABLE
DMA																			
306	5.25			11.0MB	612	400	17	1	2		ST506/412		(1,3)RLL				5.0Mb		REMOVABLE
DYNATEK SYSTEMS																			
NDS1.2			1000.0MB	1658		AUTO	85	8	15	VC	SCSI		(1,7)RLL	15ms	4.0ms		256KB	200K	EXTERNAL
NDS180			173.0MB	1334		AUTO	34	4	8	VC	SCSI		(1,7)RLL	20ms	8.0ms		64KB	200K	EXTERNAL
NDS2.0			1600.0MB	1893		AUTO	* 12	20	VC	SCSI		(1,7)RLL	11ms	2.0ms		256KB	200K	*103 SECTORS/TRACK,	EXTERNAL
NDS350			340.0MB	1658		AUTO	34	5	8	VC	SCSI		(1,7)RLL	16ms	4.0ms		64KB	200K	EXTERNAL
NDS520			520.0MB	1435		AUTO	60	6	11	VC	SCSI		(1,7)RLL	12ms	3.0ms		256KB	200K	EXTERNAL
NDS650			640.0MB	1658		AUTO	53	5	9	VC	SCSI		(1,7)RLL	16ms	4.0ms		256KB	200K	EXTERNAL
ELCOH																			

MODEL NUMBER	--SIZE--		-----CAPACITY----		-----PHYSICAL-----						-LOGICAL-			TKS /IN.	--ACCESS-- AVE. TK/TK	XFER RATE	CACHE	MTBF	POWER USED	COMMENTS	
	WTH.	HGT.	UNFORMAT	FORMATED	PRE- CYLS	LAND COMP	S/ ZONE	# TK	RW PL	HD HD	AC	INTER- FACE	S/ CYLS								RW TK
DISCACHE-10			10.0MB		320			17	2	4		ST506/412			(1,3)RLL					5.0Mb	
DISCACHE-20			20.0MB		320			17	4	8		ST506/412			(1,3)RLL					5.0Mb	
EMULEX																					
EMS/760	5.25		663.0MB									ESDI								18ms	
ER2E/760	5.25		663.0MB									ESDI								17ms	50K
ES36/760-1	5.25		663.0MB									ESDI								17ms	
EPSON																					
HD-560			20.0MB																		
HD-720			20.0MB																		
HD-850			10.0MB		306			17	2	4		ST506/412			(1,3)RLL						
HD-860			20.0MB		612			17	2	4		ST506/412			(1,3)RLL						
ESPERT																					
EP-340A	3.50	HALF	42.8MB					2	4			IDE			(2,7)RLL					25ms	
FUJI																					
FK301-13	3.50	HALF	13.0MB	10.0MB	306	128		17	2	4		ST506/412			(1,3)RLL	65ms				5.0Mb	
FK302-13	3.50	HALF	13.0MB	10.0MB	612	307		17	1	2		ST506/412			(1,3)RLL	65ms				5.0Mb	
FK302-26	3.50	HALF	26.0MB	21.0MB	612	307		17	2	4		ST506/412			(1,3)RLL	65ms				5.0Mb	
FK302-39	3.50	HALF	39.0MB	32.0MB	612	307		17	3	6		ST506/412			(1,3)RLL	65ms				5.0Mb	
FK303-52	3.50	HALF	52.0MB	40.0MB	615			17	4	8		ST506/412			(1,3)RLL	65ms				5.0Mb	
FK305-26	3.50	HALF	26.0MB	21.0MB	615			17	2	4		ST506/412			(1,3)RLL	65ms				5.0Mb	
FK305-26R	3.50	HALF			615		26					ST506/412			(2,7)RLL					7.5Mb	
FK305-39	3.50	HALF	39.0MB	32.0MB	615			17	3	6		ST506/412			(1,3)RLL	65ms				5.0Mb	
FK305-39R	3.50	HALF	39.0MB	32.0MB	615		26	2	4			ST506/412			(2,7)RLL	65ms				7.5Mb	
FK305-58R	3.50	HALF	58.0MB	49.0MB	615		26	3	6			ST506/412			(2,7)RLL	65ms				7.5Mb	
FK308S-39R	3.50	HALF	39.0MB	32.0MB	615		26	2	4			SCSI			(2,7)RLL	65ms				7.5Mb	
FK308S-58R	3.50	HALF	58.0MB	45.0MB	615		26	3	6			SCSI			(2,7)RLL	65ms				7.5Mb	
FK309-26	3.50	HALF	26.0MB	21.0MB	615			17	2	4		ST506/412			(1,3)RLL	65ms				5.0Mb	
FK309-39	3.50	HALF	39.0MB	32.0MB	615			17	3	6		ST506/412			(1,3)RLL	65ms				5.0Mb	
FK309S-50R	3.50	HALF	50.0MB	41.0MB	615		26	2	4			SCSI			(2,7)RLL	65ms				7.5Mb	
FUJITSU																					
M2230AS			5.0MB		320			17	1	2		ST506/412			(1,3)RLL					5.0Mb	

MODEL NUMBER	--SIZE--		-----CAPACITY-----		-----PHYSICAL-----						-LOGICAL-			TKS /IN.	--ACCESS--		XFER RATE	CACHE	MTBF	POWER USED	COMMENTS	
	WTH.	HGT.	UNFORMAT	FORMATED	CYLS	PRE-COMP	LAND ZONE	S/TK	# PL	RW HD AC	INTER-FACE	CYLS	S/TK		RW HD	RECORD METHOD						AVE. TK/TK
M2233AS			10.0MB	320			17	2	4	ST506/412				(1,3)RLL			5.0Mb					
M2234AS			15.0MB	320			17	3	6	ST506/412				(1,3)RLL			5.0Mb					
M2235AS			20.0MB	320			17	4	8	ST506/412				(1,3)RLL			5.0Mb					
M2637	2.50		250.0MB		NONE	AUTO				VC SCSI-2F					15ms		40.0Mb	150K			4,500 RPM	
M2225DR	3.50	HALF	32.0MB	615			26	2	4	ST506/412				(2,7)RLL	35ms		7.5Mb					
M2226D2	3.50	HALF	30.0MB	615	300		17	3	6	ST506/412				(1,3)RLL	35ms		5.0Mb					
M2226DR	3.50	HALF	49.0MB	615			26	3	6	ST506/412				(2,7)RLL	35ms		7.5Mb					
M2227D2	3.50	HALF	51.2MB	42.8MB	615	128	17	4	8	SM ST506/412				(1,3)RLL	35ms	8.0ms	5.0Mb	30K	7.5W			
M2227DR	3.50	HALF	65.0MB	615			26	4	8	ST506/412				(2,7)RLL	35ms		7.5Mb					
M2611SA	3.50	SUBH	45.1MB	1334				1	2	VC SCSI				(1,7)RLL	25ms	10.0m	7.4Mb	50K				
M2611T	3.50	SUBH	45.1MB	1334	NONE	AUTO	34	1	2	VC IDE(AT)	667	33	4	(1,7)RLL	25ms	10.0m	7.4Mb	64KB	50K	6.6W	3,490 RPM	
M2612SA	3.50	HALF	90.8MB	1334				2	4	VC SCSI				(1,7)RLL	25ms	10.0m	7.4Mb	50K				
M2612T-ET	3.50	HALF	90.1MB	1334	NONE	AUTO	34	2	4	VC IDE(AT)	667	33	8	(1,7)RLL	25ms	10.0m	7.4Mb	64KB	50K	7.8W	3,490 RPM	
M2613SA	3.50	HALF	136.6MB	1334				3	6	VC SCSI				(1,7)RLL	25ms	10.0m	7.4Mb	50K				
M2613T-ET	3.50	HALF	135.2MB	1334	NONE	AUTO	34	3	6	VC IDE(AT)	667	33	12	(1,7)RLL	25ms	10.0m	7.4Mb	64KB	50K	7.8W	3,490 RPM	
M2614SA	3.50	HALF	182.4MB	1334	NONE	AUTO	34	4	8	VC SCSI-2				(1,7)RLL	25ms	10.0m	7.4Mb	50K				
M2614T-ET	3.50	HALF	180.3MB	1334	NONE	AUTO	34	4	8	VC IDE(AT)	667	33	16	(1,7)RLL	25ms	10.0m	7.4Mb	64KB	50K	7.8W	3,490 RPM	
M2616T	3.50	HALF			NONE					VC IDE(AT)	771	33	8	(1,7)RLL								
M2622SA	3.50	HALF	330.2MB	1435	NONE	AUTO	MZ	4	7	VC SCSI-2				(1,7)RLL	12ms	3.0ms	24.0Mb	240KB	200K	12.5W	MZR:4-ZONE, 4,400 RPM	
M2622T	3.50	HALF	330.2MB	1435						VC IDE(AT)				(1,7)RLL	12ms	3.0ms	24.0Mb	240KB	200K	12.5W	MZR:4-ZONE, 4,400 RPM	
M2623SA	3.50	HALF	425.1MB	1435	NONE	AUTO	MZ	5	9	VC SCSI-2				(1,7)RLL	12ms	3.0ms	24.0Mb	240KB	200K	12.5W	MZR:4-ZONE, 4,400 RPM	
M2623T	3.50	HALF	425.1MB	1435						VC IDE(AT)				(1,7)RLL	12ms	3.0ms	24.0Mb	240KB	200K	12.5W	MZR:4-ZONE, 4,400 RPM	
M2624SA EAGLET	3.50	HALF	520.1MB	1435	NONE	AUTO	MZ	6	11	VC SCSI-2				(1,7)RLL	1751	12ms	3.0ms	24.0Mb	240KB	200K	12.5W	MZR:4-ZONE, 4,400 RPM
M2624T EAGLET	3.50	HALF	520.1MB	1435	NONE	AUTO	MZ	6	11	VC IDE(AT)	995	63	16	(1,7)RLL	1751	12ms	3.0ms	24.0Mb	240KB	200K	12.5W	MZR:4-ZONE, 4,400 RPM
M2694	3.50	HALF	1000.0MB		NONE	AUTO				VC SCSI-2FW												
M2235AS	5.25	HALF	26.7MB	22.3MB	320	128	17	4	8	ST506/412				(1,3)RLL	300	85ms	18.0m	5.0Mb	20K	27.0W		
M2241AS	5.25	FULL	26.0MB	754	375		17	2	4	ST506/412				(1,3)RLL			5.0Mb					
M2242AS	5.25	FULL	54.9MB	43.0MB	754	375	AUTO	17	4	7	VC ST506/412			(1,3)RLL	760	30ms	8.0ms	5.0Mb	30K	30.0W		
M2243AS	5.25	FULL	86.3MB	67.0MB	754	375	AUTO	17	6	11	VC ST506/412			(1,3)RLL	760	30ms	8.0ms	5.0Mb	30K	30.0W		
M2243R	5.25	HALF	110.0MB	1186			26	4	7	ST506/412				(2,7)RLL	25ms		7.5Mb					
M2243T	5.25	HALF	68.0MB	1186			17	4	7	ST506/412				(1,3)RLL	25ms		5.0Mb					



MODEL NUMBER	--SIZE--		-----CAPACITY-----		-----PHYSICAL-----				INTER- FACE	-LOGICAL-			RECORD METHOD	TKS /IN.	--ACCESS--		XFER RATE	CACHE	MTBF	POWER USED	COMMENTS
	WTH.	HGT.	UNFORMAT	FORMATED	CYLS	PRE- COMP	LAND ZONE	S/ TK		# PL	RW HD	HD AC			CYLS	TK					
M2244E	5.25	FULL	73.0MB		823			35	3	5				ESDI	(2,7)RLL	25ms	10.0Mb				
M2244SA	5.25	FULL	73.0MB		823			35	3	5				SCSI	(2,7)RLL	25ms	10.0Mb				
M2245E	5.25	FULL	120.0MB		823			35	4	7				ESDI	(2,7)RLL	25ms	10.0Mb				
M2245SA	5.25	FULL	120.0MB		823			35	4	7				SCSI	(2,7)RLL	25ms	10.0Mb				
M2246E	5.25	FULL	172.0MB	138.0MB	823			35	6	10				ESDI	(2,7)RLL	850 25ms 5.0ms	10.0Mb	30K			
M2246SA	5.25	FULL	172.0MB	138.0MB	823			35	6	10				SCSI	(2,7)RLL	850 25ms 5.0ms	10.0Mb	30K			
M2247E	5.25	FULL			1243				4	7				ESDI	(2,7)RLL						
M2249E	5.25	FULL	389.0MB		1243				8	15				ESDI	(1,7)RLL	850 18ms 4.0ms	10.0Mb	30K			
M2249S	5.25	FULL	389.0MB		1243				8	15				SCSI	(1,7)RLL	850 18ms 4.0ms	10.0Mb	30K			
M2261E	5.25	FULL	415.0MB	321.0MB	1658				MZ	8				ESDI	(2,7)RLL	16ms	15.0Mb	64KB 200K 34.0W			*24-96
M2261S	5.25	FULL	415.0MB	321.0MB	1658					8				SCSI	(2,7)RLL	16ms	40.0Mb	200K 34.0W			
M2263E	5.25	FULL	778.0MB	650.0MB	1658				MZ	8	15			ESDI	(1,7)RLL	1726 16ms 4.0ms	15.0Mb	64KB 200K 28.0W			*24-96
M2263S	5.25	FULL	778.0MB	650.0MB	1658					8	15			SCSI	(1,7)RLL	1726 16ms 4.0ms	40.0Mb	200K 28.0W			
M2266SA	5.25	FULL	1266.0MB											SCSI	RLL	15ms	24.0Mb	200K			
M2652H	5.25	FULL		1600.0MB						12	20	VC		SCSI-2S		11ms	38.0Mb	200K 40.0W			5,400 RPM
M2652HD	5.25	FULL		1600.0MB						12	20	VC		SCSI-2		11ms	38.0Mb	200K 40.0W			5,400 RPM, DUAL PORT
M2652P	5.25	FULL		1600.0MB						12	20	VC		IPI-2		11ms	38.0Mb	200K 40.0W			5,400 RPM
M2652S	5.25	FULL		1600.0MB						12	20	VC		SCSI-2F		11ms	38.0Mb	200K 40.0W			5,400 RPM
M2654	5.25	FULL		2000.0MB		NONE	AUTO							VC							
M2392K	8.00	FULL	2020.0MB											ESMD			24.0Mb				
M2671P	8.00	FULL	2640.0MB							9	15			IPI-2							4,340 RPM
HEWLETT-PKD.																					
KITTYHAWK II PS	1.30	10.5		42.8MB		NONE	AUTO			2	4	VC		PCMCIA		2700	15ms	8.8Mb	300K		5,400 RPM, GLASS PLATTERS
KITTYHAWK PSM	1.30	0.4"		21.4MB		NONE	AUTO			2	3	VC		IDE		2400	18ms	7.2Mb	300K 1.6W		5,400 RPM, GLASS PLATTERS
KITTYHAWK PSM	1.30	0.4"		21.4MB		NONE	AUTO			2	3	VC		PCMCIA-3		2400	18ms	7.2Mb	300K 1.6W		5,400 RPM, GLASS PLATTERS
HP-97500-85600	3.50	HALF		20.0MB										SCSI							
HP-97500-85620	3.50	HALF		20.0MB										SCSI							
HP-C2233A	3.50	HALF		238.0MB		NONE	AUTO			3	5	VC		IDE(AT)		13ms	20.6Mb	150K 11.6W			
HP-C2233S	3.50	HALF	281.0MB	234.0MB	1511	NONE	AUTO	MZ		3	5	VC		SCSI-2	(2,7)RLL	1850 13ms 3.0ms	20.6Mb	64KB 150K 12.3W			REED/SOLOMON ECC
HP-C2234A	3.50	HALF		334.0MB		NONE	AUTO			4	7	VC		IDE(AT)		13ms	20.6Mb	150K 11.6W			
HP-C2234S	3.50	HALF	394.0MB	328.0MB	1511	NONE	AUTO	MZ		4	7	VC		SCSI-2	(2,7)RLL	1850 13ms 3.0ms	20.6Mb	64KB 150K 12.3W			REED/SOLOMON ECC

MODEL NUMBER	--SIZE--		-----CAPACITY-----		-----PHYSICAL-----					-LOGICAL-			RECORD METHOD	TKS /IN.	--ACCESS--		XFER RATE	CACHE	MTBF	POWER USED	COMMENTS
	WTH.	HGT.	UNFORMAT	FORMATED	PRE-CYLS	LAND COMP	S/ZONE	# PL	RW HD AC	INTER-FACE	S/TK	RW HD			AVE. TK/TK						
HP-C2235A	3.50	HALF		429.0MB	NONE	AUTO		5	9	VC	IDE(AT)				13ms		20.6mb		150K	11.6W	
HP-C2235S	3.50	HALF	506.0MB	422.0MB	1511		AUTO	M2	5	9	VC	SCSI-2	(2,7)RLL	1850	13ms	3.0ms	20.6mb	64KB	150K	12.3W	MZR:3-ZONE, REED/SOLOMON ECC
HP-C2247	3.50	HALF		1050.0MB	NONE	AUTO					VC				11ms				300K		
HP-97532D	5.25	FULL	136.2MB	107.6MB	1663			64	2	4	VC	SCSI(D)	(2,7)RLL	1590	18ms	3.5ms	12.0mb	16KB	150K	21.0W	3,348 RPM
HP-97532E	5.25	FULL	136.2MB	103.0MB	1663		AUTO	64	2	4	VC	ESDI	(2,7)RLL	1590	17ms	3.5ms	10.0mb		150K	19.0W	
HP-97532S	5.25	FULL	136.2MB	107.6MB	1663		AUTO	64	2	4	VC	SCSI	(2,7)RLL	1590	18ms	3.5ms	12.0mb	16KB	150K	19.0W	3,348 RPM
HP-97532T	5.25	FULL	136.2MB	107.6MB	1663		AUTO	64	2	4	VC	SCSI	(2,7)RLL	1590	18ms	3.5ms	12.0mb	16KB	150K	19.0W	3,348 RPM
HP-97533D	5.25	FULL	204.3MB	161.5MB	1663		AUTO	64	4	8	VC	SCSI(D)	(2,7)RLL	1590	18ms	3.5ms	12.0mb	16KB	150K	21.0W	3,348 RPM
HP-97533E	5.25	FULL	204.3MB	155.0MB	1663		AUTO	64	4	8	VC	ESDI	(2,7)RLL	1590	17ms	3.5ms	10.0mb		150K	27.0W	
HP-97533S	5.25	FULL	204.3MB	161.5MB	1663		AUTO	64	4	8	VC	SCSI	(2,7)RLL	1590	18ms	3.5ms	12.0mb	16KB	150K	19.0W	3,348 RPM
HP-97533T	5.25	FULL	204.3MB	161.5MB	1663		AUTO	64	4	8	VC	SCSI	(2,7)RLL	1590	18ms	3.5ms	12.0mb	16KB	150K	19.0W	3,348 RPM
HP-97536D	5.25	FULL	408.7MB	323.0MB	1663		AUTO	64	6	12	VC	SCSI(D)	(2,7)RLL	1590	18ms	3.5ms	12.0mb	16KB	150K	21.0W	3,348 RPM
HP-97536E	5.25	FULL	408.7MB	311.0MB	1663		AUTO	64	6	12	VC	ESDI	(2,7)RLL	1590	17ms	3.5ms	10.0mb		150K	30.0W	
HP-97536S	5.25	FULL	408.7MB	323.0MB	1663		AUTO	64	6	12	VC	SCSI	(2,7)RLL	1590	18ms	3.5ms	12.0mb	16KB	150K	19.0W	3,348 RPM
HP-97536T	5.25	FULL	408.7MB	323.0MB	1663		AUTO	64	6	12	VC	SCSI	(2,7)RLL	1509	18ms	3.5ms	12.0mb	16KB	150K	19.0W	3,348 RPM
HP-97544D	5.25	FULL	397.0MB	331.0MB	1447		AUTO	56	4	8	VC	SCSI(D)	(2,7)RLL	1667	17ms	3.5ms	20.0mb	64KB	150K	35.0W	4,002 RPM
HP-97544E	5.25	FULL	397.0MB	340.0MB	1457		AUTO	57	4	8	VC	ESDI	(2,7)RLL	1667	17ms	3.5ms	20.0mb		150K	33.0W	4,002 RPM
HP-97544P	5.25	FULL	397.0MB	331.0MB	1447		AUTO	56	4	8	VC	SCSI-2D	(2,7)RLL	1667	17ms	3.5ms	20.0mb	64KB	150K	35.0W	REED/SOLOMON ECC, 4,002 RPM
HP-97544S	5.25	FULL	397.0MB	331.0MB	1447		AUTO	56	4	8	VC	SCSI	(2,7)RLL	1667	17ms	3.5ms	20.0mb	64KB	150K	34.0W	4,002 RPM
HP-97544T	5.25	FULL	397.0MB	331.0MB	1447		AUTO	56	4	8	VC	SCSI-2	(2,7)RLL	1667	17ms	3.5ms	20.0mb	64KB	150K	34.0W	REED/SOLOMON ECC, 4,002 RPM
HP-97548D	5.25	FULL	795.0MB	663.0MB	1447		AUTO	56	8	16	VC	SCSI(D)	(2,7)RLL	1667	17ms	3.5ms	20.0mb	64KB	150K	35.0W	4,002 RPM
HP-97548E	5.25	FULL	795.0MB	680.0MB	1457		AUTO	57	8	16	VC	ESDI	(2,7)RLL	1667	17ms	3.5ms	20.0mb		150K	33.0W	4,002 RPM
HP-97548P	5.25	FULL	795.0MB	663.0MB	1447		AUTO	56	8	16	VC	SCSI-2D	(2,7)RLL	1667	17ms	3.5ms	20.0mb	64KB	150K	35.0W	REED/SOLOMON ECC, 4,002 RPM
HP-97548S	5.25	FULL	795.0MB	663.0MB	1447		AUTO	56	8	16	VC	SCSI	(2,7)RLL	1667	17ms	3.5ms	20.0mb	64KB	150K	34.0W	4,002 RPM
HP-97548T	5.25	FULL	795.0MB	663.0MB	1447		AUTO	56	8	16	VC	SCSI-2	(2,7)RLL	1667	17ms	3.5ms	20.0mb	64KB	150K	34.0W	REED/SOLOMON ECC, 4,002 RPM
HP-97549P	5.25	FULL	1180.0MB	1000.0MB	1911		AUTO	64	8	16	VC	SCSI-2D	(2,7)RLL	1850	18ms	3.5ms	22.8mb	128KB	150K	35.0W	REED/SOLOMON ECC, 4,002 RPM
HP-97549T	5.25	FULL	1180.0MB	1000.0MB	1911		AUTO	64	8	16	VC	SCSI-2	(2,7)RLL	1850	18ms	3.5ms	22.8mb	128KB	150K	34.0W	REED/SOLOMON ECC, 4,002 RPM
HP-97556E	5.25	FULL	793.0MB	681.0MB	1680		AUTO	72	6	11	VC	ESDI	(2,7)RLL	1865	15ms	3.0ms	23.0mb		150K	20.0W	4,002 RPM
HP-97556P	5.25	FULL	793.0MB	673.0MB	1670		AUTO	72	6	11	VC	SCSI-2D	(2,7)RLL	1863	15ms	3.0ms	23.0mb	128KB	150K	20.0W	REED/SOLOMON ECC, 4,002 RPM
HP-97556T	5.25	FULL	793.0MB	673.0MB	1670		AUTO	72	6	11	VC	SCSI-2	(2,7)RLL	1863	15ms	3.0ms	23.0mb	128KB	150K	20.0W	REED/SOLOMON ECC, 4,002 RPM
HP-97558E	5.25	FULL	1260.0MB	1084.0MB	1961		AUTO	72	8	15	VC	ESDI	(2,7)RLL	1865	15ms	3.0ms	23.0mb		150K	20.0W	4,002 RPM

MODEL NUMBER	--SIZE--		-----CAPACITY-----		-----PHYSICAL-----							-LOGICAL-			--ACCESS--		XFER RATE	CACHE	MTBF	POWER USED	COMMENTS		
	WTH.	HGT.	UNFORMAT	FORMATED	CYLS	PRE-COMP	LAND ZONE	S/TK	#PL	RWHD	HDAC	INTER-FACE	CYLS	TK	HD	RECORD METHOD						TKS /IN.	AVE. TK/TK
HP-97558P	5.25	FULL	1263.0MB	1075.0MB	1952		AUTO	72	8	15	VC	SCSI-2D			(2,7)RLL	1863	15ms	3.0ms	23.0Mb	128KB	150K	20.0W	REED/SOLOMON ECC, 4,002 RPM
HP-97558T	5.25	FULL	1263.0MB	1075.0MB	1952		AUTO	72	8	15	VC	SCSI-2			(2,7)RLL	1863	15ms	3.0ms	23.0Mb	128KB	150K	20.0W	REED/SOLOMON ECC, 4,002 RPM
HP-97560E	5.25	FULL	1600.0MB	1374.0MB	1961		AUTO	72	10	19	VC	ESDI			(2,7)RLL	1865	15ms	3.0ms	23.0Mb		150K	20.0W	4,002 RPM
HP-97560P	5.25	FULL	1600.0MB	1363.0MB	1952		AUTO	72	10	19	VC	SCSI-2D			(2,7)RLL	1863	15ms	3.0ms	23.0Mb	128KB	150K	20.0W	REED/SOLOMON ECC, 4,002 RPM
HP-97560T	5.25	FULL	1600.0MB	1363.0MB	1952		AUTO	72	10	19	VC	SCSI-2			(2,7)RLL	1863	15ms	3.0ms	23.0Mb	128KB	150K	20.0W	REED/SOLOMON ECC, 4,002 RPM
HP-C3007	5.25	FULL	1612.0MB	1370.0MB	2255	NONE	AUTO	MZ	7	13	VC	SCSI-2					12ms	2.5ms	42.0Mb	256KB	300K	31.0W	REED/SOLOMON ECC, 5,400 RPM
HP-C3007-001	5.25	FULL	1612.0MB	1370.0MB	2255	NONE	AUTO	MZ	7	13	VC	SCSI-2F					12ms	2.5ms		256KB	300K	31.0W	R/S ECC, FAST SCSI, 5,400 RPM
HP-C3007-012	5.25	FULL	1612.0MB	1370.0MB	2255	NONE	AUTO	MZ	7	13	VC	SCSI-2WFD					12ms	2.5ms		256KB	300K	33.0W	R/S ECC, F&W&D SCSI, 5,400 RPM
HP-C3007-022	5.25	FULL	1612.0MB	1370.0MB	2255	NONE	AUTO	MZ	7	13	VC	SCSI-2FD					12ms	2.5ms		256KB	300K	36.0W	R/S ECC, F&D SCSI, 5,400 RPM
HP-C3009	5.25	FULL	2108.0MB	1792.0MB	2255	NONE	AUTO	MZ	9	17	VC	SCSI-2					12ms	2.5ms		256KB	300K	31.0W	REED/SOLOMON ECC, 5,400 RPM
HP-C3009-001	5.25	FULL	2108.0MB	1792.0MB	2255	NONE	AUTO	MZ	9	17	VC	SCSI-2F					12ms	2.5ms	42.0Mb	256KB	300K	31.0W	R/S ECC, FAST SCSI, 5,400 RPM
HP-C3009-012	5.25	FULL	2108.0MB	1792.0MB	2255	NONE	AUTO	MZ	9	17	VC	SCSI-2WFD					12ms	2.5ms		256KB	300K	33.0W	R/S ECC, F&W&D SCSI, 5,400 RPM
HP-C3009-022	5.25	FULL	2108.0MB	1792.0MB	2255	NONE	AUTO	MZ	9	17	VC	SCSI-2FD					12ms	2.5ms		256KB	300K	36.0W	R/S ECC, F&D SCSI, 5,400 RPM
HP-C3010	5.25	FULL	2356.0MB	2003.0MB	2255	NONE	AUTO	MZ	10	19	VC	SCSI-2					12ms	2.5ms		256KB	300K	31.0W	REED/SOLOMON ECC, 5,400 RPM
HP-C3010-001	5.25	FULL	2356.0MB	2003.0MB	2255	NONE	AUTO	MZ	10	19	VC	SCSI-2F					12ms	2.5ms	42.0Mb	256KB	300K	31.0W	R/S ECC, FAST SCSI, 5,400 RPM
HP-C3010-012	5.25	FULL	2356.0MB	2003.0MB	2255	NONE	AUTO	MZ	10	19	VC	SCSI-2WFD					12ms	2.5ms		256KB	300K	33.0W	R/S ECC, F&W&D SCSI, 5,400 RPM
HP-C3010-022	5.25	FULL	2356.0MB	2003.0MB	2255	NONE	AUTO	MZ	10	19	VC	SCSI-2FD					12ms	2.5ms		256KB	300K	36.0W	R/S ECC, F&D SCSI, 5,400 RPM
HP-C3010-100	5.25	FULL	1207.0MB	1027.0MB	1100	NONE	AUTO	96	10	19	VC	SCSI-2					9ms	2.5ms		256KB	300K		REED/SOLOMON ECC, 5,400 RPM
HP-D1660A	5.25	FULL		333.0MB	1457		AUTO	57		8	VC	ESDI			(2,7)RLL		16ms		20.0Mb	64KB	150K	21.0W	
HP-D1661A	5.25	FULL		667.0MB	1457		AUTO	57		16	VC	ESDI			(2,7)RLL		16ms		20.0Mb	64KB	150K	21.0W	
HITACHI																							
DK301-1	3.50	HALF		10.0MB	306	128		17	2	4		ST506/412			(1,3)RLL		85ms		5.0Mb				
DK301-2	3.50	HALF		15.0MB	306	128		17	3	6		ST506/412			(1,3)RLL		85ms		5.0Mb				
DK312C-20	3.50	HALF		209.0MB			AUTO		5	10	VC	SCSI			(2,7)RLL	1660	16ms	7.0ms	32.0Mb	32KB	150K		
DK312C-25	3.50	HALF		251.0MB			AUTO		6	12	VC	SCSI			(2,7)RLL	1660	16ms	7.0ms	32.0Mb	32KB	150K		
DK314C-41	3.50	HALF		419.0MB			AUTO		7	14	VC	SCSI			(2,7)RLL	1800	17ms	7.0ms	16.2Mb	64KB	150K		
DK315C-11	3.50	HALF		1100.0MB		NONE	AUTO		8	15	VC	SCSI-2F			(1,7)RLL		12ms		22.4Mb	256KB	200K	10.0W	4,500 RPM
DK315C-14	3.50	HALF		1400.0MB		NONE	AUTO		8	15	VC	SCSI-2F			(1,7)RLL		12ms		38.4Mb	256KB	200K	10.0W	4,500 RPM
DK505-2	5.25	FULL		21.0MB	615			17	2	4		ST506/412			(1,3)RLL								
DK511-3	5.25	FULL		28.0MB	699	256		17	3	5		ST506/412			(1,3)RLL		30ms		5.0Mb				
DK511-5	5.25	FULL		41.0MB	699	256		17	4	7		ST506/412			(1,3)RLL		30ms		5.0Mb				

MODEL NUMBER	--SIZE--		-----CAPACITY-----		-----PHYSICAL-----							--LOGICAL--			RECORD METHOD	TKS /IN.	--ACCESS--		XFER RATE	CACHE	MTBF	POWER USED	COMMENTS
	WTH.	HGT.	UNFORMAT	FORMATED	CYLS	PRE-COMP	LAND ZONE	S/TK	# PL	RW HD	AC	INTER-FACE	CYLS	TK			HD	AVE.					
DK511-8	5.25	FULL		67.0MB	823			17	5	10		ST506/412	(1,3)	RLL	23ms		5.0Mb						
DK512-12	5.25	FULL		94.0MB	823				4	7		ESDI	(2,7)	RLL	23ms		10.0Mb						
DK512-17	5.25	FULL		134.0MB	823				5	10		ESDI	(2,7)	RLL	28ms		10.0Mb						
DK512-8	5.25	FULL		67.0MB	823				3	5		ESDI	(2,7)	RLL	23ms		10.0Mb						
DK512C-12	5.25	FULL		94.0MB	823				4	7		SCSI	(2,7)	RLL	23ms		10.0Mb						
DK512C-17	5.25	FULL		134.0MB	819				5	10		SCSI	(2,7)	RLL	23ms		10.0Mb						
DK512C-8	5.25	FULL		67.0MB	823				3	5		SCSI	(2,7)	RLL	23ms		10.0Mb						
DK514-38	5.25	FULL	382.3MB	330.1MB	903		AUTO	51	8	14	VC	ESDI	(2,7)	RLL	1033	16ms	14.5Mb		30K	30.0W			
DK514C-38	5.25	FULL		321.8MB	903		AUTO	51	8	14	VC	SCSI	(2,7)	RLL	1033	16ms	12.0Mb		30K	30.0W			
DK514S-38	5.25	FULL	382.3MB	330.1MB	903		AUTO	51	8	14	VC	ESMD	(2,7)	RLL	1033	16ms	15.0Mb		30K	30.0W			
DK515-12	5.25	FULL	1229.0MB				AUTO			15	VC	ESDI	(2,7)	RLL		14ms	22.0Mb		150K				
DK515-78	5.25	FULL	780.0MB	673.0MB	1361	NONE	AUTO	69	8	14	VC	ESDI	(2,7)	RLL	1296	16ms	20.0Mb		150K	31.5W			
DK515C-78	5.25	FULL		670.5MB	1361	NONE	AUTO	69	8	14	VC	SCSI	(2,7)	RLL	1296	16ms	20.0Mb		150K	30.0W			
DK515S-78	5.25	FULL	780.0MB	673.0MB		NONE	AUTO		8	14	VC	E-SMD				16ms	20.0Mb		150K	33.5W			
DK516-12	5.25	FULL	1230.0MB				AUTO				VC	ESDI				14ms	22.0Mb		100K				
DK516-15	5.25	FULL	1540.0MB	1320.0MB		NONE	AUTO		8	15	VC	ESDI				14ms	22.0Mb		150K	35.0W			
DK516C-16	5.25	FULL	1651.0MB	1342.0MB		NONE	AUTO		8	15	VC	SCSI-2				14ms	24.0Mb		150K	37.5W			
DK517-26	5.25	FULL	2600.0MB	1900.0MB			AUTO				VC	SCSI-2				12ms	38.4Mb	512KB		31.0W			5,400 RPM
DK517C-37	5.25	FULL	3700.0MB	2900.0MB		NONE	AUTO		12	21	VC	SCSI-2F				13ms	38.4Mb	512KB	200K	31.0W			5,400 RPM
DK521-5	5.25	HALF		51.0MB	823			17	3	6		ST506/412	(1,3)	RLL	25ms		5.0Mb						
DK522-10	5.25	HALF	103.0MB	91.0MB	823		AUTO	36	4	6	VC	ESDI	(2,7)	RLL	960	25ms	10.0Mb		30K	19.5W			
DK522C-10	5.25	HALF	103.0MB	87.5MB	819		AUTO	35	4	6	VC	SCSI	(2,7)	RLL	960	25ms	12.0Mb		30K	22.0W			
SV-F501-18	5.25	HALF		200.0MB		NONE	AUTO		5	10	VC	SCSI				28ms		40K	33.0W				SSD OPTIONAL HARD DISK DRIVE
SV-F502-18	5.25	FULL		200.0MB		NONE	AUTO		5	10	VC	SCSI				28ms		40K	54.0W				SSD OPTIONAL HARD DISK DRIVE
SV502C-32D	5.25	FULL		128.0MB		NONE						SCSI-D				.4ms	32.0Mb		100K	28.0W			SOLID STATE DISK, 32-128 MB
SV502C-32F	5.25	FULL		160.0MB		NONE						SCSI				.4ms	32.0Mb		100K	24.0W			SOLID STATE DISK, 32-160 MB
SV502C-32H	5.25	HALF		64.0MB		NONE						SCSI				.4ms	32.0Mb		100K	18.0W			SOLID STATE DISK, 32-64 MB
SV502C-64D	5.25	FULL		256.0MB		NONE						SCSI-D				.4ms	32.0Mb		100K	28.0W			SOLID STATE DISK, 64-256 MB
SV502C-64F	5.25	FULL		320.0MB		NONE						SCSI				.4ms	32.0Mb		100K	24.0W			SOLID STATE DISK, 64-320 MB
SV502C-64H	5.25	HALF		128.0MB		NONE						SCSI				.4ms	32.0Mb		100K	18.0W			SOLID STATE DISK, 64-128 MB

MODEL NUMBER	--SIZE--		-----CAPACITY-----		-----PHYSICAL-----							-LOGICAL-			TKS /IN.	--ACCESS--		XFER RATE	CACHE	MTBF	POWER USED	COMMENTS
	WTH.	HGT.	UNFORMAT	FORMATED	CYLS	PRE-COMP	LAND ZONE	S/TK	# PL	RW HD	HD AC	INTER-FACE	CYLS	TK		HD	RECORD METHOD					
0667-85			71.0MB	583			36	4	7		ESDI				(2,7)RLL							
30/2.5	2.50		30.0MB								VC					20ms	9.0Mb			4.0W		
60/2.5	2.50		60.0MB								VC					20ms	9.0Mb			4.0W		
WD-2120	2.50	17.0	126.0MB	1248	NONE	AUTO	50	2	4	VC	PS/2(MCA)		2436	17ms	5.0ms		32KB	150K	2.1W			
WD-240	2.50	12.7	42.9MB	1120	NONE	AUTO	38	1	2	VC	PS/2(MCA)		2199	19ms	5.5ms			150K	2.2W			
WD-280	2.50	17.0	85.9MB	1120	NONE	AUTO	38	2	4	VC	PS/2(MCA)		2199	17ms	5.5ms			150K	2.3W			
WDA-2120	2.50	17.0	126.0MB	1248	NONE	AUTO	50	2	4	VC	IDE(AT)		2436	17ms	5.0ms		32KB	150K	2.1W			
WDA-240	2.50	12.7	43.1MB	1122	NONE	AUTO	38	1	2	VC	IDE(AT)		2199	19ms	5.5ms			150K	2.2W			
WDA-280	2.50	17.0	86.2MB	1122	NONE	AUTO	38	2	4	VC	IDE(AT)		2199	17ms	5.5ms			150K	2.3W			
WDA-S260	2.50	12.7	63.0MB	2496	NONE	AUTO	50	1	2	VC	IDE(AT)		2436	17ms	5.0ms		32KB	150K	2.0W			
WDS-240	2.50	12.7	42.9MB	1120	NONE	AUTO	38	1	2	VC	SCSI		2199	19ms	5.5ms			150K	2.2W			
WDS-280	2.50	17.0	85.9MB	1120	NONE	AUTO	38	2	4	VC	SCSI		2199	17ms	5.5ms			150K	2.3W			
0661-371	3.50	41.3	371.0MB	320.0MB	949	NONE	AUTO	48	8	14	VC	SCSI-2	(1,7)RLL	1201	13ms	2.5ms	16.0Mb	64KB	300K	11.9W	4,316 RPM	
0661-467	3.50	41.3	467.0MB	400.0MB	1199	NONE	AUTO	48	8	14	VC	SCSI-2	(1,7)RLL	1469	12ms	2.0ms	16.0Mb	128KB	300K	11.9W	4,316 RPM	
0663-E12	3.50	41.3	1044.0MB			NONE	AUTO		7	14	VC	SCSI-2F		2685	11ms	0.6ms		256KB	500K	10.1W	4,317 RPM	
0663-E15	3.50	41.3	1206.0MB			NONE	AUTO		8	16	VC	SCSI-2F		2685	11ms	0.6ms		256KB	500K	10.1W	4,317 RPM	
0663-H12	3.50	HALF	1004.0MB				AUTO			14	VC	SCSI-2	(1,7)RLL		10ms							
0664-M1H	3.50	41.3	2013.7MB	2870	NONE	AUTO			8	15	VC	SCSI-2F		3168	11ms	0.6ms		512KB	750K	12.7W	5,400 RPM	
0664-N1H	3.50	41.3	2013.7MB	2870	NONE	AUTO			8	15	VC	SCSI-2FW		3168	11ms	0.6ms		512KB	750K	12.7W	68-PIN WIDE SCSI, 5,400 RPM	
0664-P1S	3.50	41.3	2000.0MB	1741.0MB	2304	NONE	AUTO		8	15	VC	IPI-2		3168	11ms			750K	14.2W		5,400 RPM	
320	3.50	HALF	320.0MB						8		VC											
WD-160	3.50	HALF	160.0MB						8		VC	SCSI-2			16ms							
WD-3120	3.50	HALF	120.0MB	820	NONE	AUTO	MZ	3	6		IDE(AT)		(2,7)RLL	19ms		13.5Mb	64KB	100K	10.0W		MZR:2-ZONE, 3,662 RPM	
WD-3160	3.50	41.3	206.4MB	160.0MB	1021	NONE	AUTO	39	4	8	VC	PS/2(MCA)	(1,7)RLL	1517	16ms	5.0ms			110K	13.1W		
WD-3168	3.50	HALF	157.3MB						8		VC	PS/2(MCA)			23ms		10.0Mb		45K			
WD-380	3.50	41.3	103.5MB	80.0MB	1021	NONE	AUTO	39	2	4	VC	PS/2(MCA)		1517	16ms	5.0ms			110K	13.1W		
WD-40S	3.50	HALF	40.8MB						2		VC	SCSI			17ms							
WDA-3160	3.50	41.3	206.4MB	160.0MB	1021	NONE	AUTO	39	4	8	VC	IDE(AT)	(1,7)RLL	1517	16ms	5.0ms	12.0Mb	32KB	110K	13.1W		
WDA-380	3.50	41.3	103.5	80.0MB	1021	NONE	AUTO	39	2	4	VC	IDE(AT)		1517	16ms	5.0ms			110K	13.1W		
WDA-L160	3.50	19.9	171.4MB	1923	NONE	AUTO	44	2	4	VC	IDE(AT)		2200	16ms	5.0ms			150K				
WDA-L80	3.50	19.9	85.6MB	1923	NONE	AUTO	44	1	2	VC	IDE(AT)		2200	16ms	4.0ms			150K				

MODEL NUMBER	--SIZE--		-----CAPACITY-----		-----PHYSICAL-----						--LOGICAL--			TKS /IN.	--ACCESS--		XFER RATE	CACHE	MTBF	POWER USED	COMMENTS		
	WTH.	HGT.	UNFORMAT	FORMATED	CYLS	PRE-COMP	LAND ZONE	S/TK	# PL	RW HD AC	INTER-FACE	CYLS	S/TK		RW HD	RECORD METHOD						AVE. TK/TK	
WDS-3100	3.50	19.9		104.9MB	1990	NONE	AUTO	MZ	1	2	VC	SCSI-2			2300	12ms	5.0ms	32KB	150K	4.5W	4,320 RPM, MZR:2-ZONE		
WDS-3160	3.50	41.3	206.4MB	160.0MB	1021	NONE	AUTO	39	4	8	VC	SCSI-2	(1,7)RLL		1517	16ms	5.0ms	12.0Mb	32KB	110K	13.1W	MiG HEADS	
WDS-3200	3.50	19.9		209.7MB	1990	NONE	AUTO	MZ	2	4	VC	SCSI-2			2300	12ms	5.0ms	32KB	110K	4.5W	4,320 RPM, MZR:2-ZONE		
WDS-380	3.50	41.3	103.5MB	80.0MB	1021	NONE	AUTO	39	2	4	VC	SCSI-2			1517	16ms	5.0ms	32KB	110K	13.1W	MiG HEADS		
WDS-L160	3.50	19.9		171.4MB	1923	NONE	AUTO	44	2	4	VC	SCSI-2			2200	16ms	5.0ms		150K				
WDS-L80	3.50	19.9		85.6MB	1923	NONE	AUTO	44	1	2	VC	SCSI-2			2200	16ms	4.0ms		150K				
0664-CSH	5.25	82.5		4027.0MB	2870	NONE	AUTO		16	32	VC	SCSI-2F			3168	11ms	0.6ms	1MB	375K	23.0W	5,400 RPM		
0664-DSH	5.25	82.5		4027.0MB	2870	NONE	AUTO		16	32	VC	SCSI-2F			3168	11ms	0.6ms	1MB	375K	23.0W	5,400 RPM		
0664-ESH	5.25	82.5		4027.0MB	2870	NONE	AUTO		16	32	VC	SCSI-2FW			3168	11ms	0.6ms	1MB	375K	23.0W	5,400 RPM		
0664-FSH	5.25	82.5		4027.0MB	2870	NONE	AUTO		16	32	VC	SCSI-2FW			3168	11ms	0.6ms	1MB	375K	23.0W	5,400 RPM		
0665-30	5.25	FULL	30.0MB	21.4MB	615	300	616	17	2	4		ST506/412	(1,3)RLL		65ms		5.0Mb						
0665-38	5.25	FULL	38.0MB	30.4MB	733	300	734	17	3	5		ST506/412	(1,3)RLL				5.0Mb						
0671E	5.25		387.0MB							15	VC	ESDI			20ms		10.0Mb	150K					
0671S	5.25		387.0MB							15	VC	SCSI			20ms		10.0Mb	150K					
0681	5.25		1054.0MB							20	VC	SCSI-2			11ms		32.0Mb	150K					
WD-25	5.25	FULL	25.0MB	21.0MB	306	296		17	4	8		ST506/412	(1,3)RLL				5.0Mb						
WD-30	5.25	FULL		30.0MB				17			SM	ST506/412	(1,3)RLL		55ms								
IMI																							
5006	5.25	FULL	6.0MB	5.0MB	306	128		17	1	2		ST506/412	(1,3)RLL				5.0Mb						
5012	5.25	FULL	12.0MB	10.0MB	306	128		17	2	4		ST506/412	(1,3)RLL	78ms			5.0Mb						
5018	5.25	FULL	18.0MB	15.0MB	306	128		17	3	6		ST506/412	(1,3)RLL				5.0Mb						
IMPERIAL TECH.																							
MEGARAM-SCSI	5.25	FULL		320.0MB								SCSI(D)					40.0Mb					SOLID STATE DISK, 16-320 MB	
INTEGRAL																							
1820 MUSTANG	1.80	15mm		21.4MB		NONE	AUTO		1	2	VC	IDE(*)	(2,7)RLL		20ms	8.0ms	32KB	100K	0.5W			*XT/AT, 3,571 RPM	
1841P[A] RANGER	1.80	10.5		42.5MB		NONE	AUTO	MZ	1	2	VC	PCMCIA	(1,7)RLL	2409	118m	8.0ms	17.6Mb	32KB	250K	1.5W			3,571 RPM
1842 STINGRAY	1.80	15mm		42.8MB		NONE	AUTO	MZ	2	3	VC	IDE(*)	(1,7)RLL	2065	18ms	8.0ms	15.0Mb	32KB	100K	2.5W			*XT/AT, 3,571 RPM
1862 MAVERICK	1.80	15mm		64.1MB		NONE	AUTO	MZ	2	3	VC	IDE(AT)	(1,7)RLL	2407	18ms	8.0ms	17.6Mb	32KB	100K	2.5W			3,571 RPM
1862P MAVERICK	1.80	15mm		64.1MB		NONE	AUTO		2			PCMCIA						100K					
1882P[A] COBRA	1.80	12.5		85.0MB		NONE	AUTO	MZ	2	3	VC	PCMCIA	(1,7)RLL	2750	18ms	8.0ms	20.0Mb	32KB	250K	1.5W			3,571 RPM
1885 McKINLEY	1.80	15mm		85.0MB		NONE	AUTO	MZ			VC	IDE(AT)	(1,7)RLL					32KB					3,571 RPM

JASMINE

MODEL NUMBER	--SIZE--		-----CAPACITY-----		-----PHYSICAL-----				--LOGICAL--				RECORD METHOD	TKS /IN.	--ACCESS--		XFER RATE	CACHE	MTBF	POWER USED	COMMENTS				
	WTH.	HGT.	UNFORMAT	FORMATED	PRE-CYLS	LAND COMP	S/ #	RW HD	INTER-FACE	S/ RW	TK HD	AVE.			TK/TK										
DD-180	3.50	HALF		174.0MB					SCSI					20ms		12.0Mb		70K							
JCT																									
100	5.25	HALF		5.0MB			17		ST506/412			(1,3)RLL	*ms		5.0Mb					110ms AVE.ACCESS					
105	5.25	HALF		7.0MB			17		ST506/412			(1,3)RLL	*ms		5.0Mb					110ms AVE.ACCESS					
110	5.25	HALF		14.0MB			17		ST506/412			(1,3)RLL	*ms		5.0Mb					130ms AVE ACCESS					
120	5.25	HALF		20.0MB			17		ST506/412			(1,3)RLL	*ms		5.0Mb					100ms AVE ACCESS					
JVC																									
JD-E2042M	2.50	13mm		42.0MB					IDE					16ms											
JD-E2085M	2.50	19mm		85.0MB					IDE					16ms											
JD-E2825P	2.50	0.8"	25.0MB	21.4MB			1		VC																
JD-E2850P	2.50	0.8"	50.0MB	42.5MB			2		VC					17ms											
JD-F2042M	2.50	10mm		42.0MB					IDE					16ms											
KALOK CORP.																									
KL3100	OCTAGON	3.50	0.8"	120.3MB	105.2MB	820		MZ	3	6	SM	IDE(AT)	979	35	6	(2,7)RLL	944	19ms	5.0ms	14.4Mb	32KB	100K	10.4W	MZR:2-ZONE, 3,662 RPM	
KL3120	OCTAGON	3.50	HALF		120.6MB	820		MZ	3	6	SM	IDE(AT)				(2,7)RLL		19ms		13.5Mb	64KB	100K	10.0W	MZR:2-ZONE, 3,662 RPM	
KL320	OCTAGON	1	3.50	HALF	25.6MB	21.4MB	615	300	17	2	4	SM	ST506/412			(1,3)RLL	814	40ms	10.0m	5.0Mb		44K	10.0W		
KL330	OCTAGON	1	3.50	HALF	38.4MB	32.8MB	616		26	2	4	SM	ST506/412			(2,7)RLL	814	40ms	10.0m	7.5Mb		44K	10.0W		
KL340	OCTAGON	2	3.50	HALF	51.3MB	42.8MB	820		17	3	6	SM	ST506/412			(1,3)RLL	911	25ms		5.0Mb		50K	10.0W		
KL341	OCTAGON	1	3.50	HALF	48.1MB	42.6MB	676		AUTO	31	2	4	SM	SCSI			(2,7)RLL	814	33ms		5.0Mb		40K	10.0W	
KL342	OCTAGON	1	3.50	HALF	48.1MB	42.6MB	676		AUTO	31	2	4	SM	PS/2			(2,7)RLL	814	33ms		5.0Mb		40K	10.0W	
KL343	OCTAGON	1	3.50	HALF	48.1MB	42.6MB	676		AUTO	31	2	4	SM	IDE(AT)			(2,7)RLL	814	33ms		5.8Mb	8KB	100K	10.0W	3,375 RPM
KL360	OCTAGON	2	3.50	HALF	76.9MB	65.5MB	820		26	3	6	SM	ST506/412			(2,7)RLL	911	25ms		7.5Mb		50K	10.0W		
KL381	OCTAGON	2	3.50	HALF	98.4MB	84.7MB	815		34	3	6	SM	SCSI			(2,7)RLL	911	25ms		9.0Mb		50K	10.0W		
KL383	OCTAGON	2	3.50	HALF	98.4MB	84.7MB	815		34	3	6	SM	IDE(AT)			(2,7)RLL	911	25ms		9.0Mb		50K	10.0W		
P5-125A	POINT5	3.50	0.5"		125.8MB	2048		MZ	1	2		IDE(AT)				(1,7)RLL		17ms		26.0Mb	128KB	100K	2.0W	MZR:9-ZONE	
P5-125S	POINT5	3.50	0.5"		125.8MB	2048		MZ	1	2		SCSI-2				(1,7)RLL		17ms		26.0Mb	128KB	100K	2.0W	MZR:9-ZONE	
P5-250A	POINT5	3.50	0.5"		251.9MB	2048		MZ	2	4		IDE(AT)				(1,7)RLL		17ms		26.0Mb	128KB	100K	2.5W	MZR:9-ZONE	
P5-250S	POINT5	3.50	0.5"		251.9MB	2048		MZ	2	4		SCSI-2				(1,7)RLL		17ms		26.0Mb	128KB	100K	2.5W	MZR:9-ZONE	
KYOCERA																									
KC-20A		3.50	HALF		21.5MB	616		AUTO	17	2	4	SM	ST506/412			(1,3)RLL	835	65ms	15.0m	5.0Mb		40K	12.3W		
KC-20B		3.50	HALF		21.4MB	615		AUTO	17	2	4	SM	ST506/412			(1,3)RLL	800	62ms	15.0m	5.0Mb		40K	10.0W		

MODEL NUMBER	--SIZE--		-----CAPACITY-----		-----PHYSICAL-----						-LOGICAL-			RECORD METHOD	TKS /IN.	--ACCESS--		XFER RATE	CACHE	MTBF	POWER USED	COMMENTS
	WTH.	HGT.	UNFORMAT	FORMATED	CYLS	PRE-COMP	LAND ZONE	S/TK	# PL	RW HD	HD AC	INTER-FACE	CYLS			TK	HD					
KC-20C	3.50	HALF	21.4MB	615				17	2	4	SM			(1,3)RLL								
KC-30A	3.50	HALF	32.8MB	616		AUTO	26	2	4	SM	ST506/412			(2,7)RLL	835	65ms	15.0m	7.5Mb		40K	12.5W	
KC-30B	3.50	HALF	32.7MB	615		AUTO	26	2	4	SM	ST506/412			(2,7)RLL	800	62ms	15.0m	7.5Mb		40K	10.7W	
KC-40GA	3.50	HALF	40.5MB	1075				17	1	2	IDE(AT)				1309	28ms		8.0Mb		40K	9.8W	
KC-80C	3.50	HALF	87.0MB	787		AUTO	28	4	8	SM	SCSI			(2,7)RLL		28ms	7.0ms			28K	13.6W	
KC-80GA	3.50	HALF	80.0MB								IDE(AT)			(2,7)RLL		23ms						
KC-80GS	3.50	HALF	83.0MB								SCSI			(2,7)RLL		23ms						
LAPINE																						
3522 TITAN	3.50	HALF	10.0MB	306				17	2	4	ST506/412			(1,3)RLL		65ms		5.0Mb				
3532 TITAN	3.50	HALF	32.0MB	615				26	2	4	ST506/412			(2,7)RLL		65ms		7.5Mb				
LT10	3.50	HALF	10.0MB	615				17	1	2	ST506/412			(1,3)RLL				5.0Mb				
LT100	3.50	HALF	10.0MB								ST506/412					85ms						
LT20	3.50	HALF	20.0MB	615				17	2	4	ST506/412			(1,3)RLL				5.0Mb				
LT200	3.50	HALF	20.0MB	614				17	2	4	ST506/412			(1,3)RLL		65ms		5.0Mb				
LT2000	3.50	HALF	20.0MB	614				17	2	4	ST506/412			(1,3)RLL				5.0Mb				
LT300	3.50	HALF	32.0MB	614				26	2	4	ST506/412			(2,7)RLL				7.5Mb				
LT4000	3.50	HALF	40.0MB								SCSI											
LIBERTY SYSTEMS																						
2040C	2.50	HALF	40.0MB								SCSI				19ms		3.0Mb	32KB	100K			PORTABLE, EXTERNAL
3020C(P)	2.50	HALF	20.0MB								SCSI				19ms		3.0Mb	32KB	100K			SCSI & PARALLEL PORT, PORTABLE
3020CT	2.50	HALF	20.0MB								SCSI				19ms		3.0Mb	32KB	100K			CARTRIDGE, PORTABLE
3040C(P)	2.50	HALF	40.0MB								SCSI				19ms		3.0Mb	32KB	100K			SCSI & PARALLEL PORT, PORTABLE
3040CT	2.50	HALF	40.0MB								SCSI				19ms		3.0Mb	32KB	100K			CARTRIDGE, PORTABLE
50105Q(P)	3.50	HALF	105.0MB								SCSI/PA				12ms		3.0Mb	64KB	60K			SCSI & PARALLEL PORT, PORTABLE
50120C(P)	3.50	HALF	120.0MB								SCSI/PA				19ms		3.0Mb	64KB	60K			CARTRIDGE, SCSI & PARALLEL PORT
5052Q(P)	3.50	HALF	52.0MB								SCSI/PAR				12ms		3.0Mb	64KB	60K			SCSI & PARALLEL PORT, PORTABLE
70105Q	3.50	HALF	105.0MB								SCSI				12ms		3.0Mb	64KB	60K			PARALLEL OPTION, PORTABLE
70170Q	3.50	HALF	170.0MB								SCSI				9ms		3.0Mb	64KB	50K			PARALLEL OPTION, PORTABLE
70210Q	3.50	HALF	210.0MB								SCSI				9ms		3.0Mb	64KB	50K			PARALLEL OPTION, PORTABLE
70340M	3.50	HALF	340.0MB								SCSI				12ms		3.5Mb	32KB	150K			PARALLEL OPTION, PORTABLE
7040Q	3.50	HALF	40.0MB								SCSI				9ms		3.0Mb	64KB	50K			PARALLEL OPTION, PORTABLE



MODEL NUMBER	--SIZE--		-----CAPACITY----		-----PHYSICAL-----							--LOGICAL--			--ACCESS--		XFER RATE	CACHE	MTBF	POWER USED	COMMENTS			
	WTH.	HGT.	UNFORMAT	FORMATED	CYLS	PRE-COMP	LAND ZONE	S/TK	#PL	RWHD	HDAC	INTER-FACE	RECORD METHOD	TKS /IN.	AVE. TK/TK									
70425Q	3.50	HALF		425.0MB								SCSI			10ms	3.0Mb	64KB	50K		PARALLEL OPTION, PORTABLE				
70520Q	3.50	HALF		52.0MB								SCSI			12ms	3.0Mb	64KB	60K		PARALLEL OPTION, PORTABLE				
11544S(P)	5.25			44.0MB								SCSI			20ms	0.6Mb	8KB	30K		CONNS. TO PAR. PORT				
11588S(P)	5.25			88.0MB								SCSI			20ms	0.6Mb	8KB	30K		CONNS. TO PAR. PORT				
22544SD	5.25			2x44.0MB								SCSI			20ms	0.6Mb	8KB	30K		CONNS. TO PAR. PORT				
22588SD	5.25			2x88.0MB								SCSI			20ms	0.6Mb	8KB	30K		CONNS. TO PAR. PORT				
MAGTRON																								
MT-3040A	3.50	HALF		40.2MB					2			IDE(AT)		(2,7)RLL	19ms	10.8Mb								
MT-3080A	3.50	HALF		80.7MB					4			IDE(AT)		(2,7)RLL	17ms	10.8Mb								
MT-3120A	3.50	HALF		130.4MB					4			IDE(AT)		(2,7)RLL	15ms	12.0Mb								
MT-4115E	5.25	HALF	138.0MB	115.0MB	1600	AUTO	35	3	4	VC	ESDI		(2,7)RLL	1460	16ms	5.0ms	10.0Mb	100K	21.0W	DUAL SERVO				
MT-4115S	5.25	HALF	138.0MB	115.0MB	1600	AUTO	35	3	4	VC	SCSI		(2,7)RLL	1460	16ms	5.0ms	10.0Mb	100K	21.0W	DUAL SERVO				
MT-4140E	5.25	HALF	172.0MB	140.0MB	1600	AUTO	35	3	5	VC	ESDI		(2,7)RLL	1460	16ms	5.0ms	10.0Mb	100K	21.0W	DUAL SERVO				
MT-4140S	5.25	HALF	172.0MB	140.0MB	1600	AUTO	35	3	5	VC	SCSI		(2,7)RLL	1460	16ms	5.0ms	10.0Mb	100K	21.0W	DUAL SERVO				
MT-4170E	5.25	HALF	207.0MB	170.0MB	1600	AUTO	35	4	6	VC	ESDI		(2,7)RLL	1460	16ms	5.0ms	10.0Mb	100K	21.0W	DUAL SERVO				
MT-4170S	5.25	HALF	207.0MB	170.0MB	1600	AUTO	35	4	6	VC	SCSI		(2,7)RLL	1460	16ms	5.0ms	10.0Mb	100K	21.0W	DUAL SERVO				
MT-5760E	5.25	HALF	765.0MB	676.8MB	1632	AUTO	54	8	15	VC	ESDI		(1,7)RLL	1400	14ms	3.0ms	15.0Mb	64KB	100K	30.0W				
MT-5760S	5.25	HALF	765.0MB	673.0MB	1632	AUTO	54	8	15	VC	SCSI		(1,7)RLL	1400	14ms	3.0ms	15.0Mb	64KB	100K	30.0W				
MT-6120S	5.25	FULL	1200.0MB									SCSI			13ms									
MAXTOR																								
MXL-105-111	1.80	10.5		105.0MB		NONE	AUTO		2	4		PCMCIA-3												
25084	2.50	10.0		84.0MB		NONE	AUTO		1						12ms	2.5ms		350K		4,247 RPM				
25252	2.50	17.0		252.0MB		NONE	AUTO		3						12ms	2.5ms		350K		4,247 RPM				
2585A APACHE	2.50	0.7"		83.4MB	1092	NONE	AUTO	MZ	2	4	VC	IDE(AT)		(1,7)RLL	1993	15ms	3.0ms	11.0Mb	32KB	150K	2.7W	MZR:4-ZONE, 3,551 RPM		
2585S APACHE	2.50	0.7"		83.4MB	1092	NONE	AUTO	MZ	2	4	VC	SCSI		(1,7)RLL	1993	15ms	3.0ms	11.0Mb	32KB	150K	2.7W	MZR:4-ZONE, 3,551 RPM		
LXT-100AT	3.50	HALF		96.0MB	733	NONE	AUTO	32	4	8	VC	IDE(AT)		(2,7)RLL	1019	27ms	4.0ms	10.0Mb		40K	13.0W			
LXT-100S	3.50	HALF		96.0MB	733	NONE	AUTO	32	4	8	VC	SCSI		(2,7)RLL	1019	27ms	4.0ms	10.0Mb		40K	13.0W			
LXT-200AT	3.50	HALF	234.0MB	201.0MB	1320	NONE	AUTO	32	4	7	VC	IDE(AT)	816	32	15	(1,7)RLL	15ms	3.0ms	12.0Mb		150K	10.0W		
LXT-200S	3.50	HALF	234.0MB	207.0MB	1320	NONE	AUTO	MZ	4	7	VC	SCSI		(1,7)RLL	15ms			12.0Mb		150K	10.0W	MZR:3-ZONE		
LXT-213A	3.50	HALF	248.0MB	212.7MB	1320	NONE	AUTO	MZ	4	7	VC	IDE(AT)	683	38	16	(1,7)RLL	1593	15ms	3.0ms	15.7Mb	32KB	150K	10.0W	MZR:6-ZONE
LXT-213S	3.50	HALF	248.0MB	212.7MB	1320	NONE	AUTO	MZ	4	7	VC	SCSI		(1,7)RLL	1593	15ms	3.0ms	15.7Mb	32KB	150K	10.0W	MZR:6-ZONE		

MODEL NUMBER	--SIZE--		-----CAPACITY-----		-----PHYSICAL-----							-LOGICAL-			TKS /IN.	--ACCESS--		XFER RATE	CACHE	MTBF	POWER USED	COMMENTS		
	WTH.	HGT.	UNFORMAT	FORMATED	CYLS	PRE-COMP	LAND ZONE	S/TK	# PL	RW HD	AC	INTER-FACE	CYLS	S/TK		RW HD	RECORD METHOD						AVE. TK/TK	
LXT-340AT	3.50	HALF	401.0MB	340.0MB	1560	NONE	AUTO	MZ	4	7	VC	IDE(AT)	654	63	16	(1,7)RLL	1613	15ms	3.0ms	16.0Mb	128KB	150K	11.0W	56 BIT ECC, MZR:8-ZONE
LXT-340S	3.50	HALF	401.0MB	340.0MB	1560	NONE	AUTO	MZ	4	7	VC	SCSI				(1,7)RLL	1613	15ms	3.0ms	16.0Mb	128KB	150K	11.0W	56 BIT ECC, MZR:8-ZONE
LXT-340SY	3.50	41.3		340.5MB	1560	NONE	AUTO	MZ	4	7	VC	SCSI-2				(1,7)RLL	1600	13ms	3.0ms	16.9Mb	128KB	150K	11.0W	56 BIT ECC, MZR:8-ZONE
LXT-437A	3.50	HALF	517.0MB	437.0MB	1560	NONE	AUTO	MZ	5	9	VC	IDE(AT)	842	63	16	(1,7)RLL	1600	13ms	3.0ms	16.0Mb	128KB	150K	10.0W	MZR:8-ZONE
LXT-437S	3.50	HALF	517.0MB	437.0MB	1560	NONE	AUTO	MZ	5	9	VC	SCSI				(1,7)RLL	1600	13ms	3.0ms	16.0Mb	128KB	150K	10.0W	MZR:8-ZONE
LXT-50A	3.50	HALF		48.0MB	733	NONE	AUTO	32	2	4	VC	IDE(AT)				(2,7)RLL	1019	27ms	4.0ms	10.0Mb			40K	13.0W
LXT-50S	3.50	HALF		48.0MB	733	NONE	AUTO	32	2	4	VC	SCSI				(2,7)RLL	1019	27ms	4.0ms	10.0Mb			40K	13.0W
LXT-535A	3.50	HALF	613.0MB	535.0MB	1560	NONE	AUTO	MZ	6	11	VC	IDE(AT)				(1,7)RLL	1600	13ms	2.5ms	40.0Mb	128KB	150K	10.0W	MZR:8-ZONE
LXT-535S	3.50	HALF	613.0MB	535.0MB	1560	NONE	AUTO	MZ	6	11	VC	SCSI				(1,7)RLL	1600	13ms	3.0ms	40.0Mb	128KB	150K	10.0W	MZR:8-ZONE
MXT-1240S	3.50	HALF		1240.0MB	2512	NONE	AUTO	MZ	8	15	VC	SCSI-2				(1,7)RLL	2600	9ms	1.5ms	33.7Mb	256KB	300K	13.5W	88BIT ECC, MZR:8-ZONE, 6,300 RPM
MXT-540S	3.50	1.0"		540.0MB		NONE	AUTO				VC	SCSI-2				(1,7)RLL		9ms						6,300 RPM
P0-12S PANTHER	5.25	FULL	1202.0MB	1029.0MB	1632	NONE	AUTO	MZ	8	15	VC	SCSI-2				RLL	1376	13ms	2.0ms	23.0Mb	256KB	100K	26.0W	56 BIT ECC, MZR:4-ZONE
P1-08E PANTHER	5.25	FULL	811.0MB	696.0MB	1778		AUTO	85	5	9	VC	ESDI				RLL	1498	13ms	2.0ms	24.3Mb			100K	26.0W
P1-08S PANTHER	5.25	FULL	811.0MB	696.0MB	1778	NONE	AUTO	85	5	9	VC	SCSI-2				RLL	1498	13ms	2.0ms	24.3Mb	256KB	100K	27.0W	56 BIT ECC
P1-12E PANTHER	5.25	FULL	1234.0MB	1051.0MB	1216		AUTO	85	8	15	VC	ESDI				RLL	1498	13ms	2.0ms	22.2Mb			150K	26.0W
P1-12S PANTHER	5.25	FULL	1171.0MB	1005.0MB	1216	NONE	AUTO	85	10	19	VC	SCSI-2				RLL	1498	11ms	2.0ms	24.3Mb	256KB	100K	27.0W	56 BIT ECC
P1-13E PANTHER	5.25	FULL	1351.0MB	1160.0MB			AUTO		8	15	VC	ESDI				RLL	1498	13ms	2.0ms	24.3Mb			100K	26.0W
P1-16E PANTHER	5.25	FULL	1563.0MB	1331.0MB			AUTO		10	19	VC	ESDI				RLL	1498	13ms	2.0ms	22.2Mb			150K	27.0W
P1-17S PANTHER	5.25	FULL	1759.0MB	1503.0MB	1778	NONE	AUTO	MZ	10	19	VC	SCSI-2				RLL	1498	13ms	2.0ms	24.3Mb	256KB	100K	26.0W	56 BIT ECC, MZR
P2-17E PANTHER	5.25	FULL	1712.0MB	1470.0MB	1778		AUTO	85	10	19	VC	ESDI				RLL	1498	13ms	2.0ms	24.3Mb			100K	27.0W
XT-1065	5.25	FULL	65.0MB	56.0MB	918			17	4	7		ST506/412				(1,3)RLL		28ms		5.0Mb				
XT-1085	5.25	FULL	85.3MB	71.3MB	1024	NONE	AUTO	17	5	8	VC	ST506/412				(1,3)RLL	1070	28ms	4.0ms	5.0Mb			150K	25.0W
XT-1105	5.25	FULL	105.0MB	87.0MB	918			17	6	11		ST506/412				(1,3)RLL		27ms		5.0Mb				
XT-1120R	5.25	FULL	120.0MB	109.1MB	1024			26	4	8		ST506/412				(2,7)RLL		28ms	4.0ms	7.5Mb			70K	26.5W
XT-1140	5.25	FULL	143.4MB	119.9MB	918	NONE	AUTO	17	8	15	VC	ST506/412				(1,3)RLL	1070	27ms	4.0ms	5.0Mb			150K	25.0W
XT-1240R	5.25	FULL	240.0MB	204.5MB	1024			26	8	15		ST506/412				(2,7)RLL		28ms	4.0ms	7.5Mb			70K	26.5W
XT-2085	5.25	FULL	85.0MB	74.0MB	1224			17	4	7		ST506/412				(1,3)RLL		30ms		5.0Mb				
XT-2140	5.25	FULL	140.0MB	117.0MB	1224			17	6	11		ST506/412				(1,3)RLL		30ms		5.0Mb				
XT-2190	5.25	FULL	191.2MB	159.8MB	1224	NONE	AUTO	17	8	15	VC	ST506/412				(1,3)RLL	1070	29ms	4.0ms	5.0Mb			150K	25.0W
XT-3170S	5.25	FULL	170.0MB	146.0MB	1224			48	5	9		SCSI				(2,7)RLL		30ms		15.0Mb				
XT-3280S	5.25	FULL	280.0MB	244.4MB	1224			8	15			SCSI				(2,7)RLL		30ms		15.0Mb				

MODEL NUMBER	--SIZE--		-----CAPACITY-----		-----PHYSICAL-----							-LOGICAL-			ACCESS	XFER RATE	CACHE	MTBF	POWER USED	COMMENTS			
	WTH.	HGT.	UNFORMAT	FORMATED	CYLS	PRE-COMP	LAND ZONE	S/TK	#PL	RWHD	HDAC	INTER-FACE	CYLS	TK							HD	RECORD METHOD	TKS /IN.
XT-3380E	5.25	FULL	380.0MB		1224			36	8	15	ESDI				(2,7)RLL		27ms	15.0Mb				OLD MODELS: 35 S/T (HARD SECT)	
XT-3380S	5.25	FULL	380.0MB		1224			36	8	15	SCSI				(2,7)RLL		27ms	15.0Mb					
XT-4170E	5.25	FULL	179.4MB	157.9MB	1224	NONE	AUTO	36	5	7	VC ESDI				(1,7)RLL	1070	16ms	2.5ms	10.0Mb		150K	27.0W	
XT-4170S	5.25	FULL	179.4MB	157.5MB	1224	NONE	AUTO	36	5	7	VC SCSI				(2,7)RLL	1070	14ms	2.5ms	10.0Mb	45KB	150K	27.0W	48 BIT ECC
XT-4175E	5.25	FULL	175.0MB	157.0MB	1224	NONE	AUTO	36	4	7	VC ESDI				(2,7)RLL		27ms		10.0Mb				
XT-4230E	5.25	FULL	230.7MB	203.0MB	1224	NONE	AUTO	36	5	9	VC ESDI				(1,7)RLL		16ms	2.5ms	10.0Mb		150K	27.0W	
XT-4280S	5.25	FULL	302.7MB	280.0MB	1224	NONE	AUTO	36	6	11	VC SCSI				(2,7)RLL	1070	16ms		10.0Mb				
XT-4380E	5.25	FULL	384.5MB	338.4MB	1224	NONE	AUTO	36	8	15	VC ESDI				(1,7)RLL	1070	16ms	2.5ms	10.0Mb		150K	27.0W	
XT-4380S	5.25	FULL	384.5MB	337.6MB	1224	NONE	AUTO	36	8	15	VC SCSI				(1,7)RLL	1070	16ms	2.5ms	10.0Mb	45KB	150K	27.0W	48 BIT ECC
XT-8380E	5.25	FULL	410.1MB	361.0MB	1632	NONE	AUTO	54	5	8	VC ESDI				(1,7)RLL	1376	15ms	2.5ms	15.0Mb		150K	27.0W	
XT-8380EH	5.25	FULL	410.1MB	361.0MB	1632	NONE	AUTO	54	5	8	VC ESDI				(1,7)RLL	1376	14ms	2.0ms	15.0Mb		150K	27.0W	
XT-8380S	5.25	FULL	410.1MB	360.3MB	1632	NONE	AUTO	54	5	8	VC SCSI				(1,7)RLL	1376	15ms	2.5ms	15.0Mb	45KB	150K	27.0W	48 BIT ECC
XT-8380SH	5.25	FULL	410.1MB	360.3MB	1632	NONE	AUTO	54	5	8	VC SCSI				(1,7)RLL	1376	14ms	2.0ms	15.0Mb	45KB	150K	27.0W	48 BIT ECC
XT-8610E	5.25	FULL	615.3MB	541.4MB	1632	NONE	AUTO	54	7	12	VC ESDI				(1,7)RLL		16ms	3.0ms	15.0Mb		150K	27.0W	
XT-8702S	5.25	FULL	702.0MB	616.7MB	1490	NONE	AUTO	54	8	15	VC SCSI				(1,7)RLL		17ms		15.0Mb		150K	27.0W	
XT-8760E	5.25	FULL	768.9MB	676.8MB	1632	NONE	AUTO	54	8	15	VC ESDI				(1,7)RLL	1376	17ms	2.5ms	15.0Mb		150K	27.0W	
XT-8760EH	5.25	FULL	768.9MB	676.8MB	1632	NONE	AUTO	54	8	15	VC ESDI				(1,7)RLL	1376	14ms	2.0ms	15.0Mb		150K	27.0W	
XT-8760S	5.25	FULL	768.9MB	675.6MB	1632	NONE	AUTO	54	8	15	VC SCSI				(2,7)RLL	1376	17ms	2.5ms	15.0Mb	45KB	150K	27.0W	48 BIT ECC
XT-8760SH	5.25	FULL	768.9MB	675.6MB	1632	NONE	AUTO	54	8	15	VC SCSI				(2,7)RLL	1376	15ms	2.0ms	15.0Mb	45KB	150K	27.0W	48 BIT ECC
XT-8800E	5.25	FULL	800.5MB	694.7MB	1274	NONE	AUTO	71	8	15	VC ESDI				(1,7)RLL	1376	14ms	2.0ms	20.1Mb		150K	27.0W	
MAXTOR COLORADO																							
7040A CHEYENNE	3.50	1.0"	50.0MB	40.7MB	1170	NONE	AUTO	36	1	2	VC IDE(AT)				(1,7)RLL	1394	17ms	6.0ms	10.8Mb	32KB	150K	3.6W	3,703 RPM
7040S CHEYENNE	3.50	1.0"	50.0MB	40.7MB	1155	NONE	AUTO	36	1	2	VC SCSI				(1,7)RLL	1387	17ms	5.0ms	10.8Mb	32KB	150K	4.1W	3,703 RPM
7060A CHEYENNE	3.50	1.0"	76.5MB	65.2MB	1516	NONE	AUTO	42	1	2	VC IDE(AT)				(2,7)RLL	1800	15ms	3.0ms	12.0Mb	64KB	150K	4.5W	3,524 RPM
7060S CHEYENNE	3.50	1.0"	76.5MB	65.2MB	1516	NONE	AUTO	42	1	2	VC SCSI				(2,7)RLL	1800	15ms	3.0ms	12.0Mb	64KB	150K	4.5W	3,524 RPM
7080A CHEYENNE	3.50	1.0"	101.0MB	81.4MB	1170	NONE	AUTO	36	2	4	VC IDE(AT)	981	17	10	(1,7)RLL	1394	17ms	6.0ms	10.8Mb	32KB	150K	3.7W	3,703 RPM
7080S CHEYENNE	3.50	1.0"	101.0MB	80.7MB	1155	NONE	AUTO	36	2	4	VC SCSI				(1,7)RLL	1387	17ms	5.0ms	10.8Mb	32KB	150K	4.5W	3,703 RPM
7130A CHEYENNE	3.50	1.0"	153.1MB	130.4MB	1516	NONE	AUTO	42	2	4	VC IDE(AT)	936	17	16	(2,7)RLL	1800	15ms	3.0ms	12.0Mb	64KB	150K	4.5W	aka: 7120A, 3,524 RPM
7130S CHEYENNE	3.50	1.0"	153.1MB	130.4MB	1516	NONE	AUTO	42	2	4	VC SCSI				(2,7)RLL	1800	15ms	3.0ms	12.0Mb	64KB	150K	4.5W	aka: 7120S, 3,524 RPM
7213A CHEYENNE	3.50	1.0"		212.8MB	1698	NONE	AUTO	MZ	2	4	VC IDE(AT)	683	38	16	(1,7)RLL	1698	15ms	3.0ms	22.6Mb	64KB	150K	3.6W	MZR, 3,551 RPM
7213S CHEYENNE	3.50	1.0"		212.7MB	1698	NONE	AUTO	MZ	2	4	VC SCSI				(1,7)RLL	1698	15ms	3.0ms	22.6Mb	64KB	150K	3.6W	MZR, 3,551 RPM

MODEL NUMBER	--SIZE--		-----CAPACITY-----		-----PHYSICAL-----						-LOGICAL-			RECORD METHOD	TKS /IN.	--ACCESS--		XFER RATE	CACHE	MTBF	POWER USED	COMMENTS
	WTH.	HGT.	UNFORMAT	FORMATED	CYLS	PRE-COMP	LAND ZONE	S/TK	# PL	RW HD	HD AC	INTER-FACE	CYLS			S/TK	RW HD					
8051A	3.50	HALF	51.3MB	42.7MB	745	AUTO	28	2	4	VC	IDE(AT)			(2,7)RLL	1109	28ms	8.0ms	8.0Mb	32KB	150K	8.0W	3,484 RPM
MEGADRIVE																						
P-105	3.50	HALF		105.0MB	1019	AUTO					SCSI			(2,7)RLL	1225	19ms	6.0ms	10.0Mb		50K	10.0W	
P-120	3.50	HALF		120.0MB	1123	AUTO					SCSI			(2,7)RLL	1414	14ms	4.0ms	10.0Mb		50K	11.0W	
P-170	3.50	HALF		170.0MB	1123	AUTO					SCSI			(2,7)RLL	1414	14ms	4.0ms	10.0Mb		50K	11.0W	
P-210	3.50	HALF		210.0MB	1156	AUTO					SCSI			(2,7)RLL	1454	14ms	4.0ms	10.0Mb		50K	12.0W	
P-42	3.50	HALF		42.0MB	834	AUTO					SCSI			(2,7)RLL	1000	19ms	6.0ms	7.5Mb		50K	9.0W	
P-425	3.50	HALF		425.0MB		AUTO					SCSI			(2,7)RLL		9ms				75K		
P-84	3.50	HALF		84.0MB	834	AUTO					SCSI			(2,7)RLL	1000	19ms	6.0ms	10.0Mb		50K	9.0W	
BASE-1(DRV)	5.60	FULL									SCSI										2.0W	
BASE-2(DRV)	7.50	3-HH									SCSI										2.0W	
MEMOREX																						
321				5.0MB	320	128	17	1	2		ST506/412			(1,3)RLL							5.0Mb	
322				10.0MB	320	128	17	2	4		ST506/412			(1,3)RLL							5.0Mb	
323				15.0MB	320	128	17	3	6		ST506/412			(1,3)RLL							5.0Mb	
324				20.0MB	320	128	17	4	8		ST506/412			(1,3)RLL							5.0Mb	
450				10.0MB	612	350	17	1	2		ST506/412			(1,3)RLL							5.0Mb	
512				25.0MB	961	480	17	2	3		ST506/412			(1,3)RLL							5.0Mb	
513				41.0MB	961	480	17	3	5		ST506/412			(1,3)RLL							5.0Mb	
514				58.0MB	961	480	17	4	7		ST506/412			(1,3)RLL							5.0Mb	
MEMTECH																						
PCB902				2.0MB	32		32		4		PC-BUS					.5ms		4.6Mb		5.1W		PLUG-IN SOLID STATE DISK
PCE910				8.0MB	256		16		4		PC-BUS					.5ms		4.6Mb		2.0W		PLUG-IN SOLID STATE DISK
PCF912				4.0MB	128		16		4		PC-BUS					.5ms		4.6Mb		1.5W		PLUG-IN S.S.DISK/FLASH MEMORY
PCF914				4.0MB	128		16		4		PC-BUS					.5ms		4.6Mb		1.5W		PLUG-IN S.S.DISK/FLASH MEMORY
SSD903	3.50	HALF		4.0MB	128		16		4		SCSI					.8ms		4.6Mb		1.8W		SOLID STATE DISK
SSD924	3.50	HALF		24.0MB							SCSI-2									1.3W		SOLID STATE DISK
MICRO SOLUTIONS																						
BACKPACK HD100	3.50	HALF		100.0MB							LPT1											EXT, CONNECTS TO PRINTER PORT
BACKPACK HD200	3.50	HALF		200.0MB							LPT1											EXT, CONNECTS TO PRINTER PORT
BACKPACK HD40	3.50	HALF		40.0MB							LPT1											EXT, CONNECTS TO PRINTER PORT
MICRONET																						

MODEL NUMBER	--SIZE--		-----CAPACITY-----		-----PHYSICAL-----				INTER- FACE	-LOGICAL-			RECORD METHOD	TKS /IN.	--ACCESS--		XFER RATE	CACHE	MTBF	POWER USED	COMMENTS	
	WTH.	HGT.	UNFORMAT	FORMATED	PRE- CYLS	LAND ZONE	S/ TK	# PL		RW HD	HD AC	S/ CYLS			RW TK	HD						AVE.
				40.0MB					SCSI													
				42.0MB					SCSI												REMOVABLE MEDIA	
				50.0MB					SCSI												REMOVABLE MEDIA	
				80.0MB					SCSI													
				100.0MB					SCSI													
				200.0MB					SCSI													
MICROPOLIS																						
1743-5	3.50	HALF		112.0MB	1140	AUTO	MZ	3	5	VC	IDE(AT)			15ms							MZR	
1744-6	3.50	HALF		135.0MB	1140	AUTO	MZ	3	6	VC	IDE(AT)			15ms								MZR
1744-7	3.50	HALF		157.0MB	1140	AUTO	MZ	4	7	VC	IDE(AT)			15ms								MZR
1745-8	3.50	HALF		180.0MB	1140	AUTO	MZ	4	8	VC	IDE(AT)	(2,7)	RLL	15ms	7.5Mb							MZR
1745-9	3.50	HALF		202.0MB	1140	AUTO	MZ	5	9	VC	IDE(AT)	(2,7)	RLL	15ms	7.5Mb							MZR
1773-5	3.50	HALF		112.0MB	1140	AUTO	MZ	3	5	VC	SCSI	(2,7)	RLL	15ms								MZR
1774-6	3.50	HALF		135.0MB	1140	AUTO	MZ	3	6	VC	SCSI	(2,7)	RLL	15ms								MZR
1774-7	3.50	HALF		157.0MB	1140	AUTO	MZ	4	7	VC	SCSI	(2,7)	RLL	15ms								MZR
1775-8	3.50	HALF		180.0MB	1140	AUTO	MZ	4	8	VC	SCSI	(2,7)	RLL	15ms								MZR
1775-9	3.50	HALF		202.0MB	1140	AUTO	MZ	5	9	VC	SCSI	(2,7)	RLL	15ms								MZR
2105-8	3.50	HALF	650.0MB	560.0MB	1760	NONE	AUTO	MZ	5	8	VC	SCSI-2		10ms	1.5ms	32.0Mb		300K	12.0W		MZR, 5,400 RPM	
2105A	3.50	HALF	650.0MB	560.0MB	1760	NONE	AUTO	MZ	5	8	VC	IDE(AT)		10ms	1.5ms	32.0Mb		300K	11.5W		MZR, 5,400 RPM	
2112-15	3.50	HALF	1209.0MB	1050.0MB	1747	NONE	AUTO	MZ	8	15	VC	SCSI-2	RLL	1990	10ms	1.5ms	32.0Mb	256KB	300K	12.0W		MZR, 5,400 RPM
2112A-15	3.50	HALF	1220.0MB	1050.0MB	1760	NONE	AUTO	MZ	8	15	VC	IDE(AT)		10ms	1.5ms	32.0Mb		300K	11.5W		MZR, 5,400 RPM	
1302	5.25	FULL	25.9MB	20.4MB	830	AUTO	17	2	3	VC	ST506/412	(1,3)	RLL	30ms	6.0ms	5.0Mb			20K	29.0W		
1303	5.25	FULL	43.3MB	34.0MB	830	AUTO	17	3	5	VC	ST506/412	(1,3)	RLL	30ms	6.0ms	5.0Mb			20K	29.0W		
1304	5.25	FULL	51.8MB	40.8MB	830	AUTO	17	4	6	VC	ST506/412	(1,3)	RLL	30ms	6.0ms	5.0Mb			20K	29.0W		
1323	5.25	FULL	42.7MB	35.6MB	1024	AUTO	17	3	4	VC	ST506/412	(1,3)	RLL	28ms	6.0ms	5.0Mb			35K	29.0W		
1323A	5.25	FULL	53.3MB	44.5MB	1024	AUTO	17	3	5	VC	ST506/412	(1,3)	RLL	28ms	6.0ms	5.0Mb			35K	29.0W		
1324	5.25	FULL	64.0MB	53.4MB	1024	AUTO	17	4	6	VC	ST506/412	(1,3)	RLL	28ms	6.0ms	5.0Mb			35K	29.0W		
1324A	5.25	FULL	74.7MB	62.3MB	1024	AUTO	17	4	7	VC	ST506/412	(1,3)	RLL	28ms	6.0ms	5.0Mb			35K	29.0W		
1325	5.25	FULL	85.3MB	71.3MB	1024	AUTO	17	5	8	VC	ST506/412	(1,3)	RLL	28ms	6.0ms	5.0Mb			35K	29.0W		
1333	5.25	FULL	42.7MB	35.6MB	1024	AUTO	17	3	4	VC	ST506/412	(1,3)	RLL	28ms	6.0ms	5.0Mb			25K	29.0W		
1333A	5.25	FULL	53.3MB	44.5MB	1024	AUTO	17	3	5	VC	ST506/412	(1,3)	RLL	28ms	6.0ms	5.0Mb			25K	29.0W		

MODEL NUMBER	--SIZE--		-----CAPACITY-----		-----PHYSICAL-----						-LOGICAL-			TKS /IN.	--ACCESS--		XFER RATE	CACHE	MTBF	POWER USED	COMMENTS		
	WTH.	HGT.	UNFORMAT	FORMATED	CYLS	PRE-COMP	LAND ZONE	S/TK	# PL	RW HD AC	INTER-FACE	CYLS	S/TK		RW HD	RECORD METHOD						AVE. TK/TK	
1334	5.25	FULL	64.0MB	53.4MB	1024	AUTO	17	4	6	VC	ST506/412				(1,3)RLL	28ms	6.0ms	5.0Mb		25K	29.0W		
1334A	5.25	FULL	74.7MB	62.3MB	1024	AUTO	17	4	7	VC	ST506/412				(1,3)RLL	28ms	6.0ms	5.0Mb		25K	29.0W		
1335	5.25	FULL	85.3MB	71.3MB	1024	AUTO	17	5	8	VC	ST506/412				(1,3)RLL	28ms	6.0ms	5.0Mb		25K	29.0W		
1352	5.25	FULL		32.0MB	1024	AUTO	36	1	2	VC	ESDI				(2,7)RLL	23ms		10.0Mb					
1352A	5.25	FULL		41.0MB	1024	AUTO	36	2	3	VC	ESDI				(2,7)RLL	23ms		10.0Mb					
1353	5.25	FULL	85.3MB	75.4MB	1024	AUTO	36	3	4	VC	ESDI				(2,7)RLL	23ms	5.0ms	10.0Mb		150K	32.0W		
1353A	5.25	FULL	106.6MB	94.2MB	1024	AUTO	36	3	5	VC	ESDI				(2,7)RLL	23ms	5.0ms	10.0Mb		150K	32.0W		
1354	5.25	FULL	127.9MB	113.1MB	1024	AUTO	36	4	6	VC	ESDI				(2,7)RLL	23ms	5.0ms	10.0Mb		150K	32.0W		
1354A	5.25	FULL	149.3MB	131.9MB	1024	AUTO	36	4	7	VC	ESDI				(2,7)RLL	23ms	5.0ms	10.0Mb		150K	32.0W		
1355	5.25	FULL	170.6MB	150.8MB	1024	AUTO	36	5	8	VC	ESDI				(2,7)RLL	1055	23ms	5.0ms	10.0Mb		150K	32.0W	
1373	5.25	FULL	85.3MB	72.9MB	1024	AUTO	36	3	4	VC	SCSI				(2,7)RLL	23ms	5.0ms	12.8Mb	16KB	30K	35.0W		
1373A	5.25	FULL	106.6MB	91.2MB	1024	AUTO	36	3	5	VC	SCSI				(2,7)RLL	23ms	5.0ms	12.8Mb	16KB	30K	35.0W		
1374	5.25	FULL	127.9MB	109.4MB	1024	AUTO	36	4	6	VC	SCSI				(2,7)RLL	23ms	5.0ms	12.8Mb	16KB	30K	35.0W		
1374A	5.25	FULL	149.3MB	127.7MB	1024	AUTO	36	4	7	VC	SCSI				(2,7)RLL	23ms	5.0ms	12.8Mb	16KB	30K	35.0W		
1375	5.25	FULL	170.6MB	145.9MB	1024	AUTO	36	5	8	VC	SCSI				(2,7)RLL	1055	23ms	5.0ms	12.8Mb	16KB	30K	35.0W	
1516-10S	5.25	FULL		678.0MB	1840	AUTO	72	5	10	VC	ESDI				(2,7)RLL	14ms		20.0Mb					
1517-13	5.25	FULL		922.0MB	1925	AUTO	72	7	13	VC	ESDI				(2,7)RLL	14ms		20.0Mb					
1518-14	5.25	FULL	1120.0MB	993.0MB	1925	AUTO	72	7	14	VC	ESDI				(2,7)RLL	14ms		20.0Mb					
1518-15	5.25	FULL	1534.0MB	1341.0MB	2104	AUTO	83	8	15	VC	ESDI				(2,7)RLL	15ms	4.0ms	23.3Mb		150K	24.0W		
1528-15 [D]	5.25	FULL	1535.0MB	1342.0MB	2100	AUTO	84	8	15	VC	SCSI-2				(2,7)RLL	15ms	4.0ms	23.3Mb	256KB	150K	24.0W	48 BIT ECC	
1538-15	5.25	FULL	1043.0MB	910.0MB	1669	AUTO	71	8	15	VC	ESDI				(2,7)RLL	15ms	4.0ms	23.3Mb		150K	24.0W		
1548-15 [D] [HS]	5.25	FULL	2000.0MB	1735.0MB	2099	AUTO	MZ	8	15	VC	SCSI-2F					14ms	2.5ms	32.0Mb	256KB	150K	24.0W	48 BIT ECC, FAST SCSI-2	
1556-11	5.25	FULL	280.0MB	248.0MB	1224	AUTO	36	6	11	VC	ESDI				(2,7)RLL	18ms	4.0ms	10.0Mb		30K	29.0W		
1557-12	5.25	FULL	305.0MB	270.0MB	1224	AUTO	36	7	12	VC	ESDI				(2,7)RLL	18ms	4.0ms	10.0Mb		30K	29.0W		
1557-13	5.25	FULL	331.0MB	293.0MB	1224	AUTO	36	7	13	VC	ESDI				(2,7)RLL	18ms	4.0ms	10.0Mb		30K	29.0W		
1558-14	5.25	FULL	356.0MB	315.0MB	1224	AUTO	36	8	14	VC	ESDI				(2,7)RLL	1075	18ms	4.0ms	10.0Mb		30K	29.0W	
1558-15	5.25	FULL	382.3MB	338.1MB	1224	AUTO	36	8	15	VC	ESDI				(2,7)RLL	1075	18ms	4.0ms	10.0Mb		150K	32.0W	
1566-11	5.25	FULL	561.0MB	496.0MB	1632	AUTO	54	6	11	VC	ESDI				(2,7)RLL	16ms	4.0ms	15.0Mb		30K	29.0W		
1567-12	5.25	FULL	612.0MB	541.0MB	1632	AUTO	54	7	12	VC	ESDI				(2,7)RLL	16ms	4.0ms	15.0Mb		30K	29.0W		
1567-13	5.25	FULL	663.0MB	586.0MB	1632	AUTO	54	7	13	VC	ESDI				(2,7)RLL	16ms	4.0ms	15.0Mb		30K	29.0W		
1568-14	5.25	FULL	714.0MB	631.0MB	1632	AUTO	54	8	14	VC	ESDI				(2,7)RLL	16ms	4.0ms	15.0Mb		30K	29.0W		

MODEL NUMBER	--SIZE--		-----CAPACITY-----		-----PHYSICAL-----							--LOGICAL--			XFER RATE	CACHE	MTBF	POWER USED	COMMENTS			
	WTH.	HGT.	UNFORMAT	FORMATED	CYLS	PRE-COMP	LAND ZONE	S/TK	# PL	RW HD AC	INTER-FACE	CYLS	S/TK	RW HD						RECORD METHOD	TKS /IN.	---ACCESS---
1568-15	5.25	FULL	765.0MB	676.0MB	1632	AUTO	54	8	15	VC	ESDI			(2,7)RLL	16ms	4.0ms	15.0Mb		150K	29.0W		
1576-11	5.25	FULL	280.0MB	243.0MB	1220	AUTO	36	6	11	VC	SCSI			(2,7)RLL	1075	18ms	4.0ms	10.0Mb	64KB	30K	31.0W	
1577-12	5.25	FULL	305.0MB	266.0MB	1220	AUTO	36	7	12	VC	SCSI			(2,7)RLL	1075	18ms	4.0ms	10.0Mb	64KB	30K	31.0W	
1577-13	5.25	FULL	331.0MB	287.0MB	1220	AUTO	36	7	13	VC	SCSI			(2,7)RLL		18ms	4.0ms	10.0Mb	64KB	30K	31. W	
1578-14	5.25	FULL	356.0MB	310.0MB	1220	AUTO	36	8	14	VC	SCSI			(2,7)RLL	1075	18ms	4.0ms	10.0Mb	64KB	30K	31.0W	
1578-15 [D]	5.25	FULL	382.3MB	331.7MB	1224	AUTO	36	8	15	VC	SCSI			(2,7)RLL		16ms	4.0ms	10.0Mb	64KB	150K	32.0W	
1586-11	5.25	FULL	561.0MB	490.0MB	1628	AUTO	54	6	11	VC	SCSI			(2,7)RLL		16ms	2.0ms	15.0Mb		30K	31.0W	
1587-12	5.25	FULL	612.0MB	535.0MB	1628	AUTO	54	7	12	VC	SCSI			(2,7)RLL		16ms	2.0ms	15.0Mb		30K	31.0W	
1587-13	5.25	FULL	663.0MB	579.0MB	1628	AUTO	54	7	13	VC	SCSI			(2,7)RLL		16ms	2.0ms	15.0Mb		30K	31.0W	
1588-14	5.25	FULL	714.0MB	624.0MB	1628	AUTO	54	8	14	VC	SCSI			(2,7)RLL		16ms	2.0ms	15.0Mb		30K	31.0W	
1588-15 [D] [HS]	5.25	FULL	764.9MB	667.6MB	1632	AUTO	54	8	15	VC	SCSI1/2			(2,7)RLL		16ms	2.0ms	15.0Mb	64KB	150K	24.0W	48 BIT ECC, OPT. 256KB CACHE
1596-10S	5.25	FULL		668.0MB	1834	AUTO	72	5	10	VC	SCSI			(2,7)RLL		14ms						
1597-13	5.25	FULL		909.0MB	1919	AUTO	72	7	13	VC	SCSI			(2,7)RLL		14ms						
1598-14	5.25	FULL		979.0MB	1919	AUTO	72	7	14	VC	SCSI			(2,7)RLL		14ms						
1598-15 [D] [HS]	5.25	FULL	1203.0MB	1034.6MB	1919	AUTO	72	8	15	VC	SCSI-2			(2,7)RLL		14ms	4.0ms	32.0Mb	256KB	150K	30.0W	
1624-7	5.25	HALF	765.0MB	668.0MB	2112	AUTO	MZ	4	7	VC	SCSI-2F					16ms	2.5ms	26.0Mb	256KB	150K	14.0W	48 BIT ECC, FAST SCSI-2
1653-4	5.25	HALF	104.0MB	92.0MB	1249	AUTO	36	3	4	VC	ESDI			(2,7)RLL		16ms	4.0ms	10.0Mb		150K	14.0W	
1653-5	5.25	HALF	130.0MB	115.0MB	1249	AUTO	36	3	5	VC	ESDI			(2,7)RLL		16ms	4.0ms	10.0Mb		150K	14.0W	
1654-6	5.25	HALF	156.1MB	138.0MB	1249	AUTO	36	4	6	VC	ESDI			(2,7)RLL	1100	16ms	4.0ms	10.0Mb		150K	14.0W	
1654-7	5.25	HALF	182.1MB	161.0MB	1249	AUTO	36	4	7	VC	ESDI			(2,7)RLL	1100	16ms	4.0ms	10.0Mb		150K	14.0W	
1663-4	5.25	HALF		197.0MB	1780	AUTO		2	4	VC	ESDI			(2,7)RLL		14ms		15.0Mb		150K	15.0W	
1663-5	5.25	HALF		246.0MB	1780	AUTO		3	5	VC	ESDI			(2,7)RLL		14ms		15.0Mb		150K	15.0W	
1664-6	5.25	HALF		295.0MB	1780	AUTO		3	6	VC	ESDI			(2,7)RLL		14ms		15.0Mb		150K	15.0W	
1664-7	5.25	HALF	389.3MB	344.4MB	1780	AUTO	54	4	7	VC	ESDI			(2,7)RLL		14ms	4.0ms	15.0Mb		150K	14.0W	
1673-4	5.25	HALF	104.0MB	90.3MB	1249	AUTO	36	3	4	VC	SCSI			(2,7)RLL		16ms	4.0ms	10.0Mb		150K	15.0W	
1673-5	5.25	HALF	130.0MB	112.6MB	1249	AUTO	36	3	5	VC	SCSI			(2,7)RLL		16ms	4.0ms	10.0Mb		150K	15.0W	
1674-6	5.25	HALF	156.1MB	135.5MB	1249	AUTO	36	4	6	VC	SCSI			(2,7)RLL	1100	16ms	4.0ms	10.0Mb		150K	15.0W	
1674-7 [HS]	5.25	HALF	182.1MB	157.8MB	1249	AUTO	36	4	7	VC	SCSI			(2,7)RLL	1100	16ms	4.0ms	10.0Mb	64KB	150K	15.0W	
1683-4	5.25	HALF		193.0MB	1780	AUTO	54	2	4	VC	SCSI			(2,7)RLL		14ms		12.0Mb		150K	15.0W	
1683-5	5.25	HALF		242.0MB	1780	AUTO	54	3	5	VC	SCSI			(2,7)RLL		14ms		12.0Mb		150K	15.0W	
1684-6	5.25	HALF		291.0MB	1780	AUTO	54	3	6	VC	SCSI			(2,7)RLL		14ms		12.0Mb		150K	15.0W	

MODEL NUMBER	--SIZE--		-----CAPACITY-----		-----PHYSICAL-----						-LOGICAL-			TKS /IN.	--ACCESS--		XFER RATE	CACHE	MTBF	POWER USED	COMMENTS
	WTH.	HGT.	UNFORMAT	FORMATED	PRE-COMP	LAND ZONE	S/TK	# PL	RW HD	AC	INTER-FACE	S/TK	RW HD		RECORD METHOD	AVE.					
1684-7[HS]	5.25	HALF	389.3MB	339.6MB	1780	AUTO	54	4	7	VC	SCSI			(2,7)RLL	14ms	4.0ms	15.0Mb	64KB	150K	14.8W	48 BIT ECC, MAC/PC
1908-15[D][HS]	5.25	FULL	1600.0MB	1408.0MB	2112	AUTO	MZ	8	15	VC	SCSI-2F				12ms	2.5ms	35.0Mb	256KB	150K	24.0W	48BIT ECC, 5,400 RPM, MZR
1924-21	5.25	FULL	2440.0MB	2100.0MB	2280	AUTO	MZ	11	21	VC	SCSI-2				12ms	2.0ms	35.0Mb		250K	30.0W	MZR, 5,400 RPM
1924[D][HS]	5.25	FULL	2400.0MB	2070.0MB		AUTO		8	15	VC	SCSI-2F				12ms			256KB	150K	30.0W	48BIT ECC, 5,400 RPM, FAST SCSI
1936[D,WF]	5.25	FULL	3600.0MB							VC	SCSI-2F			12ms				256KB			[D]DIFF, [FW]FAST/WIDE, 5400 RPM
MICROSCIENCE																					
4050	3.50	HALF		44.5MB	1024	AUTO	17	3	5	VC	ST506/412			(1,3)RLL	1250	18ms		5.0Mb		36K	10.0W
4060	3.50	HALF		66.8MB	1024	AUTO		3	5	VC	ST506/412			(2,7)RLL	1250	18ms		7.5Mb		36K	10.0W
4070	3.50	HALF		62.3MB	1024	AUTO	17	4	7	VC	ST506/412			(1,3)RLL	1250	18ms		5.0Mb		36K	11.0W
4090	3.50	HALF	111.0MB	93.4MB	1024	AUTO		4	7	VC	ST506/412			(2,7)RLL	1250	18ms		7.5Mb		36K	11.0W
5040	3.50	HALF		47.2MB		AUTO			3	VC	ESDI			(2,7)RLL		18ms					
5100	3.50	HALF	140.0MB	110.3MB	855	AUTO	36	4	7	VC	ESDI			(2,7)RLL	1250	18ms	4.0ms	10.0Mb		60K	10.0W
5100-20	3.50	HALF		120.0MB	960	AUTO	35	4	7	VC	ESDI			(2,7)RLL		18ms	4.0ms	10.0Mb		60K	
6100	3.50	HALF	140.0MB	107.0MB	855	AUTO	36	4	7	VC	SCSI			(2,7)RLL	1250	18ms	4.0ms	10.0Mb		60K	11.0W
6100-20	3.50	HALF		120.0MB	960	AUTO	35	4	7	VC	SCSI			(2,7)RLL		18ms	4.0ms	10.0Mb		60K	
7040	3.50	HALF		47.2MB	855	AUTO	36	2	3	VC	IDE(AT)			(2,7)RLL		18ms		10.0Mb			
7100	3.50	HALF	124.6MB	107.3MB	855	AUTO	35	4	7	VC	IDE(AT)			(2,7)RLL	1250	18ms	4.0ms	10.0Mb	32KB	60K	11.0W
7100-20	3.50	HALF	139.9MB	120.4MB	960	AUTO	35	4	7	VC	IDE(AT)			(2,7)RLL	1250	18ms	4.0ms	10.0Mb	32KB	60K	11.0W
7200	3.50	HALF	232.7MB	201.4MB	1277	AUTO	44	4	7	VC	IDE(AT)			(2,7)RLL	1561	18ms	4.0ms	12.5Mb	32KB	60K	11.0W
8040	3.50	HALF		42.0MB		AUTO			2	VC	IDE(AT)			(2,7)RLL		18ms					
21200	5.25	FULL	1200.0MB	1062.2MB	1921	AUTO	72	8	15	VC	ESDI			RLL	1678	13ms	3.0ms	20.0Mb	64KB	100K	30.0W
2777	5.25	FULL	777.0MB	687.6MB	1658	AUTO	54	8	15	VC	ESDI			RLL	1499	14ms	3.0ms	15.0Mb	64KB	100K	30.0W
31200	5.25	FULL	1200.0MB	1062.2MB	1921	AUTO	72	8	15	VC	SCSI-2			RLL	1678	13ms	3.0ms	20.0Mb	64KB	100K	30.0W
3777	5.25	FULL	777.0MB	687.6MB	1658	AUTO	54	8	15	VC	SCSI-2			RLL	1499	14ms	3.0ms	15.0Mb	64KB	100K	30.0W
FH-2414	5.25	FULL	414.0MB	366.0MB		AUTO		5		VC	ESDI				14ms	3.0ms	15.0Mb				
FH-2777E	5.25	FULL	777.0MB			AUTO				VC	ESDI			(2,7)RLL		14ms		15.0Mb		50K	
FH-2777S	5.25	FULL	777.0MB			AUTO				VC	SCSI			(2,7)RLL		14ms		15.0Mb		50K	
FH-31200S	5.25	FULL	1200.0MB	1060.0MB		AUTO				VC	SCSI				14ms						
FH-3414	5.25	FULL	414.0MB	366.0MB		AUTO		5		VC	SCSI				14ms	3.0ms	15.0Mb				
FH-3777E	5.25	FULL	1200.0MB			AUTO				VC	ESDI			(2,7)RLL		14ms		15.0Mb		50K	
FH-3777S	5.25	FULL	1200.0MB			AUTO				VC	SCSI			(2,7)RLL		14ms		15.0Mb		50K	



MODEL NUMBER	--SIZE--		-----CAPACITY-----		-----PHYSICAL-----							-LOGICAL-			TKS /IN.	--ACCESS--		XFER RATE	CACHE	MTBF	POWER USED	COMMENTS		
	WTH.	HGT.	UNFORMAT	FORMATED	CYLS	PRE-COMP	LAND ZONE	S/TK	#PL	RW/HD	HD/AC	INTER-FACE	CYLS	S/TK		RW/HD	RECORD METHOD						AVE. TK/TK	TK/TK
HH-1050	5.25	HALF	50.0MB	44.6MB	1024	AUTO	17	3	5	VC	ST506/412		(1,3)	RLL	960	28ms	5.0Mb		99K	14.0W				
HH-1060	5.25	HALF	68.2MB	65.5MB	1024			26	3	5	ST506/412		(2,7)	RLL	960	28ms	7.5Mb		99K	14.0W				
HH-1075	5.25	HALF	75.0MB	62.4MB	1024	AUTO	17	4	7	VC	ST506/412		(1,3)	RLL		28ms	5.0Mb							
HH-1080	5.25	HALF	80.0MB	65.5MB	1024	AUTO	26	3	5	VC	ST506/412		(2,7)	RLL		28ms	7.5Mb							
HH-1090	5.25	HALF	90.0MB	80.1MB	1314	AUTO	17	4	7	VC	ST506/412		(1,3)	RLL	1250	28ms	5.0Mb		40K	11.0W				
HH-1095	5.25	HALF	95.4MB		1024	AUTO	26	4	7	VC	ST506/412		(2,7)	RLL		28ms	7.5Mb							
HH-1120	5.25	HALF	122.4MB	95.4MB	1314	AUTO	26	4	7	VC	ST506/412		(2,7)	RLL	1250	28ms	7.5Mb		40K	11.0W				
HH-2085	5.25	HALF									ESDI		(2,7)	RLL		28ms	10.0Mb							
HH-2120	5.25	HALF	149.3MB	121.1MB	1024	AUTO	33	4	7	VC	ESDI		(2,7)	RLL	1250	28ms	10.0Mb		40K	12.0W				
HH-2160	5.25	HALF		160.1MB	1276	AUTO		4	7	VC	ESDI		(2,7)	RLL	1250	28ms	10.0Mb		40K	12.0W				
HH-312	5.25	HALF		10.0MB	306			17	2	4	ST506/412		(1,3)	RLL			5.0Mb							
HH-3120	5.25	HALF		121.1MB	1314	AUTO	26	3	5	VC	SCSI		(2,7)	RLL	1250	28ms	7.5Mb		40K	12.0W				
HH-315	5.25	HALF		10.0MB	306			17	2	4	ST506/412		(1,3)	RLL			5.0Mb							
HH-3160	5.25	HALF		169.5MB	1314	AUTO		4	7	VC	SCSI		(2,7)	RLL	1250	28ms	10.0Mb		40K	12.0W				
HH-325	5.25	HALF	25.0MB	21.0MB	612			17	2	4	ST506/412		(1,3)	RLL		80ms	5.0Mb							
HH-330	5.25	HALF		32.0MB	612			26	2	4	ST506/412		(2,7)	RLL		99ms	7.5Mb							
HH-612	5.25	HALF	12.0MB	10.9MB	306			17	2	4	ST506/412		(1,3)	RLL		85ms	5.0Mb							
HH-625	5.25	HALF	25.0MB	21.0MB	612			17	2	4	ST506/412		(1,3)	RLL			5.0Mb							
HH-712	5.25	HALF	12.0MB	10.0MB	612			17	1	2	ST506/412		(1,3)	RLL		*ms	5.0Mb				* 105ms			
HH-725	5.25	HALF	25.0MB	21.0MB	612			17	2	4	ST506/412		(1,3)	RLL		*ms	5.0Mb					* 105ms		
HH-738	5.25	HALF		32.0MB	612			26	2	4	ST506/412		(2,7)	RLL		*ms	7.5Mb					* 105ms		
HH-825	5.25	HALF	25.0MB	21.0MB	615			17	2	4	ST506/412		(1,3)	RLL		65ms	5.0Mb							
HH-830	5.25	HALF		38.0MB	615			26	2	4	ST506/412		(2,7)	RLL		65ms	7.5Mb							
MINISCRIBE																								
MS7040A	3.50	1.0"		42.1MB	1170	NONE	AUTO	36	1	2	VC IDE(AT)		(1,7)	RLL	1394	19ms	4.0ms	10.8Mb	32KB	150K	3.6W	3,703 RPM		
MS7040S	3.50	1.0"		40.0MB	1155		AUTO	36	1	2	VC SCSI		(1,7)	RLL	1387	17ms	5.0ms	10.8Mb	32KB	150K	4.1W	3,703 RPM		
MS7080A	3.50	1.0"	101.0MB	81.4MB	1170	NONE	AUTO	36	2	4	VC IDE(AT)	981	17	10	(1,7)	RLL	1394	19ms	4.0ms	10.8Mb	32KB	150K	3.7W	3,703 RPM
MS7080S	3.50	1.0"	101.0MB	80.7MB	1155	NONE	AUTO	36	2	4	VC SCSI				(1,7)	RLL	1387	17ms	5.0ms	10.8Mb	32KB	150K	4.5W	3,703 RPM
MS7120A	3.50	1.0"	153.1MB	130.4MB	1516	NONE	AUTO	42	2	4	VC IED(AT)	936	17	16	(1,7)	RLL		15ms	12.0Mb	64KB	150K	4.5W	3,703 RPM	
MS8048	3.50	HALF	48.0MB	40.0MB			AUTO				SCSI						30ms							
MS8051A	3.50	HALF	51.3MB	42.7MB	745	NONE	AUTO	28	2	4	VC IDE(AT)		(2,7)	RLL	1109	28ms	8.0ms	8.0Mb	32KB	150K	8.0W	3,484 RPM		

MODEL NUMBER	--SIZE--		-----CAPACITY-----		-----PHYSICAL-----						-LOGICAL-		RECORD METHOD	TKS /IN.	--ACCESS--		XFER RATE	CACHE	MTBF	POWER USED	COMMENTS
	WTH.	HGT.	UNFORMAT	FORMATED	CYLS	PRE- COMP	LAND ZONE	S/ TK	# PL	RW HD	HD AC	INTER- FACE			S/ CYLS	RW TK					
MS8051S	3.50	HALF	51.3MB	45.1MB	793	NONE	AUTO	28	2	4	VC	SCSI	(2,7)RLL	1109	28ms	8.0ms	8.0Mb	32KB	150K	8.0W	3,484 RPM
MS8212	3.50	HALF	12.0MB	10.0MB	615	128		17	1	2	SM	ST506/412	(1,3)RLL		68ms		5.0Mb				
MS8225	3.50	HALF	24.0MB	20.3MB	771	128	810	26	1	2	SM	ST506/412	(2,7)RLL	898	68ms		7.5Mb	20K		12.0W	
MS8225A1	3.50	HALF	25.0MB	21.4MB	747	NONE	810	28	1	2	SM	IDE(AT)	(2,7)RLL		28ms		8.0Mb				
MS8225AT	3.50	HALF	25.0MB	21.4MB	747	NONE	810	28	1	2	SM	IDE(AT)	(2,7)RLL	898	40ms	12.0m	7.5Mb	30K		12.0W	
MS8225S	3.50	HALF	25.0MB	20.0MB	804			26	1	2	SM	SCSI	(2,7)RLL		68ms		7.5Mb				
MS8225XT	3.50	HALF	25.2MB	21.4MB	805	NONE	820	26	1	2	SM	IDE(XT)	(2,7)RLL	898	68ms	15.0m	7.5Mb	30K		12.0W	
MS8412	3.50	HALF	12.0MB	10.6MB	306	128	336	17	2	4	SM	ST506/412	(1,3)RLL		50ms		5.0Mb				
MS8425	3.50	HALF	25.6MB	21.4MB	615	128	664	17	2	4	SM	ST506/412	(1,3)RLL	804	68ms		5.0Mb			9.9W	
MS8425F	3.50	HALF	25.6MB	21.4MB	615	128	664	17	2	4	SM	ST506/412	(1,3)RLL	804	40ms		5.0Mb			12.5W	
MS8425S	3.50	HALF	25.5MB	21.3MB	615	128	664	17	2	4	SM	SCSI	(1,3)RLL	804	68ms		5.0Mb			12.5W	
MS8425XT	3.50	HALF	25.6MB	21.4MB	615	128	664	17	2	4	SM	IDE(XT)	(1,3)RLL	804	68ms	15.0m	5.0Mb	20K		12.0W	
MS8434F	3.50	HALF		32.0MB	615	128	664	26	2	4	SM	ST506/412	(2,7)RLL		40ms		7.5Mb				
MS8438	3.50	HALF	38.4MB	32.7MB	615	128	664	26	2	4	SM	ST506/412	(2,7)RLL	804	68ms		7.5Mb			9.9W	
MS8438F	3.50	HALF	38.4MB	32.7MB	615	128	664	26	2	4	SM	ST506/412	(2,7)RLL	804	40ms		7.5Mb				
MS8438XT	3.50	HALF	38.0MB	32.7MB	615	128	664	26	2	4	SM	IDE(XT)	(2,7)RLL	804	68ms		7.5Mb				
MS8450	3.50	HALF	50.0MB	41.1MB	771	128	810	26	2	4	SM	ST506/412	(2,7)RLL		45ms		7.5Mb				
MS8450A	3.50	HALF	49.6MB	42.7MB	745	NONE	810	28	2	4	SM	IDE(AT)	(2,7)RLL	898	40ms	12.0m	8.0Mb	30K		12.0W	
MS8450S	3.50	HALF		40.0MB	809	128	820	26	2	4	SM	SCSI	(2,7)RLL		68ms		7.5Mb				
MS8450XT	3.50	HALF	50.3MB	42.9MB	805	128	820	26	2	4	SM	IDE(XT)	(2,7)RLL	898	68ms		7.5Mb	30K		12.0W	
MS1006	5.25	FULL	6.3MB	5.1MB	306	128	336	17	1	2	SM	ST506/412	(1,3)RLL		*ms	17.0m	5.0Mb	8K		23.0W	*179ms AVE ACCESS
MS1012	5.25	FULL	12.4MB	10.1MB	306	128	336	17	2	4	SM	ST506/412	(1,3)RLL		*ms	17.0m	5.0Mb	8K		23.0W	*179ms AVE ACCESS
MS2006	5.25	FULL	6.3MB	5.1MB	306	128	336	17	1	2	SM	ST506/412	(1,3)RLL	402	93ms	18.0m	5.0Mb	10K		23.0W	
MS2012	5.25	FULL	12.4MB	10.1MB	306	128	336	17	2	4	SM	ST506/412	(1,3)RLL	402	85ms	18.0m	5.0Mb	10K		23.0W	
MS3012	5.25	HALF	12.4MB	10.1MB	612	128	656	17	1	2	SM	ST506/412	(1,3)RLL	588	*ms	18.0m	5.0Mb	10K		18.0W	*155ms AVE ACCESS
MS3053	5.25	HALF	53.3MB	44.6MB	1024	512	AUTO	17	3	5	SM	ST506/412	(1,3)RLL	1033	25ms	5.0ms	5.0Mb			12.4W	
MS3085	5.25	HALF	85.3MB	71.3MB	1170	512	AUTO	17	4	7		ST506/412	(1,3)RLL	1100	22ms		5.0Mb	35K		13.5W	
MS3085E	5.25	HALF	83.0MB	72.0MB	1270	512			2	3	ESDI		(2,7)RLL	1193	17ms		10.6Mb	35K		15.0W	
MS3085S	5.25	HALF	83.0MB	72.0MB	1255	512			2	3	SCSI			1193	17ms		10.6Mb	35K		17. W	
MS3130E	5.25	HALF	130.2MB	109.9MB	1250	NONE	AUTO	36	3	5	ESDI		(2,7)RLL	1135	17ms	3.5ms	10.0Mb	35K		15.0W	
MS3130S	5.25	HALF	130.0MB	115.0MB	1250	NONE	AUTO	35	3	5	SCSI		(2,7)RLL		17ms		12.0Mb				

MODEL NUMBER	--SIZE--		-----CAPACITY-----		-----PHYSICAL-----						--LOGICAL--			RECORD METHOD	TKS /IN.	--ACCESS--		XFER RATE	CACHE	MTBF	POWER USED	COMMENTS
	WTH.	HGT.	UNFORMAT	FORMATED	CYLS	PRE-COMP	LAND ZONE	S/TK	# PL	RW HD AC	INTER-FACE	S/TK	RW HD			AVE. TK/TK						
MS3180E	5.25	HALF	182.3MB	153.8MB	1250	NONE	AUTO	36	4	7	VC	ESDI	(2,7)RLL	1135	17ms	3.5ms	10.0Mb		35K	15.0W		
MS3180S	5.25	HALF	182.0MB	161.9MB	1250	NONE	AUTO	36	4	7	VC	SCSI	(2,7)RLL	1193	17ms		12.0Mb		35K	20.0W		
MS3180SM	5.25	HALF	182.0MB	160.0MB	1250	NONE	AUTO	36	4	7	VC	SCSI(M)	(2,7)RLL	1193	17ms		12.0Mb		35K	20.0W	MACINTOSH	
MS3212	5.25	HALF	12.4MB	10.2MB	612	128	656	17	1	2	SM	ST506/412	(1,3)RLL	588	85ms	15.0m	5.0Mb		11K	13.0W		
MS3212+	5.25	HALF	12.4MB	10.2MB	612	128	656	17	1	2	SM	ST506/412	(1,3)RLL	588	53ms		5.0Mb					
MS3412	5.25	HALF	12.4MB	10.2MB	306	128	336	17	2	4	SM	ST506/412	(1,3)RLL	588	60ms	15.0m	5.0Mb		11K	13.0W		
MS3425	5.25	HALF	25.0MB	20.4MB	615	128	656	17	2	4	SM	ST506/412	(1,3)RLL	588	85ms	15.0m	5.0Mb		20K	14.5W		
MS3425+	5.25	HALF	25.0MB	21.4MB	615	128	656	17	2	4	SM	ST506/412	(1,3)RLL	588	53ms	15.0m	5.0Mb		20K	18.6W	OLD MODELS HAVE 65ms ACCESS	
MS3438	5.25	HALF	37.5MB	31.2MB	615	128	656	26	2	4	SM	ST506/412	(2,7)RLL	588	85ms	15.0m	7.5Mb		20K	14.5W		
MS3438+	5.25	HALF	37.5MB	31.2MB	615	128	656	26	2	4	SM	ST506/412	(2,7)RLL	588	53ms	15.0m	7.5Mb		20K	18.6W		
MS3650	5.25	HALF	49.4MB	40.3MB	809	128	852	17	3	6	SM	ST506/412	(1,3)RLL	763	61ms	15.0m	5.0Mb		25K	18.1W		
MS3650F	5.25	HALF	49.4MB	40.3MB	809	128	852	17	3	6	SM	ST506/412	(1,3)RLL	763	46ms	15.0m	5.0Mb					
MS3650R	5.25	HALF	74.0MB	61.6MB	809	128	852	26	3	6	SM	ST506/412	(2,7)RLL	763	61ms	15.0m	7.5Mb		25K	18.1W		
MS3675	5.25	HALF	74.0MB	61.6MB	809	128	852	26	3	6	SM	ST506/412	(2,7)RLL	763	61ms	15.0m	7.5Mb		25K	18.1W		
MS4010	5.25	FULL	9.8MB	8.0MB	480	128	522	17	1	2	SM	ST506/412	(1,3)RLL	408	*ms	18.0m	5.0Mb		10K	23.0W	*133ms AVE ACCESS	
MS4020	5.25	FULL	19.5MB	15.9MB	480	128	522	17	2	4	SM	ST506/412	(1,3)RLL	402	*ms	18.0m	5.0Mb		10K	23.0W	*133ms AVE ACCESS	
MS5330	5.25		30.0MB	25.1MB	480	128		17	3	6		ST506/412	(1,3)RLL				5.0Mb					
MS5338	5.25		38.0MB	32.0MB	612	128		17	3	6		ST506/412	(1,3)RLL				5.0Mb					
MS5440	5.25		40.0MB	33.4MB	480	128		17	4	8		ST506/412	(1,3)RLL				5.0Mb					
MS5451	5.25		51.0MB	43.0MB	612	128		17	4	8		ST506/412	(1,3)RLL				5.0Mb					
MS6032	5.25	FULL	32.0MB	26.7MB	1024	512	AUTO	17	2	3	SM	ST506/412	(1,3)RLL	1000	28ms	6.0ms	5.0Mb		25K	18.0W		
MS6053	5.25	FULL	53.3MB	44.6MB	1024	512	AUTO	17	3	5	SM	ST506/412	(1,3)RLL	1000	28ms	6.0ms	5.0Mb		25K	18.0W		
MS6074	5.25	FULL	74.0MB	62.4MB	1024	512	AUTO	17	4	7	SM	ST506/412	(1,3)RLL	1000	28ms	6.0ms	5.0Mb		25K	18.0W		
MS6079	5.25	FULL	80.0MB	68.2MB	1024	512	AUTO	26	3	5	SM	ST506/412	(2,7)RLL	1000	28ms	6.0ms	7.5Mb		25K	18.0W		
MS6085	5.25	FULL	85.3MB	71.3MB	1024	512	AUTO	17	4	8	SM	ST506/412	(1,3)RLL	1000	28ms	6.0ms	5.0Mb		25K	18.0W		
MS6128	5.25	FULL	128.0MB	109.1MB	1024	512	AUTO	26	4	8	SM	ST506/412	(2,7)RLL	1000	28ms	66.0m	7.5Mb		25K	18.0W		
MS6170E	5.25	FULL	170.0MB	130.0MB	1024	512	AUTO	34	4	8		ESDI	(2,7)RLL		28ms		10.0Mb					
MS6212	5.25		12.0MB	10.0MB	612	128		17	1	2		ST506/412	(1,3)RLL				5.0Mb					
MS7426	5.25		26.0MB	21.0MB	612	128		17	2	4		ST506/412	(1,3)RLL				5.0Mb					
MS8412	5.25		12.0MB	10.0MB	306	128		17	2	4		ST506/412	(1,3)RLL				5.0Mb					
MS9380E	5.25	FULL	382.5MB	382.5MB	1224	NONE	AUTO	36	8	15	VC	ESDI	(2,7)RLL	1100	15ms	3.8ms	10.0Mb		50K	18.0W		

MODEL NUMBER	--SIZE--		-----CAPACITY-----		-----PHYSICAL-----					-LOGICAL-			RECORD METHOD	TKS /IN.	--ACCESS--		XFER RATE	CACHE	MTBF	POWER USED	COMMENTS
	WTH.	HGT.	UNFORMAT	FORMATED	PRE-COMP	LAND ZONE	S/TK	# PL	RW HD AC	INTER-FACE	S/TK	RW HD			AVE.	TK/TK					
MS9380S	5.25	FULL	382.0MB	347.0MB	1224	512	AUTO	8	15	VC	SCSI	(2,7)RLL	1100	15ms	10.0Mb		30K	17.4W			
MS9380SM	5.25	FULL	382.0MB	347.0MB	1224	512	AUTO	8	15	VC	SCSI(M)	(2,7)RLL	1100	15ms	10.0Mb		30K	17.4W	MACINTOSH		
MS9424E	5.25	FULL	424.0MB	360.0MB	1661	512		4	8	ESDI		(2,7)RLL	1498	17ms	15.0Mb			17.0W			
MS9424S	5.25	FULL	424.0MB	355.0MB	1661	512		4	8	SCSI		(2,7)RLL	1498	17ms	15.0Mb			17.0W			
MS9780E	5.25	FULL	794.9MB	676.1MB	1661	NONE	AUTO	53	8	15	VC	ESDI	(1,7)RLL	1495	17ms	4.5ms	15.0Mb	50K	18.0W		
MS9780S	5.25	FULL	781.0MB	668.0MB	1661	512	AUTO	8	15	VC	SCSI	(1,7)RLL	1495	17ms	15.0Mb			18.0W			
MINISTOR																					
MiniPORT 32 [P]	1.80	0.4"		32.0MB		NONE	AUTO	1	2	VC	IDE(AT)			18ms			256KB			[P]PCMCIA VER. AVAILABLE	
MiniPORT 42 [P]	1.80			42.0MB		NONE	AUTO			VC	IDE(AT)									[P]PCMCIA VER. AVAILABLE	
MiniPORT 64 [P]	1.80	0.5"		64.0MB		NONE	AUTO	MZ	2	4	VC	IDE(AT)		18ms			256KB			[P]PCMCIA VER. AVAILABLE, MZR	
MiniPORT 85 [P]	1.80			85.0MB		NONE	AUTO			VC	IDE(AT)									[P]PCMCIA VER. AVAILABLE	
MITSUBISHI																					
MR335	3.50	HALF	54.1MB		743		AUTO	4	7	VC	ST506/412	(1,3)RLL	1042	20ms	5.0ms	5.0Mb		30K	9.3W		
MR521	5.25	HALF		10.0MB	612	128		17	1	2	ST506/412	(1,3)RLL		85ms		5.0Mb					
MR522	5.25	HALF		20.0MB	612	300		17	2	4	ST506/412	(1,3)RLL		85ms		5.0Mb					
MR5310E	5.25	HALF	101.7MB				AUTO			VC	ESDI	(2,7)RLL		25ms							
MR535	5.25	HALF		42.0MB	977	300		17	3	5	ST506/412	(1,3)RLL		28ms		5.0Mb					
MR535R	5.25	HALF	76.3MB	65.0MB	977	300	AUTO	26	3	5	VC	ST506/412	(2,7)RLL	1028	28ms	5.0ms	7.5Mb	30K	18.4W		
MR535S	5.25	HALF	50.9MB	42.5MB	977	300	AUTO		3	5	VC	SCSI	(1,3)RLL	1028	28ms	5.0ms	5.0Mb	30K	18.4W		
MR537S	5.25	HALF	76.3MB	65.0MB	977	300	AUTO		3	5	VC	SCSI	(2,7)RLL	1028	28ms	5.0ms	7.5Mb	30K	18.4W		
MMI																					
M-106	3.50	HALF	6.0MB	5.0MB	306	128		17	1	2	ST506/412	(1,3)RLL		75ms		5.0Mb					
M-112	3.50	HALF	12.0MB	10.0MB	306	128		17	2	4	ST506/412	(1,3)RLL		75ms		5.0Mb					
M-125	3.50	HALF	25.0MB	20.0MB	306	128		17	4	8	ST506/412	(1,3)RLL		75ms		5.0Mb					
M-212	5.25	HALF	12.0MB	10.0MB	306	128		17	2	4	ST506/412	(1,3)RLL		75ms		5.0Mb					
M-225	5.25	HALF	25.0MB	20.0MB	306	128		17	4	8	ST506/412	(1,3)RLL		75ms		5.0Mb					
M-306	5.25	HALF	6.0MB	5.0MB	306	128		17	1	2	ST506/412	(1,3)RLL		75ms		5.0Mb					
M-312	5.25	HALF	12.0MB	10.0MB	306	128		17	2	4	ST506/412	(1,3)RLL		75ms		5.0Mb					
M-325	5.25	HALF	25.0MB	20.0MB	306	128		17	4	8	ST506/412	(1,3)RLL		75ms		5.0Mb					
NCL AMERICA																					
9220	3.50	HALF		200.0MB			AUTO	5		VC		(2,7)RLL	1378	17ms	3.8ms	10.0Mb	64KB	50K		3,565 RPM	

NCR

MODEL NUMBER	--SIZE--		-----CAPACITY-----		-----PHYSICAL-----							-----LOGICAL-----			RECORD METHOD	TKS /IN.	---ACCESS---		XFER RATE	CACHE	MTBF	POWER USED	COMMENTS		
	WTH.	HGT.	UNFORMAT	FORMATED	CYLS	PRE-COMP	LAND ZONE	S/TK	#PL	RW	HD	AC	INTER-FACE	CYLS			TK	HD						AVE.	TK/TK
6091-5101	5.25		323.0MB									AUTO	9		SCSI		(2,7)RLL	27ms	12.0Mb						
6091-5301	5.25		675.0MB									AUTO	15		SCSI		(2,7)RLL	25ms	15.0Mb						
NEC																									
D1711	1.80	12.7		42.6MB	1104	NONE	AUTO	1	2	VC		IDE(AT)				(1,7)RLL	2550	19ms	5.0ms	24.0Mb	32KB	100K	1.5W	5,400 RPM	
D1731	1.80	15.0		85.3MB	1104	NONE	AUTO	2	4	VC		IDE(AT)				(1,7)RLL	2550	19ms	5.0ms	24.0Mb	32KB	100K	1.2W	5,400 RPM	
D3126	3.50	HALF	26.0MB	20.0MB	615	300		17	2	4		ST506/412				(1,3)RLL		85ms		5.0Mb					
D3142	3.50	HALF	53.4MB	42.0MB	642	128	664	17	4	8		ST506/412				(1,3)RLL	850	28ms	8.0ms	5.0Mb	30K			32 S/T @ 256B/SECTOR	
D3146H	3.50	HALF	51.3MB	40.3MB	615			AUTO	17	4	8	VC	ST506/412			(1,3)RLL	850	35ms	8.0ms	5.0Mb	30K	9.2W		32 S/T @ 256B/SECTOR	
D3661	3.50	HALF	134.5MB	118.1MB	915			AUTO	36	4	7	VC	ESDI			(2,7)RLL	1311	20ms		10.0Mb	30K	7.5W			
D3735	3.50	25.4	56.0MB	45.5MB	1084			AUTO	41	1	2	VC	IDE(AT)			(1,7)RLL	1750	20ms		12.0Mb	30K	4.0W			
D3755	3.50	25.4	130.0MB	105.0MB	1250			AUTO	41	2	4	VC	IDE(AT)			(1,7)RLL	1750	20ms		12.0Mb	30K	4.8W			
D3756	3.50	25.4	131.0MB	105.0MB	1251	NONE	AUTO	41	2	4	VC	IDE(AT)				(1,7)RLL	1800	19ms		12.0Mb	32KB	50K	2.9W	3,456 RPM	
D3761	3.50	HALF	134.5MB	114.8MB	915			AUTO	35	4	7	VC	IDE(AT)			(2,7)RLL	1311	20ms		21.0Mb	30K	7.5W			
D3765	3.50	HALF		176.0MB				AUTO		4	VC	IDE(AT)						17ms		18.4Mb					
D3781	3.50	HALF	521.0MB	425.0MB	1464			AUTO	63	5	9	VC	IDE(AT)			(1,7)RLL	2000	15ms		20.0Mb	50K	8.5W			
D3835	3.50	25.4	56.0MB	45.5MB	1084			AUTO	41	1	2	VC	SCSI			(1,7)RLL	1750	20ms		12.0Mb	30K	4.0W			
D3855	3.50	25.4	130.0MB	105.0MB	1250			AUTO	41	2	4	VC	SCSI			(1,7)RLL	1750	20ms		12.0Mb	30K	4.8W			
D3856	3.50	25.4	131.0MB	105.0MB	1251	NONE	AUTO	41	2	4	VC	SCSI				(1,7)RLL	1800	19ms		12.0Mb	32KB	50K	3.7W	3,456 RPM	
D3861	3.50	HALF	134.5MB	114.8MB	915			AUTO	35	4	7	VC	SCSI			(2,7)RLL	1311	20ms		21.0Mb	30K	7.5W			
D3865	3.50	HALF		176.0MB				AUTO		4	VC	SCSI						17ms		18.4Mb					
D3881	3.50	HALF	521.0MB	425.0MB	1464	NONE	AUTO	63	5	9	VC	SCSI-2				(1,7)RLL	2000	15ms		20.0Mb	64KB	50K	8.5W		
D2384S	5.25	FULL		384.0MB		NONE	AUTO					SCSI-2				N/A		.35m		40.0Mb				SOLID STATE DISK, 64MB->384MB	
D5124	5.25	HALF		10.0MB	309				17	2	4		ST506/412			(1,3)RLL		85ms		5.0Mb					
D5126	5.25	HALF	26.0MB	20.0MB	612				17	2	4	SM	ST506/412			(1,3)RLL		85ms		5.0Mb					
D5126H	5.25	HALF	26.0MB	20.0MB	612				17	2	4		ST506/412			(1,3)RLL		40ms		5.0Mb					
D5146	5.25	HALF		40.0MB	615				17	4	8		ST506/412			(1,3)RLL		85ms		5.0Mb					
D5146H	5.25	HALF	46.0MB	40.0MB	615				17	4	8		ST506/412			(1,3)RLL		40ms		5.0Mb					
D5392	5.25	FULL	1322.0MB					AUTO		16	VC		IPI-2					14ms		24.0Mb	100K				
D5652	5.25	HALF		143.0MB	823				5	10			ESDI			(2,7)RLL		23ms		10.0Mb					
D5655	5.25	HALF	179.8MB	153.5MB	1224			AUTO	35	4	7	VC	ESDI			(2,7)RLL	1240	18ms		10.0Mb	30K	20.0W			
D5662	5.25	FULL	385.4MB						4	8			ESDI			(2,7)RLL	1240	18ms		10.0Mb					

MODEL NUMBER	--SIZE--		-----CAPACITY-----		-----PHYSICAL-----						--LOGICAL--			RECORD METHOD	TKS /IN.	--ACCESS--		XFER RATE	CACHE	MTBF	POWER USED	COMMENTS
	WTH.	HGT.	UNFORMAT	FORMATED	CYLS	PRE-COMP	LAND ZONE	S/TK	# PL	RW HD AC	INTER-FACE	CYLS	S/TK			RW HD	AVE.					
D5682	5.25	FULL	765.4MB	664.7MB	1633		AUTO	53	8	15	VC	ESDI		(1,7)RLL	1480	16ms	15.0Mb		50K	32.0W		
D5862	5.25	FULL	385.4MB						4	8		SCSI			1240	18ms	10.0Mb					
D5882	5.25	FULL	765.4MB	664.7MB	1633		AUTO	53	8	15	VC	SCSI		(1,7)RLL	1480	16ms	15.0Mb		50K	32.0W		
D5892	5.25	FULL	1607.0MB	1404.0MB	1678		AUTO	86	10	19	VC	SCSI(S)		(1,7)RLL	1603	14ms	24.0Mb		100K		TRANSFER(SYNC)=40Mb/S	
SD020S	5.25	HALF		20.0MB		NONE	AUTO					SCSI				.3ms	20.8Mb		250K	11.0W	SOLID STATE DISK, SYNC: 36Mb/S	
SD040S	5.25	HALF		40.0MB		NONE	AUTO					SCSI				.3ms	20.8Mb		200K	11.0W	SOLID STATE DISK, SYNC: 36Mb/S	
SD120S	5.25	FULL		120.0MB		NONE	AUTO					SCSI				.3ms	20.8Mb		120K	10.0W	SOLID STATE DISK, SYNC: 36Mb/S	
NEWBURY DATA																						
NDR-340	3.50	HALF		42.0MB	615			17	4	8		ST506/412		(1,3)RLL		40ms	5.0Mb					
NDR-1065	5.25	FULL	65.0MB	55.9MB	918			17	4	7		ST506/412		(1,3)RLL		25ms	5.0Mb					
NDR-1085	5.25	FULL	85.0MB	71.3MB	1025			17	4	8		ST506/412		(1,3)RLL		26ms	5.0Mb					
NDR-1105	5.25	FULL	105.0MB	87.9MB	918			17	6	11		ST506/412		(1,3)RLL		25ms	5.0Mb		20K			
NDR-1140	5.25	FULL	140.0MB	119.8MB	918			17	8	15		ST506/412		(1,3)RLL		25ms	5.0Mb					
NDR-2190	5.25	FULL	190.0MB	159.8MB	1224			17	8	15		ST506/412		(1,3)RLL		28ms	5.0Mb					
NDR-3170S	5.25	FULL	170.0MB	146.6MB	1224			26	5	9		SCSI		(2,7)RLL		28ms	7.5Mb					
NDR-3280S	5.25	FULL	280.0MB	244.0MB	1224			26	8	15		SCSI		(2,7)RLL		28ms	7.5Mb					
NDR-3380S	5.25	FULL	380.0MB	319.0MB	1224			34	8	15		SCSI		(2,7)RLL		28ms	10.0Mb					
NDR-4175	5.25	FULL		179.0MB	1224		AUTO	36	4	7		ESDI		(2,7)RLL		28ms	10.0Mb					
NDR-4380	5.25	FULL		384.0MB	1224		AUTO	36	8	15		ESDI		(2,7)RLL		28ms	10.0Mb					
NIPPON																						
NPO4-13T	5.25	FULL	13.0MB	10.0MB				17				ST506/412		(1,3)RLL		85ms	5.0Mb					
NPO4-14C	5.25	FULL		22.6MB	650			17	2	4		ST506/412										
OKIDATA																						
OD526				31.0MB	640			26	2	4		ST506/412		(2,7)RLL			7.5Mb					
OD540				47.0MB	640			26	3	6		ST506/412		(2,7)RLL			7.5Mb					
OLIVETTI																						
HD662/11				10.0MB	612			17	1	2		ST506/412		(1,3)RLL			5.0Mb					
HD662/12				20.0MB	612			17	2	4		ST506/412		(1,3)RLL			5.0Mb					
5210/2	5.25	HALF		10.0MB	612			17	1	2		ST506/412		(1,3)RLL		85ms	5.0Mb					
5220/2	5.25	FULL		20.0MB	612			17	2	4		ST506/412		(1,3)RLL		65ms	5.0Mb					
OPTIMA																						

MODEL NUMBER	--SIZE--		-----CAPACITY-----		-----PHYSICAL-----				INTER- FACE	-LOGICAL-			RECORD METHOD	TKS /IN.	--ACCESS--		XFER RATE	CACHE	MTBF	POWER USED	COMMENTS
	WTH.	HGT.	UNFORMAT	FORMATED	PRE- CYLS	LAND ZONE	S/ TK	# PL		RW HD	HD AC	S/ TK			RW HD	AVE. TK/TK					
DISCOVERY 130	3.50	HALF		136.6MB		AUTO							SCSI			25ms	12.0Mb	30K	10.4W	XFER(SYNC)=20.0Mb, EXTERNAL	
DISCOVERY 130IS	3.50	HALF		136.6MB		AUTO							SCSI(M)			25ms	12.0Mb	30K	10.4W	X(SYNC)=20.0Mb, MAC, INTERNAL	
DISCOVERY 200	3.50	HALF		200.0MB		AUTO							SCSI			17ms	12.0Mb	40K	13.0W	XFER(SYNC)=32.0Mb, EXTERNAL	
DISCOVERY 200IS	3.50	HALF		200.0MB		AUTO							SCSI(M)			17ms	12.0Mb	40K	13.0W	X(SYNC)=32.0Mb, MAC, INTERNAL	
DISCOVERY 260IM	3.50	HALF		2x130MB		AUTO							SCSI(M)			25ms	9.7Mb			DUAL DRIVES, MAC, INTERNAL	
DISCOVERY 310IS	3.50	HALF		310.0MB		AUTO							SCSI(M)			13ms	16.0Mb			MAC, INTERNAL	
DISCOVERY 325	3.50	HALF		321.0MB		AUTO							SCSI			14ms	16.0Mb	100K	20.0W	XFER(SYNC)=38.4Mb, EXTERNAL	
DISCOVERY 325I	3.50	HALF		321.0MB		AUTO							SCSI(M)			14ms	16.0Mb	100K	20.0W	X(SYNC)=38.4Mb, MAC, INTERNAL	
DISCOVERY 40	3.50	HALF		45.0MB		AUTO							SCSI			25ms	12.0Mb	30K	9.2W	XFER(SYNC)=20.0Mb, EXTERNAL	
DISCOVERY 400IM	3.50	HALF		2x200MB		AUTO							SCSI(M)			17ms	14.0Mb			DUAL DRIVES, MAC, INTERNAL	
DISCOVERY 40IS	3.50	HALF		45.0MB		AUTO							SCSI(M)			25ms	12.0Mb	30K	9.2W	X(SYNC)=20.0Mb, MAC, INTERNAL	
DISCOVERY 420	3.50	HALF		416.0MB		AUTO			8				SCSI	(2,7)RLL		16ms	13.3Mb	100K	20.0W	XFER(SYNC)=38.4Mb, EXTERNAL	
DISCOVERY 420I	3.50	HALF		416.0MB		AUTO			8				SCSI(M)	(2,7)RLL		16ms	13.3Mb	100K	20.0W	X(SYNC)=38.4Mb, MAC, INTERNAL	
DISCOVERY 45R	3.50	HALF		45.0MB		AUTO							SCSI			25ms	7.6Mb			REMOVABLE CARTRIDGE, EXTERNAL	
DISCOVERY 620IM	3.50	HALF		2x310MB		AUTO							SCSI(M)			13ms	16.0Mb			DUAL DRIVES, MAC, INTERNAL	
DISCOVERY 80IM	3.50	HALF		2x40MB		AUTO							SCSI(M)			25ms	9.7Mb			DUAL DRIVES, MAC, INTERNAL	
MINIPAK 130	3.50	HALF		136.6MB		AUTO			4				SCSI	(2,7)RLL		25ms	9.7Mb	30K	10.4W	EXTERNAL	
MINIPAK 130I( )	3.50	HALF		136.6MB		AUTO							SCSI(M)			25ms	9.7Mb	30K	10.4W	MAC/CL,/SE,/si, INTERNAL	
MINIPAK 200	3.50	HALF		209.0MB		AUTO			8				SCSI	(2,7)RLL		17ms	14.0Mb	40K	13.0W	EXTERNAL	
MINIPAK 200I( )	3.50	HALF		209.0MB		AUTO							SCSI(M)			17ms	14.0Mb	40K	13.0W	MAC/CL,/SE,/si, INTERNAL	
MINIPAK 310	3.50	HALF		306.0MB		AUTO							SCSI	(2,7)RLL		13ms	16.0Mb	150K	15.5W	EXTERNAL	
MINIPAK 310I( )	3.50	HALF		306.0MB		AUTO							SCSI(M)			13ms	16.0Mb	150K	15.5W	MAC/CL,/SE,/si, INTERNAL	
MINIPAK 40	3.50	HALF		45.0MB		AUTO							SCSI			25ms	9.7Mb	30K	9.2W	EXTERNAL	
MINIPAK 40I( )	3.50	HALF		45.0MB		AUTO							SCSI(M)			25ms	9.7Mb	30K	9.2W	MAC/CL,/SE,/si, INTERNAL	
CONCORDE 1050	5.25	FULL		1050.0MB		AUTO			15				SCSI	(2,7)RLL		15ms	23.0Mb	50K	29.0W	XFER(SYNC)=38.4Mb, EXTERNAL	
CONCORDE 1350	5.25	FULL		1352.0MB		AUTO							SCSI	(2,7)RLL		14ms	16.0Mb	150K	36.0W	XFER(SYNC)=40.0Mb, EXTERNAL	
CONCORDE 635	5.25	FULL		640.0MB		AUTO			14				SCSI	(2,7)RLL		16ms	12.0Mb	150K	36.0W	XFER(SYNC)=32.0Mb, EXTERNAL	
ORCA TECH.																					
320A	3.50	HALF	370.0MB						9				IDE(AT)	(2,7)RLL		12ms		100K			
320S	3.50	HALF	370.0MB						9				SCSI	(2,7)RLL		12ms		100K			
400A	3.50	HALF	470.0MB						9				IDE(AT)	(2,7)RLL		12ms		100K			

MODEL NUMBER	--SIZE--		-----CAPACITY-----		-----PHYSICAL-----						-LOGICAL-			TKS /IN.	--ACCESS--		XFER RATE	CACHE	MTBF	POWER USED	COMMENTS			
	WTH.	HGT.	UNFORMAT	FORMATED	PRE- CYLS	LAND COMP	S/ ZONE	# PL	RW HD	HD AC	INTER- FACE	S/ CYLS	RW TK		HD	RECORD METHOD						AVE. TK/TK	TK/TK	
400S	3.50	HALF	470.0MB						9	SCSI				(2,7)RLL	12ms			100K						
760E	5.25		760.0MB				AUTO		15	ESDI				(2,7)RLL	14ms	15.0Mb		50K						
760S	5.25		760.0MB				AUTO		15	SCSI				(2,7)RLL	14ms	15.0Mb		50K						
OTARI																								
C-214			14.0MB	10.0MB	306	128		17	2	4			ST506/412	(1,3)RLL		5.0Mb								
C-519			19.0MB	15.0MB	306	128		17	3	6			ST506/412	(1,3)RLL		5.0Mb								
C-526			26.0MB	21.0MB	306	128		17	4	8			ST506/412	(1,3)RLL		5.0Mb								
PANASONIC																								
JU-116	3.50	HALF		20.0MB	615			17	2	4			ST506/412	(1,3)RLL	85ms	5.0Mb								
JU-128	3.50	HALF		42.0MB	734			17	4	7			ST506/412	(1,3)RLL	35ms	5.0Mb								
RD-210AA	3.50	1.0"		210.0MB											16ms			6.4W						
PERIPHERAL LAND																								
PL-100 TURBO	3.50	HALF		105.0MB					4	SCSI				(2,7)RLL	19ms			60K						
PL-200 TURBO	3.50	HALF		210.0MB					7	SCSI				(2,7)RLL	19ms			50K						
PL-320 TURBO	3.50	HALF		320.0MB					14	SCSI				(2,7)RLL	12ms			100K						
PLUS DEVELOPMENT																								
HARDCARD 20	3.50	1.0"		21.2MB		AUTO				VC	IBM/XT				40ms			60K		DRIVE CARD, 3:1, 8 BIT				
HARDCARD 40	3.50	1.0"		42.2MB		AUTO				VC	IBM/XT				40ms			60K		DRIVE CARD, 3:1, 8 BIT				
HARDCARD2 80	3.50	1.0"		80.5MB		AUTO				VC	IBM/AT			(2,7)RLL	25ms	64KB	60K			DRIVE CARD, 1:1, 16 BIT				
HARDCARD2 XL105	3.50	1.0"		105.2MB		AUTO				VC	IBM/AT			(2,7)RLL	17ms	64KB	60K			DRIVE CARD, 1:1, 16 BIT				
HARDCARD2 XL50	3.50	1.0"		52.3MB		AUTO				VC	IBM/AT			(2,7)RLL	17ms	64KB	60K			DRIVE CARD, 1:1, 16 BIT				
IMPULSE 105AT/L	3.50	1.0"		105.1MB	1219	NONE	AUTO	MZ	2	4	VC	IDE(AT)	755	17	16	(2,7)RLL	1330	17ms	6.0ms	11.2Mb	64KB	60K	5.5W	MZR:3-ZONE, 3,660 RPM
IMPULSE 105S	3.50	HALF		105.1MB	1019	NONE	AUTO	MZ	3	6	VC	SCSI				(2,7)RLL	1225	19ms	6.0ms	16.0Mb	64KB	50K	9.0W	MZR:2-ZONE, 3,660 RPM
IMPULSE 105S/LP	3.50	1.0"		105.1MB	1219	NONE	AUTO	MZ	2	4	VC	SCSI				(2,7)RLL	1330	17ms	6.0ms	16.0Mb	64KB	60K	6.5W	MZR:3-ZONE, 3,660 RPM
IMPULSE 120AT	3.50	HALF		120.0MB	1123	NONE	AUTO	MZ	3	5	VC	IDE(AT)	814	17	9	(1,7)RLL	1414	15ms	4.0ms	8.0Mb	64KB	50K	12.0W	MZR:2-ZONE, 3,605 RPM
IMPULSE 120S	3.50	HALF		120.0MB	1123	NONE	AUTO	MZ	3	5	VC	SCSI				(1,7)RLL	1414	15ms	4.0ms	18.4Mb	64KB	50K	12.0W	MZR:2-ZONE, 3,605 RPM
IMPULSE 170AT	3.50	HALF		168.5MB	1123	NONE	AUTO	MZ	4	7	VC	IDE(AT)	968	17	10	(1,7)RLL	1414	15ms	4.0ms	8.0Mb	64KB	50K	12.0W	MZR:2-ZONE, 3,605 RPM
IMPULSE 170S	3.50	HALF		168.5MB	1123	NONE	AUTO	MZ	4	7	VC	SCSI				(1,7)RLL	1414	15ms	4.0ms	18.4Mb	64KB	50K	12.0W	MZR:2-ZONE, 3,605 RPM
IMPULSE 210AT	3.50	HALF		209.3MB	1156	NONE	AUTO	MZ	4	7	VC	IDE(AT)	873	17	13	(1,7)RLL	1454	15ms	4.0ms	8.0Mb	64KB	50K	12.6W	MZR:8-ZONE, 3,605 RPM
IMPULSE 210S	3.50	HALF		209.3MB	1156	NONE	AUTO	MZ	4	7	VC	SCSI				(1,7)RLL	1454	15ms	4.0ms	18.4Mb	64KB	50K	12.6W	MZR:2-ZONE, 3,605 RPM
IMPULSE 330AT	3.50	HALF		331.2MB		AUTO	MZ				VC	IDE(AT)				(1,7)RLL		14ms		64KB	75K			MZR:8-ZONE



MODEL NUMBER	--SIZE--		-----CAPACITY-----		-----PHYSICAL-----						-LOGICAL-			--ACCESS--		XFER RATE	CACHE	MTBF	POWER USED	COMMENTS			
	WTH.	HGT.	UNFORMAT	FORMATED	CYLS	PRE-COMP	LAND ZONE	S/TK	#PL	RW HD AC	INTER-FACE	CYLS	S/TK	RW HD	RECORD METHOD						TKS /IN.	AVE. TK/TK	
IMPULSE 330S	3.50	HALF		331.2MB			AUTO	MZ		VC	SCSI				(1,7)RLL		14ms		64KB	75K		MZR:8-ZONE	
IMPULSE 40AT	3.50	HALF		41.9MB	834	NONE	AUTO	MZ	2	3	VC	IDE(AT)			(2,7)RLL	1000	19ms 6.0ms	8.0Mb	64KB	50K	9.0W	MZR:2-ZONE, 3,660 RPM	
IMPULSE 40S	3.50	HALF		41.9MB	834	NONE	AUTO		2	3	VC	SCSI			(2,7)RLL	1000	19ms 6.0ms	16.0Mb	64KB	50K	9.0W	MZR:2-ZONE, 3,660 RPM	
IMPULSE 425AT	3.50	HALF		425.8MB			AUTO				VC	IDE(AT)			(1,7)RLL		14ms		64KB	75K		MZR:8-ZONE	
IMPULSE 425S	3.50	HALF		425.8MB			AUTO				VC	SCSI			(1,7)RLL		14ms		64KB	75K		MZR:8-ZONE	
IMPULSE 52AT/LP	3.50	1.0"		52.2MB	1219	NONE	AUTO		1	2	VC	IDE(AT)	751	17	8	(2,7)RLL	1330	17ms 6.0ms	11.2Mb	64KB	60K	5.5W	MZR:3-ZONE, 3,660 RPM
IMPULSE 52S/LP	3.50	1.0"		52.2MB	1219	NONE	AUTO		1	2	VC	SCSI			(2,7)RLL	1330	17ms 6.0ms	16.0Mb	64KB	60K	6.5W	MZR:3-ZONE, 3,660 RPM	
IMPULSE 80AT	3.50	HALF		83.9MB	834	NONE	AUTO		3	6	VC	IDE(AT)			(2,7)RLL	1000	19ms 6.0ms	8.0Mb	64KB	50K	9.0W	MZR:2-ZONE, 3,660 RPM	
IMPULSE 80AT/LP	3.50	1.0"		85.7MB		NONE	AUTO		2	4	VC	IDE(AT)	616	17	16	(2,7)RLL	1330	17ms 6.0ms	11.2Mb	64KB	60K	5.5W	MZR:3-ZONE, 3,660 RPM
IMPULSE 80S	3.50	HALF		83.9MB	918	NONE	AUTO		3	6	VC	SCSI			(2,7)RLL	1000	19ms 6.0ms	16.0Mb	64KB	50K	9.0W	MZR:2-ZONE, 3,660 RPM	
IMPULSE 80S/LP	3.50	1.0"		85.7MB		NONE	AUTO		2	4	VC	SCSI			(2,7)RLL	1330	17ms 6.0ms	16.0Mb	64KB	60K	6.5W	MZR:3-ZONE, 3,660 RPM	
PASSPORT 20	5.25	HALF		21.4MB							VC				(2,7)RLL				8KB	60K		1:1	
PASSPORT 40	5.25	HALF		42.6MB							VC				(2,7)RLL				8KB	60K		1:1	
PRAIRIETEK																							
PRAIRIE 120	2.50	0.6"		21.4MB	615	NONE	AUTO	34	1	2	VC	IDE(*)			(2,7)RLL	1350	23ms 8.0ms	10.0Mb		20K	2.5W	(*)XT/AT SWITCHABLE, 3,307 RPM	
PRAIRIE 140	2.50	0.6"		40.0MB			AUTO		1	2	VC	IDE			(2,7)RLL								
PRAIRIE 220A	2.50	1.0"		20.0MB	612		AUTO		2	4	VC	IDE(*)			(2,7)RLL	1150	28ms 10.0m	5.0Mb		20K	3.5W		
PRAIRIE 220S	2.50	1.0"		20.0MB	612		AUTO		2	4	VC	SCSI			(2,7)RLL	1150	28ms 10.0m	5.0Mb		20K	3.5W		
PRAIRIE 240	2.50	1.0"		42.8MB	615	NONE	AUTO	34	2	4	VC	IDE(*)			(2,7)RLL	1350	28ms 8.0ms	10.0Mb		20K	2.5W	(*)XT/AT SWITCHABLE, 3,307 RPM	
PRAIRIE 242A	2.50	1.0"		42.8MB	615	NONE	AUTO	34	2	4	VC	IDE(*)			(2,7)RLL	1350	23ms 8.0ms	10.0Mb		100K	2.5W	(*)XT/AT SWITCHABLE, 3,307 RPM	
PRAIRIE 242S	2.50	1.0"		42.8MB	615	NONE	AUTO	34	2	4	VC	SCSI			(2,7)RLL	1350	23ms 8.0ms	10.0Mb		100K	2.5W	3,307 RPM	
PRAIRIE 282S	2.50	1.0"		81.6MB			AUTO		2	4	VC	SCSI			(2,7)RLL								
PRAIRIE 282A	2.50	1.0"		81.6MB			AUTO		2	4	VC	IDE			(2,7)RLL								
PRIAM																							
3504	3.50	HALF		44.0MB							SM	ST506/412			(2,7)RLL		39ms						
ID100AT	5.25	FULL		103.0MB								ST506/412			(1,3)RLL		16ms						
ID120	5.25	HALF		121.1MB	1017		AUTO	34	4	7	VC	ESDI			(2,7)RLL		28ms		10.0Mb				
ID130AT/D2	5.25	FULL		132.9MB	1224		AUTO	17	8	15	VC	ST506/412			(1,3)RLL		20ms		5.0Mb			250MB AS RLL	
ID150E	5.25	HALF		159.0MB	1268			34	4	7		ESDI			(2,7)RLL		28ms		10.0Mb				
ID160E	5.25	FULL		156.0MB	1218			36	4	7		ESDI			(2,7)RLL		18ms		10.0Mb				
ID160E-PS/2	5.25	FULL		152.0MB	1195			36	4	7		PS/2			(2,7)RLL		18ms		10.0Mb				



MODEL NUMBER	--SIZE--		-----CAPACITY-----		-----PHYSICAL-----						-LOGICAL-				TKS /IN.	--ACCESS--		XFER RATE	CACHE	MTBF	POWER USED	COMMENTS
	WTH.	HGT.	UNFORMAT	FORMATED	CYLS	PRE-COMP	LAND ZONE	S/TK	# PL	RW HD AC	INTER-FACE	CYLS	S/TK	RW HD		RECORD METHOD	AVE. TK/TK					
P738	5.25	FULL	382.0MB	329.0MB	1225						SCSI				(2,7)RLL	20ms		10.0Mb				
V130R	5.25	FULL		39.0MB	987						ST506/412				(2,7)RLL			7.5Mb				see also VERTEX V130
V150	5.25	FULL		42.0MB	987						ST506/412				(1,3)RLL			5.0Mb				see also VERTEX V150
V160	5.25	FULL		50.0MB	1166						ST506/412				(1,3)RLL			5.0Mb				see also VERTEX V170
V170	5.25	FULL		60.0MB	987						ST506/412				(1,3)RLL	28ms		5.0Mb				
V170R	5.25	FULL		91.0MB	987						ST506/412				(2,7)RLL			7.5Mb				
V185	5.25	FULL		72.0MB	1166						ST506/412				(1,3)RLL	28ms		5.0Mb				
PROCOM TECHNOLOGY																						
MTD1900			1900.0MB			NONE					AUTO				SCSI-2F			13ms				EXTERNAL MAC
MTD2000			2000.0MB			NONE					AUTO				SCSI-2F			11ms				EXTERNAL MAC, 5,400 RPM
QD1900			1900.0MB			NONE					AUTO				SCSI-2F			13ms				INTERNAL MAC
QD2000			2000.0MB			NONE					AUTO				SCSI-2F			11ms				INTERNAL MAC, 5,400 RPM
PROPAQ 100	3.50	HALF		105.0MB											IDE(AT)			25ms		10.0Mb		20K
PROPAQ 185-15	3.50	HALF		189.0MB											IDE(AT)					5.9Mb		70K
PROPAD 80i	3.50	1.0"		80.0MB											IDE(AT)			19ms		12.0Mb		150K
Si 200/PS3	3.50	HALF		209.0MB											SCSI			(2,7)RLL	18ms		12.0Mb	70K
HiPer 380	5.25			388.0MB											ESDI			17ms				100K
Si 1000/S5	5.25			1037.0MB											SCSI			15ms		19.2Mb		40K
Si 585/S5	5.25			601.0MB											SCSI			17ms		22.4Mb		100K
PTI																						
PT-225	3.50	HALF		21.0MB	615										ST506/412			(1,3)RLL	35ms		5.0Mb	
PT-234	3.50	HALF		28.0MB	820										ST506/412			(1,3)RLL	35ms		5.0Mb	
PT-238A	3.50	HALF		32.0MB	615										IDE(AT)			(2,7)RLL	35ms		7.5Mb	
PT-238R	3.50	HALF		32.0MB	615										ST506/412			(2,7)RLL	35ms		7.5Mb	
PT-238S	3.50	HALF		32.0MB	615										SCSI			(2,7)RLL	35ms		7.5Mb	
PT-251A	3.50	HALF		43.0MB	820										IDE(AT)			(2,7)RLL	35ms		7.5Mb	
PT-251R	3.50	HALF		43.0MB	820										ST506/412			(2,7)RLL	35ms		7.5Mb	
PT-251S	3.50	HALF		43.0MB	820										SCSI			(2,7)RLL	35ms		7.5Mb	
PT-338	3.50	HALF		32.0MB	615										ST506/412			(1,3)RLL	35ms		5.0Mb	
PT-351	3.50	HALF		42.0MB	820										ST506/412			(1,3)RLL	35ms		5.0Mb	
PT-351R	3.50	HSLF		60.0MB											ST506/412			(2,7)RLL	30ms			

MODEL NUMBER	--SIZE--		-----CAPACITY-----		-----PHYSICAL-----						-LOGICAL-			--ACCESS--		XFER RATE	CACHE	MTBF	POWER USED	COMMENTS			
	WTH.	HGT.	UNFORMAT	FORMATED	CYLS	PRE-COMP	LAND ZONE	S/TK	# PL	RW HD AC	INTER-FACE	CYLS	S/TK	RW HD	RECORD METHOD						TKS /IN.	AVE. TK/TK	
PT-357A	3.50	HALF	49.0MB	615			26	3	6	IDE(AT)				(2,7)RLL		35ms	7.5mb						
PT-357R	3.50	HALF	49.0MB	615			26	3	6	ST506/412				(2,7)RLL		35ms	7.5mb						
PT-357S	3.50	HALF	49.0MB	615			26	3	6	SCSI				(2,7)RLL		35ms	7.5mb						
PT-376A	3.50	HALF	65.0MB	820			26	3	6	IDE(AT)				(2,7)RLL		35ms	7.5mb						
PT-376R	3.50	HALF	65.0MB	820			26	3	6	ST506/412				(2,7)RLL		35ms	7.5mb						
PT-376S	3.50	HALF	65.0MB	820			26	3	6	SCSI				(2,7)RLL		35ms	7.5mb						
PT-4102A	3.50	HALF	87.0MB	820		AUTO	26	4	8	IDE(AT)				(2,7)RLL		35ms							
PT-4102R	3.50	HALF	87.0MB	820			26	4	8	ST506/412				(2,7)RLL		35ms	7.5mb						
QUANTUM																							
Go*Drv-120A	2.50		130.0MB		NONE	AUTO	2	4	VC	IDE(AT)	731	26	13		2000	17ms	16.8mb	32KB	150K				
Go*Drv-120S	2.50		130.0MB		NONE	AUTO	2	4	VC	SCSI					2000	17ms	16.8mb	32KB	150K				
Go*Drv-40A	2.50	0.6"	42.9MB	870	NONE	AUTO	MZ	1	2	VC	IDE(AT)	820	17	6	(1,7)RLL	1700	16ms	5.0ms	12.0mb	8KB	150K	2.0W	112 BIT REED/SOLOMON ECC
Go*Drv-40S	2.50	0.6"	42.9MB	870	NONE	AUTO	MZ	1	2	VC	SCSI-2			(1,7)RLL	1700	16ms	5.0ms	12.0mb	8KB	150K	2.0W	112 BIT REED/SOLOMON ECC	
Go*Drv-60A	2.50		65.0MB		NONE	AUTO		1	2	VC	IDE(AT)	1024	17	7		2000	17ms	16.8mb	32KB	150K			
Go*Drv-60S	2.50		65.0MB		NONE	AUTO		1	2	VC	SCSI				2000	17ms	16.8mb	32KB	150K				
Go*Drv-80A	2.50	0.6"	83.6MB	870	NONE	AUTO	MZ	2	4	VC	IDE(AT)	1024	17	9	(1,7)RLL	1700	16ms	5.0ms	12.0mb	32KB	150K	2.0W	112 BIT REED/SOLOMON ECC
Go*Drv-80S	2.50	0.6"	83.6MB	870	NONE	AUTO	MZ	2	4	VC	SCSI-2			(1,7)RLL	1700	16ms	5.0ms	12.0mb	32KB	150K	2.0W	112 BIT REED/SOLOMON ECC	
ProDrv-100E	3.50	HALF	103.0MB							ESDI				(2,7)RLL		19ms	10.0mb						
ProDrv-1050S	3.50	HALF	1050.0MB		NONE	AUTO		7	14	VC	SCSI-2			(1,7)RLL	2127	10ms	80.0mb	512KB	250K		FAST SCSI, OPTIONAL DIFF. SCSI		
ProDrv-105S	3.50	HALF	105.0MB	1019		AUTO		3	6	VC	SCSI			(2,7)RLL	1225	19ms	16.0mb	64KB	50K	9.0W			
ProDrv-120AT	3.50	HALF	120.0MB	1123	NONE	AUTO	MZ	3	5	VC	IDE(AT)	814	32	9	(1,7)RLL	1414	15ms	4.0ms	18.4mb	64KB	50K	12.0W	48 BIT ECC, MZR:2-ZONE
ProDrv-120S	3.50	HALF	120.0MB	1123	NONE	AUTO	MZ	3	5	VC	SCSI			(1,7)RLL	1414	15ms	4.0ms	16.0mb	64KB	50K	12.0W	48 BIT ECC, MZR:2-ZONE	
ProDrv-1225S	3.50	HALF	1225.0MB		NONE	AUTO		7		VC	SCSI-2					10ms	80.0mb	512KB					
ProDrv-145E	3.50	HALF	145.0MB							ESDI				(2,7)RLL		19ms	10.0mb						
ProDrv-170AT	3.50	HALF	168.0MB	1123	NONE	AUTO	MZ	4	7	VC	IDE(AT)	968	34	10	(1,7)RLL	1414	15ms	4.0ms	18.4mb	64KB	50K	12.0W	48 BIT ECC, MZR:2-ZONE
ProDrv-170S	3.50	HALF	168.0MB	1123	NONE	AUTO	MZ	4	7	VC	SCSI			(1,7)RLL	1414	15ms	4.0ms	16.0mb	64KB	50K	12.0W	48 BIT ECC, MZR:2-ZONE	
ProDrv-210AT	3.50	HALF	210.0MB	1156	NONE	AUTO	MZ	4	7	VC	IDE(AT)	873	36	13	(1,7)RLL	1454	15ms	4.0ms	14.0ms	64KB	50K	12.6W	48BIT ECC,MZR:8-ZONE,3,606 RPM
ProDrv-210S	3.50	HALF	210.0MB	1156	NONE	AUTO	MZ	4	7	VC	SCSI			(1,7)RLL	1454	15ms	4.0ms	14.0mb	64KB	50K	12.6W	48BIT ECC,MZR:8-ZONE,3,606 RPM	
ProDrv-330AT	3.50	HALF	336.0MB			AUTO		4		VC	IDE(AT)			(1,7)RLL	1695	14ms	4.0ms	14.0mb	256KB	150K		MZR:8-ZONE, 3,606 RPM	
ProDrv-330S	3.50	HALF	336.0MB			AUTO		4		VC	SCSI			(1,7)RLL	1695	14ms	4.0ms	14.0ms	256KB	150K		MZR:8-ZONE, 3,606 RPM	
ProDrv-40AT	3.50	HALF	42.0MB	834		AUTO	28	2	3	VC	IDE(AT)	965	17	5	(2,7)RLL	1000	19ms	6.0ms		64KB	50K	9.0W	MZR:8-ZONE

MODEL NUMBER	--SIZE--		-----CAPACITY-----		-----PHYSICAL-----							-LOGICAL-			RECORD METHOD	TKS /IN.	--ACCESS--		XFER RATE	CACHE	MTBF	POWER USED	COMMENTS
	WTH.	HGT.	UNFORMAT	FORMATED	CYLS	PRE-COMP	LAND ZONE	S/TK	# PL	RW HD	HD AC	INTER-FACE	CYLS	TK			HD	AVE.					
ProDrv-40S	3.50	HALF		42.0MB	834		AUTO 28	2	3	VC	SCSI				(2,7)RLL	1000	19ms	6.0ms	16.0Mb	64KB	50K	9.0W	MZR:8-ZONE
ProDrv-425AT	3.50	HALF		426.5MB		NONE	AUTO MZ	5	9	VC	IDE(AT)	1021	51	16	(1,7)RLL	1695	14ms	4.0ms	32.0Mb	256KB	150K	12.8W	MZR:8-ZONE, 3,606 RPM
ProDrv-425i	3.50	HALF		426.5MB		NONE	AUTO MZ	5	9	VC	SCSI-2F				(1,7)RLL	1695	14ms	4.0ms	80.0Mb	256KB	150K		MZR:8-ZONE, 3,606 RPM
ProDrv-425iAT	3.50	HALF		426.5MB		NONE	AUTO MZ	5	9	VC	IDE(AT)	1021	51	16	(1,7)RLL	1695	14ms	4.0ms	80.0Mb	256KB	150K		MZR:8-ZONE, 3,606 RPM
ProDrv-425S	3.50	HALF		426.5MB		NONE	AUTO MZ	5	9	VC	SCSI-2				(1,7)RLL	1695	14ms	4.0ms	32.0Mb	256KB	150K	12.8W	MZR:8-ZONE, 3,606 RPM
ProDrv-80AT	3.50	HALF		84.0MB	834		AUTO 35	3	6	VC	IDE(AT)	965	17	10	(2,7)RLL	1000	19ms	6.0ms		64KB	50K	9.0W	
ProDrv-80S	3.50	HALF		84.0MB	834		AUTO 35	3	6	VC	SCSI				(2,7)RLL	1000	19ms	6.0ms	16.0Mb	64KB	50K	9.0W	
ProDrv-ELS-127A	3.50	1.0"		127.0MB		NONE	AUTO MZ			VC	IDE(AT)	919	17	16						32KB			MZR
ProDrv-ELS-127S	3.50	1.0"		127.0MB		NONE	AUTO MZ			VC	SCSI									32KB			MZR
ProDrv-ELS-170A	3.50	1.0"		170.0mb		NONE	AUTO MZ			VC	IDE(AT)	1011	22	15						32KB			MZR
ProDrv-ELS-170S	3.50	1.0"		170.0MB		NONE	AUTO MZ			VC	SCSI									32KB			MZR
ProDrv-ELS-42AT	3.50	1.0"		42.0MB		NONE	AUTO MZ			VC	IDE(AT)	968	17	5						32KB			MZR
ProDrv-ELS-42S	3.50	1.0"		42.0MB		NONE	AUTO MZ			VC	SCSI									32KB			MZR
ProDrv-ELS-85AT	3.50	1.0"		85.0MB		NOON	AUTO MZ			VC	IDE(AT)	977	17	10						32KB			MZR
ProDrv-ELS-85S	3.50	1.0"		85.0MB		NONE	AUTO MZ			VC	SCSI									32KB			MZR
ProDrv-GEM-160A	3.50			168.0MB			AUTO			VC	IDE(AT)				(2,7)RLL		19ms				80K		
ProDrv-GEM-160S	3.50			168.0MB			AUTO			VC	SCSI				(2,7)RLL		19ms				80K		
ProDrv-GEM-80A	3.50			84.0MB			AUTO			VC	IDE(AT)				(2,7)RLL		19ms				80K		
ProDrv-GEM-80S	3.50			84.0MB			AUTO			VC	SCSI				(2,7)RLL		19ms				80K		
ProDrv-LPS-105A	3.50	1.0"		105.0MB	1219	NONE	AUTO MZ	2	4	VC	IDE(AT)	755	17	16	(2,7)RLL	1330	17ms	5.0ms	18.4Mb	64KB	60K	6.5W	48-BIT ECC, MZR:3-ZONE
ProDrv-LPS-105S	3.50	1.0"		105.0MB	1219	NONE	AUTO MZ	2	4	VC	SCSI				(2,7)RLL	1330	17ms	5.0ms	16.0Mb	64KB	60K	6.5W	48-BIT ECC, MZR:3-ZONE
ProDrv-LPS-120A	3.50	1.0"		122.0MB	1800	NONE	AUTO MZ	1	2	VC	IDE(AT)	901	53	5	(1,7)RLL	1900	16ms	4.0ms	30.4Mb	256KB	250K	3.9W	96-BIT R/S ECC, 4,306 RPM
ProDrv-LPS-120S	3.50	1.0"		122.0MB	1800	NONE	AUTO MZ	1	2	VC	SCSI-2F				(1,7)RLL	1900	16ms	4.0ms	30.4Mb	256KB	250K	3.9W	96-BIT R/S ECC, 4,306 RPM
ProDrv-LPS-240A	3.50	1.0"		245.0MB	1800	NONE	AUTO MZ	2	4	VC	IDE(AT)	723	51	13	(1,7)RLL	1900	16ms	4.0ms	30.4Mb	256KB	250K	3.9W	96-BIT R/S ECC, 4,306 RPM
ProDrv-LPS-240S	3.50	1.0"		245.0MB	1800	NONE	AUTO MZ	2	4	VC	SCSI-2F				(1,7)RLL	1900	16ms	4.0ms	30.4Mb	256KB	250K	3.9W	96-BIT R/S ECC, 4,306 RPM
ProDrv-LPS-450	3.50	1.0"		450.0MB																			
ProDrv-LPS-52AT	3.50	1.0"		52.0MB	1219	NONE	AUTO MZ	1	2	VC	IDE(AT)	751	17	8	(2,7)RLL	1330	17ms	5.0ms	18.4Mb	64KB	60K	6.5W	48-BIT ECC, MZR:3-ZONE
ProDrv-LPS-52S	3.50	1.0"		52.0MB	1219	NONE	AUTO MZ	1	2	VC	SCSI				(2,7)RLL	1330	17ms	5.0ms	16.0Mb	64KB	60K	6.5W	48-BIT ECC, MZR:3-ZONE
ProDrv-LPS-80AT	3.50	1.0"		85.7MB		NONE	AUTO			VC	IDE(AT)	616	17	16									
ProDrv-LPS-80S	3.50	1.0"		85.7MB		NONE	AUTO			VC	SCSI												
PASSPORT XL-105	5.25	HALF		105.0MB	1219	NONE	AUTO	2	4	VC	SCSI				(2,7)RLL		18ms			64KB	250K	8.1W	

MODEL NUMBER	--SIZE--		-----CAPACITY-----		-----PHYSICAL-----						-LOGICAL-			TKS /IN.	--ACCESS--		XFER RATE	POWER USED		COMMENTS
	WTH.	HGT.	UNFORMAT	FORMATED	CYLS	PRE- COMP	LAND S/ ZONE	# PL	RW HD AC	INTER- FACE	CYLS	S/ RW TK HD	RECORD METHOD		AVE. TK/TK	CACHE		MTBF		
PASSPORT XL-120	5.25	HALF		120.0MB	1800	NONE	AUTO	1	2	VC	SCSI-2		(1,7)RLL	17ms	256KB	250K	8.1W			
PASSPORT XL-240	5.25	HALF		240.0MB	1800	NONE	AUTO	2	4	VC	SCSI-2		(1,7)RLL	17ms	256KB	250K	8.1W			
PASSPORT XL-50	5.25	HALF		52.2MB	1219	NONE	AUTO	1	2	VC	SCSI		(2,7)RLL	18ms	64KB	250K	8.1W			
Q-160	5.25	HALF		200.0MB				6	12		SCSI		(2,7)RLL	26ms			10.0Mb			
Q-250	5.25	HALF		53.0MB	823			2	4		SCSI		(2,7)RLL	26ms			10.0Mb			
Q-280	5.25	HALF		80.0MB	823			3	6		SCSI		(2,7)RLL	30ms			10.0Mb			
Q-510	5.25			8.0MB	512	256		17	1	2	ST506/412		(1,3)RLL				5.0Mb			
Q-520	5.25			18.0MB	512	256		17	2	4	ST506/412		(1,3)RLL				5.0Mb			
Q-530	5.25	FULL		27.0MB	512	256		17	3	6	ST506/412		(1,3)RLL	40ms			5.0Mb			
Q-540	5.25	FULL		36.0MB	512	256		17	4	8	ST506/412		(1,3)RLL	45ms			5.0Mb			
RICOH SYSTEMS																				
RH-5130				10.0MB	612	400		17	1	2	ST506/412		(1,3)RLL	85ms			5.0Mb			
RH-5260				10.0MB	615			17	1	2	ST506/412		(1,3)RLL	85ms			5.0Mb			
RH-5261				10.0MB	612			17	1	2	SCSI		(1,3)RLL	85ms			5.0Mb			
RH-5500	5.25	HALF		50.0MB	1285			76	1	2	SCSI		(2,7)RLL	1200	25ms	9.0ms	20K	13.0W	REMOVABLE CARTRIDGE	
RS-9150AR	5.25	HALF		48.7MB	1285		AUTO	76	1	2	SCSI		(2,7)RLL	1200	25ms	9.0ms	20K		REMOVABLE CARTRIDGE	
RMS																				
SS100-S	5.25	HALF		100.0MB			AUTO				SCSI			19ms				SECURESTOR	REMOVABLE CARTRIDGE	
SS140-S	5.25	HALF		142.0MB			AUTO				SCSI			15ms				SECURESTOR	REMOVABLE CARTRIDGE	
SS180-E	5.25	HALF		177.0MB			AUTO				ESDI			15ms				SECURESTOR	REMOVABLE CARTRIDGE	
SS20	5.25	HALF		21.0MB			AUTO				ST506/412		(1,3)RLL	40ms				SECURESTOR	REMOVABLE CARTRIDGE	
SS20-S	5.25	HALF		21.0MB			AUTO				SCSI			40ms				SECURESTOR	REMOVABLE CARTRIDGE	
SS200-S	5.25	HALF		207.0MB			AUTO				SCSI			15ms				SECURESTOR	REMOVABLE CARTRIDGE	
SS320-S	5.25	HALF		320.0MB			AUTO				SCSI			13ms				SECURESTOR	REMOVABLE CARTRIDGE	
SS40	5.25	HALF		42.0MB			AUTO				ST506/412		(1,3)RLL	40ms				SECURESTOR	REMOVABLE CARTRIDGE	
SS40-AT	5.25	HALF		42.0MB			AUTO				IDE(AT)			19ms				SECURESTOR	REMOVABLE CARTRIDGE	
SS400-S	5.25	HALF		42.0MB			AUTO				SCSI			19ms				SECURESTOR	REMOVABLE CARTRIDGE	
SS80-S	5.25	HALF		84.0MB			AUTO				SCSI			19ms				SECURESTOR	REMOVABLE CARTRIDGE	
SS85	5.25	HALF		83.0MB			AUTO				ST506/412		(1,3)RLL	15ms				SECURESTOR	REMOVABLE CARTRIDGE	
SS85-AT	5.25	HALF		83.0MB			AUTO				IDE(AT)			19ms				SECURESTOR	REMOVABLE CARTRIDGE	
RODIME																				

MODEL NUMBER	--SIZE--		-----CAPACITY-----		-----PHYSICAL-----							-LOGICAL-			--ACCESS--		XFER RATE	CACHE	MTBF	POWER USED	COMMENTS		
	WTH.	HGT.	UNFORMAT	FORMATED	CYLS	PRE-COMP	LAND ZONE	S/TK	#PL	RWHD	HDAC	INTER-FACE	CYLS	S/RW	TKHD	RECORD METHOD						TKS /IN.	AVE.
RO-3045	3.50	HALF	45.0MB	37.9MB	872	650	AUTO	17	3	5	VC	ST506/412	(1,3)	RLL		28ms		5.0Mb					
RO-3055	3.50	HALF	54.5MB	45.6MB	872	650	AUTO	17	4	6	VC	ST506/412	(1,3)	RLL	1040	28ms	7.0ms	5.0Mb		20K		9.0W	
RO-3057S	3.50	HALF	55.7MB	45.3MB	680		AUTO		3	5	VC	SCSI	(2,7)	RLL	1040	28ms	7.0ms	7.5Mb		20K		7.0W	
RO-3058A	3.50	HALF	58.0MB	45.3MB	868		AUTO		2	3	VC	IDE(AT)	(2,7)	RLL		18ms		10.0Mb					
RO-3058T	3.50	HALF		45.3MB	868		AUTO		2	3	VC	SCSI	(2,7)	RLL		18ms		10.0Mb					
RO-3059A	3.50	HALF	59.0MB	46.7MB	1216		AUTO		1	2	VC	IDE(AT)	(2,7)	RLL		18ms		10.0Mb					
RO-3059T	3.50	HALF		46.7MB	1216		AUTO		1	2	VC	SCSI	(2,7)	RLL		18ms		12.0Mb					
RO-3060R	3.50	HALF		50.0MB			AUTO				VC	ST506/412	(2,7)	RLL		28ms		7.5Mb					
RO-3065	3.50	HALF	63.6MB	53.1MB	872	650	AUTO	17	4	7	VC	ST506/412	(1,3)	RLL	1040	28ms	7.0ms	5.0Mb		20K		9.0W	
RO-3070S	3.50	HALF		70.0MB			AUTO				VC	SCSI	(2,7)	RLL		28ms							
RO-3071A	3.50	1.0"	71.0MB	60.0MB			AUTO				VC	IDE(AT)	(2,7)	RLL		18ms				64KB			
RO-3075R	3.50	HALF	73.7MB	59.9MB	750	650	AUTO		4	6	VC	ST506/412	(2,7)	RLL	1040	28ms	7.0ms	7.5Mb		20K		9.0W	
RO-3085R	3.50	HALF	86.0MB	69.9MB	750	650	AUTO		4	7	VC	ST506/412	(2,7)	RLL	1040	28ms	7.0ms	7.5Mb		20K		9.0W	
RO-3085S	3.50	HALF	86.0MB	69.9MB	750		AUTO		4	7	VC	SCSI	(2,7)	RLL	1040	28ms	7.0ms	7.5Mb		20K		7.0W	
RO-3088A	3.50	HALF	88.0MB	75.6MB	868		AUTO		3	5	VC	IDE(AT)	(2,7)	RLL		18ms		10.0Mb					
RO-3088T	3.50	HALF	88.0MB	75.6MB	868		AUTO		3	5	VC	SCSI	(2,7)	RLL		18ms		10.0Mb					
RO-3089A	3.50	HALF	89.0MB	70.0MB	1216		AUTO		2	3	VC	IDE(AT)	(2,7)	RLL		18ms		10.0Mb					
RO-3089T	3.50	HALF	89.0MB	70.0MB	1216		AUTO		2	3	VC	SCSI	(2,7)	RLL		18ms		12.0Mb					
RO-3095A	3.50	HALF		80.0MB			AUTO				VC	IDE(AT)	(2,7)	RLL		18ms							
RO-3099A	3.50	HALF	99.0MB	80.0MB			AUTO				VC	IDE(AT)	(2,7)	RLL		19ms				32KB			
RO-3121A	3.50	1.0"		122.0MB			AUTO		2	4	VC	IDE(AT)	(1,7)	RLL		15ms		7.5Mb		64KB	50K	3.8W	
RO-3128A	3.50	HALF	128.0MB	105.8MB	868		AUTO	34	4	7	VC	IDE(AT)	(2,7)	RLL		18ms	5.0ms	10.0Mb		32KB	30K	7.4W	
RO-3128T	3.50	HALF		105.8MB	868		AUTO		4	7	VC	SCSI	(2,7)	RLL		18ms		10.0Mb					
RO-3129A	3.50	HALF	129.0MB	105.8MB	1091		AUTO		3	5	VC	IDE(AT)	(2,7)	RLL		18ms		10.0Mb					
RO-3129T	3.50	HALF		105.8MB	1091		AUTO		3	5	VC	SCSI	(2,7)	RLL		18ms		12.0Mb					
RO-3130S	3.50	HALF	129.8MB	105.0MB	1047		AUTO	30	4	7	VC	SCSI	(2,7)	RLL	1380	22ms	6.0ms	10.0Mb		20K		7.0W	
RO-3135A	3.50	HALF	135.0MB	112.5MB	923		AUTO		4	7	VC	IDE(AT)	(2,7)	RLL		19ms		10.0Mb					
RO-3139AP	3.50	HALF	139.0MB	112.5MB	1168		AUTO	MZ	3	5	VC	IDE(AT)	(2,7)	RLL	1700	18ms		12.0Mb		64KB	100K	10.0W	MZR:2-ZONE
RO-3139S	3.50	HALF	139.9MB	112.5MB	1148	NONE	AUTO		3	5	VC	SCSI-2	(2,7)	RLL	1700	18ms		24.0Mb		64KB	100K	8.5W	
RO-3151A	3.50	HALF	151.0MB	122.0MB			AUTO		2		VC	IDE(AT)	(2,7)	RLL		18ms				64KB			
RO-3259AP	3.50	HALF	259.0MB	213.0MB	1235		AUTO	MZ	5	9	VC	IDE(AT)	(2,7)	RLL	1700	18ms		12.0Mb		64KB	100K	10.0W	MZR:2-ZONE

MODEL NUMBER	--SIZE--		-----CAPACITY-----		-----PHYSICAL-----						-LOGICAL-			RECORD METHOD	TKS /IN.	--ACCESS--		XFER RATE	CACHE	MTBF	POWER USED	COMMENTS
	WTH.	HGT.	UNFORMAT	FORMATED	CYLS	PRE-COMP	LAND ZONE	S/TK	#PL	RWHD	HDAC	INTER-FACE	CYLS			TK	HD					
RO-3259S	3.50	HALF	259.0MB	210.0MB	1189	NONE	AUTO	5	9	VC	SCSI-2			(2,7)RLL	1700	18ms	24.0Mb	64KB	100K	8.5W		
RO-3259T	3.50	HALF	259.0MB	210.0MB			AUTO			VC	SCSI(S)			(2,7)RLL		18ms	32.0Mb	32KB				
RO-3331S	3.50	HALF		333.0MB	1497	NONE	AUTO MZ	4	7	VC	SCSI-2			(1,7)RLL	1905	12ms 3.0ms	21.6Mb	256KB	100K	10.0W	MZR:8-ZONE	
RO-3426S	3.50	HALF		426.0MB	1497	NONE	AUTO MZ	5	9	VC	SCSI-2			(1,7)RLL	1905	12ms 3.0ms	21.6Mb	256KB	100K	10.0W	MZR:8-ZONE	
RO-351	3.50	HALF		5.0MB	306	128		17	1	2	ST506/412			(1,3)RLL		85ms	5.0Mb					
RO-352	3.50	HALF		11.0MB	306	128		17	2	4	ST506/412			(1,3)RLL		85ms	5.0Mb					
RO-3540S	3.50	HALF		540.0MB	1568	NONE	AUTO MZ	6	11	VC	SCSI-2			(1,7)RLL	1905	12ms 3.0ms	21.6Mb	256KB	100K	10.0W	MZR:8-ZONE	
RO-365	3.50	HALF		21.0MB	612			17	2	4	ST506/412			(1,3)RLL			5.0Mb					
RO-652A	3.50	HALF		20.0MB							SCSI					85ms						
RO-652B	3.50	HALF	25.5MB	20.7MB	306		AUTO 33	2	4	SM	SCSI			(2,7)RLL	600	85ms 18.0m	7.5Mb		20K	13.0W		
RO-101	5.25	FULL		6.0MB	192	96		17	1	2	ST506/412			(1,3)RLL			5.0Mb					
RO-102	5.25	FULL		12.0MB	192	96		17	2	4	ST506/412			(1,3)RLL			5.0Mb					
RO-103	5.25	FULL		18.0MB	192	96		17	3	6	ST506/412			(1,3)RLL			5.0Mb					
RO-104	5.25	FULL		24.0MB	192	96		17	4	8	ST506/412			(1,3)RLL			5.0Mb					
RO-200	5.25	FULL		11.0MB	321	132		17	2	4	ST506/412			(1,3)RLL			5.0Mb					
RO-201	5.25	FULL		5.0MB	321	132		17	1	2	ST506/412			(1,3)RLL		85ms	5.0Mb					
RO-201E	5.25	FULL		11.0MB	640	264		17	1	2	ST506/412			(1,3)RLL		55ms	5.0Mb					
RO-202	5.25	HALF		10.0MB	321	132		17	2	4	ST506/412			(1,3)RLL		85ms	5.0Mb					
RO-202E	5.25	FULL		21.0MB	640	264		17	2	4	ST506/412			(1,3)RLL		55ms	5.0Mb					
RO-203	5.25	HALF		15.0MB	321	132		17	3	6	ST506/412			(1,3)RLL		85ms	5.0Mb					
RO-203E	5.25	FULL		32.0MB	640	264		17	3	6	ST506/412			(1,3)RLL		55ms	5.0Mb					
RO-204	5.25	HALF		21.0MB	321	132		17	4	8	ST506/412			(1,3)RLL		85ms	5.0Mb					
RO-204E	5.25	FULL		43.0MB	640	264		17	4	8	ST506/412			(1,3)RLL		55ms	5.0Mb					
RO-251	5.25	HALF		5.0MB	306	128		17	1	2	ST506/412			(1,3)RLL		85ms	5.0Mb					
RO-252	5.25	HALF		11.0MB	306	128		17	2	4	ST506/412			(1,3)RLL		85ms	5.0Mb					
RO-5040S	5.25	HALF		38.0MB					2	3	SCSI			(1,3)RLL		28ms	5.0Mb					
RO-5065	5.25	HALF		63.0MB				17	3	5	ST506/412			(1,3)RLL		28ms	5.0Mb					
RO-5075S	5.25	HALF	76.0MB								SCSI					28ms						
RO-5090	5.25	HALF	89.2MB	74.6MB	1224		AUTO 17	4	7	VC	ST506/412			(1,3)RLL	1100	28ms 5.0ms	5.0Mb		20K	18.0W		
RO-5125E	5.25	HALF	127.4MB	106.5MB	1224		AUTO 34	3	5	VC	ESDI			(2,7)RLL	1100	18ms 4.0ms	10.0Mb		25K	18.0W		
RO-5125S-102	5.25	HALF	126.9MB	102.9MB	1219		AUTO 34	3	5	VC	SCSI			(2,7)RLL	1100	24ms 5.0ms	10.0Mb		20K	18.0W		



MODEL NUMBER	--SIZE--		-----CAPACITY----		-----PHYSICAL-----						--LOGICAL--			--ACCESS--		XFER RATE	CACHE	MTBF	POWER USED	COMMENTS			
	WTH.	HGT.	UNFORMAT	FORMATED	CYLS	PRE-COMP	LAND ZONE	S/TK	# PL	RW HD AC	INTER-FACE	CYLS	S/TK	RW HD	RECORD METHOD						TKS /IN.	AVE. TK/TK	
RO-5125S-1F2	5.25	HALF	126.9MB	102.9MB	1219	AUTO	34	3	5	VC	SCSI				(2,7)RLL	1100	18ms	4.0ms	10.0Mb	20K	18.0W		
RO-5130R	5.25	HALF	133.0MB	114.1MB	1224	AUTO	26	4	7	VC	ST506/412				(2,7)RLL	1100	28ms	5.0ms	7.5Mb	20K	18.0W		
RO-5178S	5.25	HALF		144.2MB	1219	AUTO		4	7	VC	SCSI				(2,7)RLL		19ms		10.0Mb				
RO-5180E	5.25	HALF	178.4MB	149.1MB	1224	AUTO	34	4	7	VC	ESDI				(2,7)RLL	1100	18ms	4.0ms	10.0Mb	25K	18.0W		
RO-5180S-102	5.25	HALF	177.8MB	144.2MB	1219	AUTO	34	4	7	VC	SCSI				(2,7)RLL	1100	24ms	5.0ms	10.0Mb	20K	18.0W		
RO-5180S-1F2	5.25	HALF	177.8MB	144.2MB	1219	AUTO	34	4	7	VC	SCSI				(2,7)RLL	1100	18ms	4.0ms	10.0Mb	20K	18.0W		
RO-752A	5.25	HALF		25.0MB							SCSI						85ms						
RODIME SYSTEMS																							
20 PLUS			20.7MB			NONE		33			SCSI(M)						70ms			30K		MACINTOSH, EXTERNAL	
45 PLUS			40.0MB			NONE		34			SCSI(M)						45ms			30K		MACINTOSH, EXTERNAL	
COBRA 1000e			1000.0MB			NONE	AUTO				VC	SCSI(M)					15ms	15.0Mb	45KB	100K	30.0W	MACINTOSH, EXTERNAL	
COBRA 330e			330.0MB			NONE	AUTO				VC	SCSI(M)			(2,7)RLL		15ms	15.0Mb	45KB	50K	30.0W	MACINTOSH, EXTERNAL	
COBRA 650e			650.0MB			NONE	AUTO				VC	SCSI(M)			(2,7)RLL		17ms	15.0Mb	45KB	50K	30.0W	MACINTOSH, EXTERNAL	
COBRA 100e	3.50	HALF	100.0MB	868		NONE	AUTO		4	7	VC	SCSI(M)			(2,7)RLL		18ms	10.0Mb	16KB	30K	30.0W	MACINTOSH, EXTERNAL	
COBRA 100i	3.50	HALF	100.0MB	868		NONE	AUTO		4	7	VC	SCSI(M)			(2,7)RLL		18ms	10.0Mb	16KB	30K		MACINTOSH	
COBRA 110at	3.50	HALF	110.0MB				AUTO		4		IDE(AT)				(2,7)RLL		20ms		16KB	40K		COMPAQ SETTINGS	
COBRA 110e	3.50	HALF	105.0MB						4		SCSI				(2,7)RLL		18ms			30K			
COBRA 210at	3.50	HALF	210.0MB	1216			AUTO		5	9	VC	IDE(AT)			(2,7)RLL		20ms		48KB	40K		COMPAQ SETTINGS	
COBRA 210e	3.50	HALF	210.0MB	1216		NONE	AUTO		5	9	VC	SCSI(M)			(2,7)RLL		18ms	11.0Mb	48KB	30K	30.0W	MZR:2-ZONE, MACINTOSH, EXTERNAL	
COBRA 210i	3.50	HALF	210.0MB	1216		NONE	AUTO		5	9	VC	SCSI(M)			(2,7)RLL		18ms	11.0Mb	48KB	30K		MZR:2-ZONE, MACINTOSH	
COBRA 40at	3.50	1.0"	42.0MB	1170			AUTO	36	1	2	VC	IDE(AT)			(2,7)RLL		20ms		16KB	40K		COMPAQ SETTINGS	
COBRA 45e	3.50	HALF	40.0MB	868		NONE	AUTO		2	3	VC	SCSI(M)			(2,7)RLL	1380	19ms	10.0Mb	16KB	30K	30.0W	MACINTOSH, EXTERNAL	
COBRA 45i	3.50	HALF	40.0MB	868		NONE	AUTO		2	3	VC	SCSI(M)			(2,7)RLL	1380	19ms	10.0Mb	16KB	30K		MACINTOSH	
COBRA 70e	3.50	HALF	70.0MB	868		NONE	AUTO		3	5	VC	SCSI(M)			(2,7)RLL	1380	18ms	10.0Mb	16KB	30K	30.0W	MACINTOSH, EXTERNAL	
COBRA 70i	3.50	HALF	70.0MB	868		NONE	AUTO		3	5	VC	SCSI(M)			(2,7)RLL	1380	18ms	10.0Mb	16KB	30K		MACINTOSH	
COBRA 80at	3.50	1.0"	84.0MB	1159			AUTO	36	2	4	VC	IDE(AT)			(2,7)RLL		19ms	6.0ms	10.8Mb	16KB	40K	7.5W	COMPAQ SETTINGS
COBRA 650e	5.25		650.0MB				AUTO		15		VC	SCSI					17ms	15.0Mb		50K			
SAMSUNG																							
SD-2040	3.50		42.0MB								ST506/412				(2,7)RLL		30ms						
SHD-3061A	3.50	25.4	60.5MBB	1478		NONE	AUTO	40	1	2	VC	IDE(AT)	977	17	7	(1,7)RLL	16ms	4.0ms	12.5Mb	32KB	200K	3.5W	
SHD-3062A	3.50	25.4	121.0MB	1478		NONE	AUTO	40	2	4	VC	IDE(AT)	917	17	15	(1,7)RLL	16ms	4.0ms	12.5Mb	32KB	200K	3.5W	

MODEL NUMBER	--SIZE--		-----CAPACITY-----		-----PHYSICAL-----							-LOGICAL-			--ACCESS--		XFER RATE	CACHE	MTBF	POWER USED	COMMENTS			
	WTH.	HGT.	UNFORMAT	FORMATED	CYLS	PRE-COMP	LAND ZONE	S/TK	# PL	RW HD AC	INTER-FACE	CYLS	TK	HD	RECORD METHOD	TKS /IN.						AVE. TK/TK		
SHD-3101A	3.50	25.4		105.0MB	1282	NONE	AUTO	40	2	4	VC	IDE(AT)	776	33	8	(1,7)RLL	16ms	4.0ms	12.5Mb	32KB	200K	3.5W		
SEAGATE																								
ST7050P	1.80	10.5	50.0MB	42.0MB		NONE	AUTO	MZ	1	2	VC	PCMCIA				(1,7)RLL	16ms			64KB	250K	0.9W	88-BIT R/S ECC, MZR, 3,545 RPM	
ST7075	1.80	0.5"	75.0MB	65.0MB		NONE	AUTO		2		VC											1.3W		
ST9025A	2.50	0.8"	25.0MB	21.4MB	654		AUTO	32	1	2	VC	IDE(AT)	1024	17	4	(2,7)RLL	20ms	6.0ms		150K	3.0W		3,631 RPM	
ST9038A	2.50	0.8"	38.0MB	32.0MB			AUTO		1	2	VC	IDE(AT)				(2,7)RLL	20ms	6.0ms	12.0Mb	32KB	150K	1.9W	3,546 RPM	
ST9051A	2.50	19.1	51.0MB	42.8MB	654	NONE	AUTO	32	2	4	VC	IDE(AT)	1024	17	6	(2,7)RLL	1750	19ms	6.0ms	10.0Mb	32KB	150K	1.7W	3,631 RPM
ST9052A	2.50	12.5	52.0MB	42.6MB		NONE	AUTO	MZ	1	2	VC	IDE(AT)	980	17	5	(2,7)RLL		16ms	5.0ms	32KB	150K	1.4W	MZR, 3,450 RPM	
ST9077A	2.50	19.5	77.0MB	64.0MB	802	NONE	AUTO	39	2	4	VC	IDE(AT)	669	17	11	(2,7)RLL	1750	19ms	5.0ms	12.0Mb	32KB	150K	1.9W	3,546 RPM
ST9080A	2.50	12.5	80.0MB	65.5MB		NONE	AUTO	MZ	1	2	VC	IDE(AT)	823	38	4	(2,7)RLL	2650	16ms	5.0ms	32KB	150K	1.2W	88-BIT ECC, 3,450 RPM	
ST9096A	2.50	19.1	96.0MB	85.3MB		NONE	AUTO	MZ	2	4	VC	IDE(AT)	980	17	10	(2,7)RLL	2165	16ms	5.0ms	64KB	150K	1.5W	MZR, 3,450 RPM	
ST9096N	2.50	0.8"	96.0MB	85.3MB		NONE	AUTO				VC	SCSI-2				(2,7)RLL	16ms	5.0ms	64KB	150K	2.2W	SEACACHE, 3,450 RPM		
ST9100AG	2.50	12.5	100.0MB	85.3MB		NONE	AUTO	MZ	1	2	VC	IDE(AT)	651	16	16	(1,7)RLL	2650	16ms	5.0ms	120KB	300K	1.2W	MZR, 3,545 RPM	
ST9144A	2.50	19.1	144.0MB	127.9MB		NONE	AUTO	MZ	3	6	VC	IDE(AT)	980	17	15	(2,7)RLL	2165	16ms	5.0ms	64KB	150K	1.5W	MZR, 3,450 RPM	
ST9144N	2.50	0.8"	144.0MB	127.9MB		NONE	AUTO				VC	SCSI-2				(2,7)RLL	16ms	5.0ms	64KB	150K	2.2W	SEACACHE, 3,450 RPM		
ST9145AG	2.50			127.0MB		NONE	AUTO				VC	IDE(AT)												
ST9195A	2.50	0.8"	195.0MB	170.3MB		NONE	AUTO				VC	IDE(AT)	800	32	13	(2,7)RLL		16ms	5.0ms	64KB	150K	1.7W	3,450 RPM	
ST9235AG	2.50	19.1	235.0MB	209.7MB		NONE	AUTO	MZ	3	6	VC	IDE(AT)	985	32	13	(2,7)RLL	2750	16ms	5.0ms	64KB	150K	1.3W	MZR, 3,450 RPM	
ST9235N	2.50	19.1	235.0MB	209.0MB		NONE	AUTO	MZ	3	6	VC	SCSI				(2,7)RLL	2750	16ms	5.0ms	64KB	150K	1.3W	MZR, 3,450 RPM	
ST9295AG	2.50	19.1	295.0MB	261.0MB		NONE	AUTO	MZ			VC	IDE(AT)				(2,7)RLL		16ms	5.0ms	120KB	300K	1.3W	MZR, 3,450 RPM	
ST9295N	2.50	19.1	295.0MB	250.6MB		NONE	AUTO	MZ			VC	SCSI				(2,7)RLL		16ms	5.0ms	64KB	150K	1.3W	MZR, 3,450 RPM	
ST1057A	3.50	HALF	57.0MB	53.4MB	940	NONE	AUTO	MZ	2	3	VC	IDE(AT)	1024	17	6	(2,7)RLL	1300	18ms	6.0ms	10.0Mb	150K	8.0W	MZR:3-ZONE, 3,528 RPM	
ST1057N	3.50	HALF	57.0MB	49.1MB	940	NONE	AUTO	34	2	3	VC	SCSI-2				(2,7)RLL	1300	20ms	8.0ms	10.0Mb	50K	9.0W		
ST1090A	3.50	HALF	90.0MB	79.0MB	1072	NONE	AUTO	29	3	5	VC	IDE(AT)	653	17	14	(2,7)RLL	1350	15ms	4.0ms	8.0Mb	32KB	150K	11.0W	94354-90 SWIFT
ST1090N	3.50	HALF	90.0MB	79.0MB	1068	NONE	AUTO	29	3	5	VC	SCSI				(2,7)RLL	1350	15ms	4.0ms	8.0Mb	32KB	70K	11.0W	94351-90 SWIFT
ST1096N	3.50	HALF	96.0MB	83.9MB	906	NONE	AUTO	26	4	7	VC	SCSI				(2,7)RLL	1300	20ms	8.0ms	7.5Mb	150K	9.0W		
ST1100	3.50	HALF	100.5MB	83.9MB	1072	NONE	AUTO	17	5	9	VC	ST506/412				(1,3)RLL	1350	15ms	4.0ms	5.0Mb	150K	10.0W	94355-100 SWIFT	
ST1102A[-32]	3.50	HALF	102.0MB	89.1MB	965	NONE	AUTO	MZ	3	5	VC	IDE(AT)	1024	17	10	(2,7)RLL	1300	19ms	8.0ms	10.0Mb	32KB	150K	8.0W	MZR:3-ZONE, 3,528 RPM
ST1102N	3.50	HALF	102.0MB	84.0MB	965	NONE	AUTO	MZ	3	5	VC	SCSI-2				(2,7)RLL	1300	20ms	8.0ms	10.0Mb	50K	8.5W	MZR:3-ZONE	
ST1106R	3.50	HALF	106.6MB	91.0MB	977	NONE	AUTO	26	4	7	VC	ST506/412				(2,7)RLL	1900	24ms	8.0ms	7.5Mb	50K	8.0W		
ST1111A	3.50	HALF	111.0MB	98.8MB	1072	NONE	AUTO	36	3	5	VC	IDE(AT)	873	17	13	(2,7)RLL	1350	15ms	4.0ms	10.0Mb	32KB	70K	11.0W	94354-111 SWIFT

MODEL NUMBER	--SIZE--		-----CAPACITY----		-----PHYSICAL-----							-LOGICAL-			--ACCESS--		XFER RATE	CACHE	MTBF	POWER USED	COMMENTS	
	WTH.	HGT.	UNFORMAT	FORMATED	CYLS	PRE-COMP	LAND ZONE	S/TK	# PL	RW HD AC	INTER-FACE	CYLS	S/TK	RW HD	RECORD METHOD	TKS /IN.						AVE.
ST1111E	3.50	HALF	111.9MB	98.8MB	1072	NONE	AUTO	36	3	5	VC	ESDI		(2,7)RLL	1350	15ms	4.0ms	10.0Mb	150K	11.0W	94356-111 SWIFT	
ST1111N	3.50	HALF	111.0MB	98.4MB	1068	NONE	AUTO	36	3	5	VC	SCSI		(2,7)RLL	1350	15ms	4.0ms	10.0Mb	32KB	70K	11.0W	94351-111 SWIFT
ST11200N[D]	3.50	41.4	1248.0MB	1054.0MB	1872	NONE	AUTO	MZ	8	15	VC	SCSI-2F		(1,7)RLL	2150	11ms	2.6ms	31.0Mb	240KB	200K	10.0W	5,411 RPM, MZR
ST11201N[D]	3.50	HALF	1248.0MB	1054.0MB	1872	NONE	AUTO	MZ	8	15	VC	SCSI-2FW		(1,7)RLL	2150	11ms	2.6ms	31.0Mb	240KB	200K	10.0W	5,411 RPM, MZR
ST1126A	3.50	HALF	126.0MB	111.4MB	1072	NONE	AUTO	29	4	7	VC	IDE(AT)	800 17 16	(2,7)RLL	1350	15ms	4.0ms	8.0Mb	32KB	150K	11.0W	94354-126 SWIFT
ST1126N	3.50	HALF	126.0MB	107.0MB	1068	NONE	AUTO	29	4	7	VC	SCSI		(2,7)RLL	1350	15ms	4.0ms	8.0Mb	32KB	150K	11.0W	94351-126 SWIFT
ST1133A	3.50	HALF	133.0MB	117.0MB	1272	NONE	AUTO	36	3	5	VC	IDE(AT)	962 17 14	(2,7)RLL	1350	15ms	4.0ms	10.0Mb	32KB	150K	11.0W	94354-133 SWIFT
ST1133NS	3.50	HALF	133.0MB	113.4MB	1268	NONE	AUTO	36	3	5	VC	SCSI-2		(2,7)RLL	1543	15ms	4.0ms	10.0Mb	32KB	150K	11.0W	94351-133S SWIFT
ST1144A[-32]	3.50	HALF	144.0MB	130.7MB	2048	NONE	AUTO	MZ	4	7	VC	IDE(AT)	1024 17 14	(2,7)RLL	1300	19ms	8.0ms	10.0Mb	8KB	150K	8.5W	MZR:3-ZONE
ST1144N	3.50	HALF	144.0MB	125.8MB	2048	NONE	AUTO	MZ	4	7	VC	SCSI-2		(2,7)RLL	1300	20ms	8.0ms	10.0Mb	8KB	50K	8.5W	MZR:3-ZONE
ST1150R	3.50	HALF	150.7MB	128.4MB	1072	300	AUTO	26	5	9	VC	ST506/412		(2,7)RLL	1350	15ms	4.0ms	7.5Mb	150K	10.0W	94355-150 SWIFT	
ST1156A	3.50	HALF	155.9MB	138.3MB	1072	NONE	AUTO	36	4	7	VC	IDE(AT)	993 17 16	(2,7)RLL	1350	15ms	4.0ms	10.0Mb	32KB	150K	11.0W	94354-155 SWIFT
ST1156E	3.50	HALF	155.9MB	138.3MB	1072	NONE	AUTO	36	4	7	VC	ESDI		(2,7)RLL	1350	15ms	4.0ms	10.0Mb	70K	11.0W	94356-155 SWIFT	
ST1156N	3.50	HALF	155.9MB	137.8MB	1068	NONE	AUTO	36	4	7	VC	SCSI		(2,7)RLL	1350	15ms	4.0ms	10.0Mb	32KB	70K	11.0W	94351-155 SWIFT
ST1156NS	3.50	HALF	156.0MB	137.8MB	1068	NONE	AUTO	36	4	7	VC	SCSI-2		(2,7)RLL	1350	15ms	4.0ms	10.0Mb	70K	11.0W	94351-155S SWIFT	
ST1156R	3.50	HALF	155.9MB	138.3MB	1072	300	AUTO	36	4	7	VC	ST506/412		(2,7)RLL	1350	15ms	4.0ms	7.5Mb	70K	10.0W	94355-156 SWIFT	
ST1162A	3.50	HALF	162.0MB	143.3MB	1072	NONE	AUTO	29	5	9	VC	IDE(AT)	1024 17 16	(2,7)RLL	1350	15ms	4.0ms	8.0Mb	32KB	150K	11.0W	94354-160 SWIFT
ST1162N	3.50	HALF	162.0MB	137.5MB	1068	NONE	AUTO	29	5	9	VC	SCSI		(2,7)RLL	1350	15ms	4.0ms	8.0Mb	32KB	150K	11.0W	94351-160 SWIFT
ST11700N[D]	3.50	41.4	1700.0MB	1430.0MB	2626	NONE	AUTO	MZ	7	13	VC	SCSI-2F		(1,7)RLL		10ms	2.0ms		256KB	500K	9.0W	5,400 RPM, MZR
ST11701N[D]	3.50	41.4	1700.0MB	1430.0MB	2626	NONE	AUTO	MZ	7	13	VC	SCSI-2FW		(1,7)RLL		10ms	2.0ms		256KB	500K	9.0W	5,400 RPM, MZR
ST11750N[D]	3.50	41.4	1745.0MB	1437.0MB	2756	NONE	AUTO	MZ	6	11	VC	SCSI-2F		(1,7)RLL		9ms	0.8ms	46.0Mb	1MB	500K	10.7W	7,200 RPM, MZR
ST11751N[D]	3.50	41.4	1745.0MB	1437.0MB	2756	NOHE	AUTO	MZ	6	11	VC	SCSI-2FW		(1,7)RLL		9ms	0.8ms	46.0Mb	1MB	500K	10.7W	7,200 RPM, MZR
ST1182E	3.50	HALF	182.0MB	161.2MB	972	NONE	AUTO	36	5	9	VC	ESDI		(2,7)RLL								
ST1186A	3.50	HALF	186.0MB	163.8MB	1272	NONE	AUTO	36	4	7	VC	IDE(AT)	880 26 14	(2,7)RLL	1350	15ms	4.0ms	10.0Mb	32KB	150K	11.0W	94354-186 SWIFT
ST1186N	3.50	HALF	186.0MB	158.8MB	1268	NONE	AUTO	36	4	7	VC	SCSI		(2,7)RLL	1543	15ms	4.0ms	10.0Mb	32KB	150K	11.0W	94351-186 SWIFT
ST1186NS	3.50	HALF	186.0MB	158.8MB	1268	NONE	AUTO	36	4	7	VC	SCSI-2		(2,7)RLL	1543	15ms	4.0ms	10.0Mb	32KB	150K	11.0W	94351-186S SWIFT
ST1201A	3.50	HALF	201.0MB	177.5MB	1072	NONE	AUTO	36	5	9	VC	IDE(AT)	954 26 14	(2,7)RLL	1350	15ms	4.0ms	10.0Mb	32KB	150K	11.0W	94354-200 SWIFT
ST1201E	3.50	HALF	201.4MB	177.8MB	1072	NONE	AUTO	36	5	9	VC	ESDI		(2,7)RLL	1350	15ms	4.0ms	10.0Mb	150K	11.0W	94356-200 SWIFT	
ST1201N	3.50	HALF	201.0MB	171.9MB	1068	NONE	AUTO	36	5	9	VC	SCSI		(2,7)RLL	1350	15ms	4.0ms	10.0Mb	32KB	150K	11.0W	94351-200 SWIFT
ST1201NS	3.50	HALF	201.0MB	177.0MB	1068	NONE	AUTO	36	5	9	VC	SCSI-2		(2,7)RLL	1350	15ms	4.0ms	10.0Mb	70K	11.0W	94351-200S SWIFT	
ST1239A	3.50	HALF	239.0MB	210.7MB	1272	NONE	AUTO	36	5	9	VC	IDE(AT)	990 26 16	(2,7)RLL	1543	15ms	4.0ms	10.0Mb	32KB	150K	11.0W	94354-239 SWIFT

MODEL NUMBER	--SIZE--		-----CAPACITY-----		-----PHYSICAL-----							-LOGICAL-			TKS /IN.	--ACCESS--		XFER RATE	CACHE	MTBF	POWER USED	COMMENTS
	WTH.	HGT.	UNFORMAT	FORMATED	CYLS	PRE-COMP	LAND ZONE	S/TK	# PL	RW HD AC	INTER-FACE	CYLS	S/TK	RW HD		RECORD METHOD	AVE. TK/TK					
ST1239N	3.50	HALF	239.0MB	204.2MB	1268	NONE	AUTO	36	5	9	VC	SCSI		(2,7)RLL	1543	15ms	4.0ms	10.0Mb	32KB	150K	11.0W	94351-230 SWIFT
ST1239NS	3.50	HALF	239.0MB	210.3MB	1268	NONE	AUTO	36	5	9	VC	SCSI-2		(2,7)RLL	1543	15ms	4.0ms	10.0Mb	32KB	150K	11.0W	94351-230S SWIFT
ST124	3.50	HALF	25.6MB	21.4MB	615	NONE	670	17	2	4	SM	ST506/412		(1,3)RLL	824	40ms	12.0m	5.0Mb		150K	8.0W	
ST12400N[D]	3.50	41.4	2500.0MB	2100.0MB	2626	NONE	AUTO	MZ	10	19	VC	SCSI-2F		(1,7)RLL		10ms	2.0ms	35.0Mb	256KB	500K	9.0W	5,411 RPM, MZR
ST12401N[D]	3.50	41.4	2500.0MB	2100.0MB	2626	NONE	AUTO	MZ	10	19	VC	SCSI-2FW		(1,7)RLL		10ms	2.0ms	35.0Mb	256KB	500K	9.0W	5,411 RPM, MZR
ST125-0	3.50	HALF	25.6MB	21.4MB	615	NONE	AUTO	17	2	4	SM	ST506/412		(1,3)RLL	824	40ms	8.0ms	5.0Mb		150K	8.0W	
ST125-1	3.50	HALF	25.6MB	21.4MB	615	NONE	AUTO	17	2	4	SM	ST506/412		(1,3)RLL	824	28ms	8.0ms	5.0Mb		150K	8.0W	
ST12550N[D]	3.50	41.4	2547.0MB	2100.0MB	2756	NONE	AUTO	MZ	10	19	VC	SCSI-2F		(1,7)RLL		9ms	0.8ms	46.0Mb	1MB	500K	12.0W	BARRACUDA 2 7,200 RPM, MZR
ST12551N[D]	3.50	41.4	2547.0MB	2100.0MB	2756	NONE	AUTO	MZ	10	19	VC	SCSI-2FW		(1,7)RLL		9ms	0.8ms	46.0Mb	1MB	500K	12.0W	BARRACUDA 2 7,200 RPM, MZR
ST125A-0	3.50	HALF	25.0MB	21.5MB	404	NONE	AUTO	26	2	4	SM	IDE(AT)	615 17 4	(2,7)RLL	824	40ms	8.0ms	7.5Mb		150K	9.0W	
ST125A-1	3.50	HALF	25.0MB	21.5MB	404	NONE	AUTO	26	2	4	SM	IDE(AT)	615 17 4	(2,7)RLL	824	28ms	8.0ms	7.5Mb		150K	9.0W	
ST125N-0	3.50	HALF	25.0MB	21.5MB	407	NONE	AUTO	26	2	4	SM	SCSI		(2,7)RLL	824	40ms	8.0ms	7.5Mb		150K	9.0W	
ST125N-1	3.50	HALF	25.0MB	21.5MB	407	NONE	AUTO	26	2	4	SM	SCSI		(2,7)RLL	824	28ms	8.0ms	7.5Mb		150K	9.0W	
ST1274A	3.50	HALF	274.0MB	230.0MB								IDE(AT)		(2,7)RLL		18ms						
ST137R	3.50	HALF	38.4MB	32.7MB	615	NONE	670	26	2	4	SM	ST506/412		(2,7)RLL	824	40ms	12.0m	7.5Mb		70K	8.3W	
ST138-0	3.50	HALF	38.4MB	32.1MB	615	NONE	AUTO	17	3	6	SM	ST506/412		(1,3)RLL	824	40ms	8.0ms	5.0Mb		150K	8.3W	
ST138-1	3.50	HALF	38.4MB	32.1MB	615	NONE	AUTO	17	3	6	SM	ST506/412		(1,3)RLL	824	28ms	8.0ms	5.0Mb		150K	8.3W	
ST138A-0	3.50	HALF	38.0MB	32.1MB	604	NONE	AUTO	26	2	4	SM	IDE(AT)	615 17 6	(2,7)RLL	824	40ms	8.0ms	7.5Mb		150K	9.0W	
ST138A-1	3.50	HALF	38.0MB	32.1MB	604	NONE	AUTO	26	2	4	SM	IDE(AT)	615 17 6	(2,7)RLL	824	28ms	8.0ms	7.5Mb		150K	9.0W	
ST138N-0	3.50	HALF	38.0MB	32.2MB	615	NONE	AUTO	26	2	4	SM	SCSI		(2,7)RLL	824	40ms	8.0ms	7.5Mb		150K	9.0W	
ST138N-1	3.50	HALF	38.0MB	32.2MB	615	NONE	AUTO	26	2	4	SM	SCSI		(2,7)RLL	824	28ms	8.0ms	7.5Mb		150K	9.0W	
ST138R-0	3.50	HALF	38.4MB	32.7MB	615	NONE	AUTO	26	2	4	SM	ST506/412		(2,7)RLL	824	40ms	8.0ms	7.5Mb		150K	8.3W	
ST138R-1	3.50	HALF	38.4MB	32.7MB	615	NONE	AUTO	26	2	4	SM	ST506/412		(2,7)RLL	824	28ms	8.0ms	7.5Mb		150K	8.3W	
ST1400A	3.50	HALF	381.8MB	331.7MB	1475	NONE	AUTO	MZ	4	7	VC	IDE(AT)	1018 53 12	(1,7)RLL	1760	14ms	2.5ms	21.0Mb	64KB	150K	8.0W	MZR:26-ZONE, 4,412 RPM
ST1400N	3.50	HALF	383.0MB	331.0MB	1476	NONE	AUTO	MZ	4	7	VC	SCSI-2		(1,7)RLL	1760	14ms	2.5ms	21.0Mb	64KB	150K	9.1W	MZR:26-ZONE, 4,412 RPM
ST1401A	3.50	HALF	395.7MB	343.7MB	1132	NONE	AUTO	MZ	5	9	VC	IDE(AT)	726 61 15	(1,7)RLL	1760	12ms	2.5ms	21.0Mb	64KB	150K	8.0W	MZR:26-ZONE, 4,412 RPM
ST1401N	3.50	HALF	390.0MB	338.0MB	1100	NONE	AUTO	MZ	5	9	VC	SCSI-2		(1,7)RLL	1760	12ms	2.5ms	21.0Mb	64KB	150K	9.1W	MZR:26-ZONE, 4,412 RPM
ST1480A	3.50	HALF	490.9MB	426.1MB	1475	NONE	AUTO	MZ	5	9	VC	IDE(AT)	895 62 15	(1,7)RLL	1760	14ms	2.5ms	21.0Mb	64KB	150K	8.0W	MZR:26-ZONE, 4,412 RPM
ST1480N[D]	3.50	HALF	492.0MB	426.0MB	1476	NONE	AUTO	MZ	5	9	VC	SCSI-2		(1,7)RLL	1760	14ms	2.5ms	21.0Mb	64KB	150K	9.1W	MZR:26-ZONE, 4,412 RPM
ST1481N	3.50	HALF	492.0MB	426.0MB	1476	NONE	AUTO	MZ	5	9	VC	SCSI-2F		(1,7)RLL	1760	14ms	2.5ms	21.0Mb	256KB	150K	9.1W	MZR:26-ZONE, 4,412 RPM
ST151	3.50	HALF	50.8MB	42.5MB	977	NONE	AUTO	17	3	5	VC	ST506/412		(1,3)RLL	1300	24ms	8.0ms	5.0Mb		150K	8.0W	

MODEL NUMBER	--SIZE--		-----CAPACITY-----		-----PHYSICAL-----						-LOGICAL-				TKS /IN.	--ACCESS--		XFER RATE	CACHE	MTBF	POWER USED	COMMENTS		
	WTH.	HGT.	UNFORMAT	FORMATED	CYLS	PRE-COMP	LAND ZONE	S/ #	RW HD	INTER-FACE	CYLS	S/ RW	RECORD METHOD	AVE. TK/TK										
ST157A-0	3.50	HALF	57.0MB	44.7MB	560	NONE	AUTO	26	3	6	SM	IDE(AT)	1024	17	5	(2,7)RLL	824	40ms	8.0ms	7.5Mb	2KB	150K	9.0W	
ST157A-1	3.50	HALF	57.0MB	44.7MB	560	NONE	AUTO	26	3	6	SM	IDE(AT)	1024	17	5	(2,7)RLL	824	28ms	8.0ms	7.5Mb	2KB	150K	9.0W	
ST157N-0	3.50	HALF	57.0MB	48.6MB	615	NONE	AUTO	26	3	6	SM	SCSI				(2,7)RLL	824	40ms	8.0ms	7.5Mb	2KB	150K	9.0W	
ST157N-1	3.50	HALF	57.0MB	48.6MB	615	NONE	AUTO	26	3	6	SM	SCSI				(2,7)RLL	824	28ms	8.0ms	7.5Mb	2KB	150K	9.0W	
ST157R-0	3.50	HALF	57.7MB	49.1MB	615	NONE	AUTO	26	3	6	SM	ST506/412				(2,7)RLL	824	40ms	8.0ms	7.5Mb		150k	8.3W	
ST157R-1	3.50	HALF	57.7MB	49.1MB	615	NONE	AUTO	26	3	6	SM	ST506/412				(2,7)RLL	824	28ms	8.0ms	7.5Mb		150K	8.3W	
ST1581N	3.50	HALF	613.0MB	525.0MB	1476	NONE	AUTO	M2	5	9	VC	SCSI-2F				(1,7)RLL	1760	14ms	2.5ms	26.0Mb	256KB	150K	10.0W	4,412 RPM, MZR
ST177N	3.50	HALF	77.0MB	60.8MB	921	NONE	AUTO	26	3	5	VC	SCSI				(2,7)RLL	1300	20ms	8.0ms	7.5Mb		150K	9.0W	
ST1980N [D]	3.50	HALF	1021.0MB	860.0MB	1730	NONE	AUTO	M2	7	13	VC	SCSI-2F				(1,7)RLL	2150	11ms	2.0ms	32.0Mb	240KB	200K	7.0W	5,411 RPM, MZR
ST3025A	3.50	HALF	25.0MB	21.5MB	1616	NONE	AUTO	26	1	1	VC	IDE(AT)	1024	17	8	(2,7)RLL	1760	20ms	8.0ms	12.0Mb		50K	4.0W	
ST3025N	3.50	HALF	25.0MB	21.5MB	1616	NONE	AUTO	26	1	1	VC	SCSI-2				(2,7)RLL	1760	20ms	8.0ms	12.0Mb		50K	4.0W	
ST3051A	3.50	1.0"	51.0MB	43.1MB		NONE	AUTO				VC	IDE(AT)	820	17	6	(2,7)RLL	1792	16ms	3.0ms	15.0Mb	32KB	150K	4.9W	3,211 RPM
ST3057A	3.50	1.0"	57.0MB	49.1MB	940	NONE	AUTO	34	2	3	VC	IDE(AT)	1024	17	8	(2,7)RLL	1760	20ms	8.0ms	12.0Mb		50K	4.0W	
ST3057N	3.50	1.0"	57.0MB	49.1MB	9404	NONE	AUTO	34	2	3	VC	SCSI-2				(2,7)RLL	1760	20ms	8.0ms	12.0Mb		50K	4.0W	
ST3096A	3.50	25.4	96.0MB	89.2MB		NONE	AUTO	35	2	3	VC	IDE(AT)	1024	17	10	(2,7)RLL	1792	14ms	3.0ms	12.0Mb	32KB	150K	2.5W	3,211 RPM
ST3096N	3.50	1.0"	96.0MB	84.0MB	610	NONE	AUTO	35	2	3	VC	SCSI-2				(2,7)RLL	1760	20ms	8.0ms	12.0Mb		50K	4.0W	
ST31200N [D]	3.50	25.4	1200.0MB	1050.0MB	2626	NONE	AUTO	M2	5	9	VC	SCSI-2F				(1,7)RLL		10ms	2.0ms	41.0Mb	256KB	500K	7.0W	MZR, 6,300 RPM
ST3120A	3.50	25.4	120.0MB	106.9MB		NONE	AUTO	M2	2	3	VC	IDE(AT)	1024	17	12	(2,7)RLL	1792	15ms	3.0ms	11.0Mb	32KB	150K	2.5W	MZR:2-ZONE, 3,211 RPM
ST3144A	3.50	25.4	144.0MB	130.6MB		NONE	AUTO	M2	2	3	VC	IDE(AT)	1001	17	15	(2,7)RLL	1791	16ms	3.0ms	12.0Mb	32KB	150K	4.9W	MZR, 3,211 RPM
ST3243A	3.50	25.4	243.0MB	213.9MB		NONE	AUTO	M2			VC	IDE(AT)	1024	34	12	(1,7)RLL		16ms	4.0ms		128KB	150K	4.0W	MZR, 3,811 RPM
ST325A/X	3.50	HALF	25.0MB	21.4MB	697	NONE	AUTO	M2	1	2	SM	IDE-X/A	615	17	4	(2,7)RLL	1290	28ms	7.0ms	13.0Mb		150K	1.8W	MZR:2-ZONE, 3,048 RPM
ST325N	3.50	HALF	25.0MB	21.4MB	654	NONE	AUTO	32	1	2	SM	SCSI				(2,7)RLL	1015	28ms	7.0ms	9.2Mb	2KB	50K	2.7W	
ST325X	3.50	HALF	25.0MB	21.4MB	697	NONE	AUTO	30	1	2		IDE(XT)	615	17	4	(2,7)RLL	1015	45ms	15.0m	9.2Mb		150K	2.0W	
ST3283A	3.50	25.4	283.0MB	245.4MB		NONE	AUTO	M2	3	5	VC	IDE(AT)	978	35	14	(1,7)RLL	1960	12ms	4.0ms	19.8Mb	128KB	200K	4.0W	MZR, 4,500 RPM
ST3283N	3.50	25.4	283.0MB	248.6MB	1689	NONE	AUTO	M2	3	5	VC	SCSI-2F				(1,7)RLL	1960	12ms	4.0ms	19.8Mb	128KB	250K	4.4W	MZR, 4,500 RPM
ST3290A	3.50			260.0MB		NONE	AUTO				VC	IDE(AT)					16ms					250K		
ST3385A	3.50	25.4	385.0MB	340.0MB		NONE	AUTO	M2	3	5	VC	IDE(AT)	767	62	14	(1,7)RLL	2400	12ms	4.0ms	29.0Mb	256KB	250K	4.4W	MZR, 4,500 RPM
ST3390A	3.50			340.0MB		NONE	AUTO				VC	IDE(AT)					12ms					250K		
ST3390N	3.50			340.0MB		NONE	AUTO				VC	SCSI-2					12ms					250K		
ST3500A	3.50	25.4	502.0MB	426.0MB	1547	NONE	AUTO	M2	4	7	VC	IDE(AT)	895	62	15	(1,7)RLL	2150	10ms	2.0ms	28.3Mb	256KB	200K	5.0W	MZR, 4,535 RPM
ST3500N [D]	3.50	1.0"	502.0MB	426.0MB	1547	NONE	AUTO	M2	4	7	VC	SCSI-2F				(1,7)RLL	2150	10ms	2.0ms	26.8Mb	240KB	200K	5.0W	MZR, 4,535 RPM

MODEL NUMBER	--SIZE--		-----CAPACITY----		-----PHYSICAL-----							--LOGICAL--			RECORD METHOD	TKS /IN.	--ACCESS--		XFER RATE	CACHE	MTBF	POWER USED	COMMENTS	
	WTH.	HGT.	UNFORMAT	FORMATED	CYLS	PRE-COMP	LAND ZONE	S/TK	#PL	RW HD AC	INTER-FACE	CYLS	TK	HD			AVE.	TK/TK						
ST351A/X	3.50	HALF	51.0MB	42.8MB		NONE	AUTO	MZ	1	2	SM	IDE-X/A	820	17	6	(2,7)RLL	1290	28ms	7.0ms	12.0Mb		150K	2.0W	MZR:3-ZONE, 3,048 RPM
ST3550A	3.50	25.4	550.0MB	452.4MB		NONE	AUTO	MZ	3	5	VC	IDE(AT)	1018	62	14	(1,7)RLL	2400	12ms	4.0ms	29.0Mb	256KB	250K	4.3W	MZR, 4,500 RPM
ST3550N	3.50	25.4	550.0MB	456.5MB	2126	NONE	AUTO	MZ	3	5	VC	SCSI-2F				(1,7)RLL	2400	12ms	4.0ms	29.0Mb	256KB	250K	4.4W	MZR, 4,500 RPM
ST3600A	3.50	25.4	617.0MB	528.0MB	1872	NONE	AUTO	MZ	4	7	VC	IDE(AT)	1024	63	16	(1,7)RLL	2150	11ms	2.0ms	27.8Mb	256KB	200K	5.0W	MZR, 4,535 RPM
ST3600N [D]	3.50	1.0"	617.0MB	525.0MB	1872	NONE	AUTO	MZ	4	7	VC	SCSI-2F				(1,7)RLL	2150	11ms	2.0ms	26.4Mb	240KB	200K	5.0W	MZR, 4,467 RPM
ST3610N [D]	3.50	1.0"	635.0MB	535.0MB	1872	NONE	AUTO	MZ	4	7	VC	SCSI-2F				(1,7)RLL		11ms	2.0ms	32.3Mb	256KB	200K	5.0W	MZR, 5,411 RPM
ST206	5.25	FULL	6.0MB	5.0MB	306	128		17	1	2	SM	ST506/412				(1,3)RLL				5.0Mb				
ST2106E	5.25	HALF	106.0MB	89.0MB	1024	NONE	AUTO	34	3	5	VC	ESDI				(2,7)RLL	960	18ms	4.0ms	10.0Mb		100K	15.0W	94216-106 WREN 3
ST2106N	5.25	HALF	106.0MB	91.0MB	1022	NONE	AUTO	34	3	5	VC	SCSI				(2,7)RLL	960	18ms	4.0ms	10.0Mb	8KB	100K	18.0W	94211-106 WREN 3
ST212	5.25	FULL	12.76MB	10.0MB	307	128	319	17	2	4	SM	ST506/412				(1,3)RLL	550	65ms	23.0m	5.0Mb		11K	17.0W	
ST2125N	5.25	HALF	125.0MB	106.7MB	1544	NONE	AUTO	MZ	2	3	VC	SCSI				(2,7)RLL	1280	18ms	4.0ms	12.0Mb	32KB	100K	16.0W	MZR, 94221-125/M WREN 5
ST213	5.25	FULL	12.8MB	10.7MB	616	300	670	17	1	2	SM	ST506/412				(1,3)RLL	588	65ms	20.0m	5.0Mb		20K	14.8W	
ST2182E	5.25	HALF	182.0MB	160.7MB	1453	NONE	AUTO	54	3	4	VC	ESDI				(2,7)RLL	1459	16ms	3.0ms	15.0Mb		100K	15.0W	94246-182 WREN 6
ST2209N	5.25	HALF	209.0MB	179.0MB	1544	NONE	AUTO	MZ	3	5	VC	SCSI				(2,7)RLL	1280	18ms	4.0ms	12.0Mb	32KB	100K	16.0W	MZR, 94221-209/M WREN 5
ST224N	5.25	HALF	24.0MB	21.2MB	615	NONE	670	26	1	2	SM	SCSI				(2,7)RLL	588	70ms	20.0m	12.0Mb		100K	16.8W	
ST225	5.25	HALF	25.6MB	21.4MB	615	300	670	17	2	4	SM	ST506/412				(1,3)RLL	588	65ms	20.0m	5.0Mb		100K	14.8W	
ST225N	5.25	HALF	25.5MB	21.3MB	615	NONE	670	17	2	4	SM	SCSI				(1,3)RLL	588	65ms	20.0m	5.0Mb		100K	16.8W	
ST225R	5.25	HALF	25.0MB	21.2MB	667	NONE	670	31	1	2	SM	ST506/412				(2,7)RLL	588	70ms	20.0m	7.5Mb		100K	14.8W	3,000 RPM
ST2274A	5.25	HALF	274.0MB	241.5MB	1747	NONE	AUTO	54	3	5	VC	IDE(AT)	873	36	15	(2,7)RLL	1459	16ms	3.0ms	15.0Mb	32KB	100K	15.0W	94244-274 WREN 6
ST2383A	5.25	HALF	383.0MB	338.1MB	1747	NONE	AUTO	54	4	7	VC	IDE(AT)	873	54	14	(2,7)RLL	1459	16ms	3.0ms	15.0Mb	32KB	100K	15.0W	94244-383 WREN 6
ST2383E	5.25	HALF	383.0MB	337.0MB	1747	NONE	AUTO	54	4	7	VC	ESDI				(2,7)RLL	1459	16ms	3.0ms	15.0Mb		100K	14.0W	94246-383 WREN 6
ST2383N	5.25	HALF	383.0MB	332.0MB	1261	NONE	AUTO	MZ	4	7	VC	SCSI				(2,7)RLL	1459	14ms	3.0ms	20.0Mb	64KB	100K	16.0W	MZR, 94241-383 WREN 6
ST2384A	5.25	HALF	384.0MB	330.0MB								VC IDE(AT)				(2,7)RLL		18ms						
ST238R	5.25	HALF	38.4MB	32.7MB	615	NONE	670	26	2	4	SM	ST506/412				(2,7)RLL	588	65ms	20.0m	7.5Mb		100K	14.8W	
ST2502N	5.25	HALF	502.0MB	435.0MB	1755	NONE	AUTO	MZ	4	7	VC	SCSI				(2,7)RLL	1459	16ms	3.0ms	20.0Mb	64KB	100K	16.0W	MZR, 94241-502 WREN 6
ST250N	5.25	HALF	50.0MB	42.9MB	667	NONE	670	2	4	SM	SCSI					(2,7)RLL	588	70ms	20.0m	7.5Mb		100K	16.8W	
ST250R	5.25	HALF	50.0MB	42.3MB	667	NONE	670	31	2	4	SM	ST506/412				(2,7)RLL	588	70ms	20.0m	7.5Mb		100K	14.8W	3,000 RPM
ST251-0	5.25	HALF	51.2MB	42.8MB	820	NONE	AUTO	17	3	6	SM	ST506/412				(1,3)RLL	777	40ms	8.0ms	5.0Mb		100K	11.0W	
ST251-1	5.25	HALF	51.2MB	42.8MB	820	NONE	AUTO	17	3	6	SM	ST506/412				(1,3)RLL	777	28ms	8.0ms	5.0Mb		100K	12.0W	
ST251N-0	5.25	HALF	51.0MB	43.1MB	820	NONE	AUTO	26	2	4	SM	SCSI				(2,7)RLL	777	40ms	8.0ms	7.5Mb		70K	12.0W	
ST251N-1	5.25	HALF	51.0MB	43.2MB	630	NONE	AUTO	34	2	4	SM	SCSI				(2,7)RLL	777	28ms	8.0ms	10.0Mb		70K	13.0W	

MODEL NUMBER	--SIZE--		-----CAPACITY-----		-----PHYSICAL-----							--LOGICAL--			TKS /IN.	--ACCESS--		XFER RATE	CACHE	MTBF	POWER USED	COMMENTS					
	WTH.	HGT.	UNFORMAT	FORMATED	CYLS	PRE-COMP	LAND ZONE	S/TK	# PL	RW HD	HD AC	INTER-FACE	CYLS	S/TK		RW HD	RECORD METHOD						AVE.	TK/TK			
ST251R	5.25	HALF	51.0MB	43.0MB	820	NONE	820	26	2	4	SM	ST506/412				(2,7)RLL	40ms	7.5Mb									
ST252	5.25	HALF	51.2MB	42.8MB	820	NONE	AUTO	17	3	6	SM	ST506/412				(1,3)RLL	777	40ms 12.0m	5.0Mb	100K	11.0W						
ST253	5.25	HALF	51.5MB	43.0MB	989	128	AUTO	17	3	5	VC	ST506/412				MFM	960	28ms 5.0ms	5.0Mb	40K	20.0W				94205-51	WREN 2	
ST274A	5.25	HALF	74.5MB	65.5MB	948	NONE	AUTO	26	3	5	VC	IDE(AT)	940	17	8	(2,7)RLL	960	29ms 5.0ms	7.5Mb	32KB	40K	20.0W				94204-65,74	WREN 2
ST277N-0	5.25	HALF	77.0MB	64.9MB	820	NONE	AUTO	26	3	6	SM	SCSI				(2,7)RLL	777	40ms 8.0ms	7.5Mb	70K	12.0W						
ST277N-1	5.25	HALF	77.0MB	64.9MB	628	NONE	AUTO	34	3	6	SM	SCSI				(2,7)RLL	777	28ms 8.0ms	10.0Mb	70K	13.0W						
ST277R-0	5.25	HALF	76.9MB	65.5MB	820	NONE	AUTO	26	3	6	SM	ST506/412				(2,7)RLL	777	40ms 8.0ms	7.5Mb	70K	11.0W						
ST277R-1	5.25	HALF	76.9MB	65.5MB	820	NONE	AUTO	26	3	6	SM	ST506/412				(2,7)RLL	777	28ms 8.0ms	7.5Mb	70K	12.0W						
ST278R	5.25	HALF	76.9MB	65.5MB	820	NONE	AUTO	26	3	6	SM	ST506/412				(2,7)RLL	777	40ms 12.0m	7.5Mb	70K	12.0W						
ST279R	5.25	HALF	77.0MB	65.0MB	989	NONE	AUTO	26	3	5	VC	ST506/412				(2,7)RLL	960	28ms 5.0ms	7.5Mb	40K	20.0W				94205-77	WREN 2	
ST280A	5.25	HALF	80.6MB	71.3MB	1032	NONE	AUTO	27	3	5	VC	IDE(AT)	1024	17	8	(2,7)RLL	960	29ms 5.0ms	7.5Mb	32KB	40K	20.0W				94204-71, 94204-81	WREN 2
ST296N	5.25	HALF	96.0MB	84.9MB	820	NONE	AUTO	34	3	6	SM	SCSI				(2,7)RLL	777	28ms 8.0ms	10.0Mb	70K	13.0W						
ST4026	5.25	FULL	25.6MB	21.4MB	615	NONE	AUTO	17	3	4	VC	ST506/412				(1,3)RLL	625	40ms 8.0ms	5.0Mb	15K	25.5W						
ST4038	5.25	FULL	38.2MB	31.9MB	733	300	AUTO	17	3	5	VC	ST506/412				(1,3)RLL	750	40ms 8.0ms	5.0Mb	25K	25.5W						
ST4038M	5.25	FULL	38.2MB	31.9MB	733	NONE	AUTO	17	3	5	VC	ST506/412				(1,3)RLL	750	40ms 8.0ms	5.0Mb	15K	25.5W						
ST4051	5.25	FULL	50.9MB	42.5MB	977	NONE	AUTO	17	3	5	VC	ST506/412				(1,3)RLL	960	40ms 8.0ms	5.0Mb	15K	25.5W						
ST4053	5.25	FULL	53.3MB	44.5MB	1024	NONE	AUTO	17	3	5	VC	ST506/412				(1,3)RLL	1031	28ms 6.0ms	5.0Mb	40K	23.0W						
ST406	5.25	FULL	6.4MB	5.0MB	306	128	319	17	1	2	SM	ST506/412				(1,3)RLL	345	85ms 17.0m	5.0Mb	11K	24.7W						
ST4077N	5.25	FULL	77.0MB	66.9MB	1024		AUTO	26	3	5	VC	SCSI				(2,7)RLL		28ms	7.5Mb								
ST4077R	5.25	FULL	77.0MB	65.0MB	1024			26	3	5		ST506/412				(2,7)RLL		28ms	7.5Mb								
ST4085	5.25	FULL	85.0MB	71.3MB	1024	NONE	AUTO	17	5	8	VC	ST506/412				(1,3)RLL	980	28ms 5.0ms	5.0Mb	40K	28.0W				94155-85	WREN 2	
ST4085p	5.25	FULL	85.0MB	71.3MB	1024	128	AUTO	17	5	8	VC	ST506/412				(1,3)RLL	980	28ms 5.0ms	5.0Mb	40K	28.0W				94155-85p	WREN 2	
ST4086	5.25	FULL	86.0MB	72.5MB	925	NONE	AUTO	17	5	9	VC	ST506/412				(1,3)RLL	960	28ms 5.0ms	5.0Mb	40K	28.0W				94155-86	WREN 2	
ST4086p	5.25	FULL	86.0MB	72.5MB	925	128	AUTO	17	5	9	VC	ST506/412				(1,3)RLL	960	28ms 5.0ms	5.0Mb	40K	28.0W				94155-86p	WREN 2	
ST4096	5.25	FULL	96.0MB	80.2MB	1024	NONE	AUTO	17	5	9	VC	ST506/412				(1,3)RLL	1031	28ms 6.0ms	5.0Mb	40K	23.0W						
ST4096N	5.25	FULL	96.0MB	83.9MB			AUTO					VC	SCSI				17ms										
ST4097	5.25	FULL	96.0MB	80.2MB	1024	NONE	AUTO	17	5	9	VC	ST506/412				(1,3)RLL	980	28ms 5.0ms	5.0Mb	40K	28.0W				94155-96	WREN 2	
ST4097p	5.25	FULL	96.0MB	80.2MB	1024	128	AUTO	17	5	9	VC	ST506/412				(1,3)RLL	980	28ms 5.0ms	5.0Mb	40K	28.0W				94155-96p	WREN 2	
ST41097J	5.25	FULL	1097.0MB		2101	NONE	AUTO		10	17	VC	SMD-O/E					12ms	22.0Mb	150K	44.0W					5,400 RPM		
ST412	5.25	FULL	12.8MB	10.7MB	306	128	319	17	2	4	SM	ST506/412				(1,3)RLL	345	85ms 17.0m	5.0Mb	11K	25.9W						
ST41200N [D] [M]	5.25	FULL	1200.0MB	1037.0MB	1931	NONE	AUTO	MZ	8	15	VC	SCSI-2				(1,7)RLL	1600	15ms 2.5ms	23.8Mb	256KB	150K	24.0W				MZR, 94601-12G/M	WREN 7

MODEL NUMBER	--SIZE--		-----CAPACITY-----		-----PHYSICAL-----							--LOGICAL--			CACHE	MTBF	POWER USED	COMMENTS				
	WTH.	HGT.	UNFORMAT	FORMATED	CYLS	PRE- COMP	LAND ZONE	S/ TK	# PL	RW HD	HD AC	INTER- FACE	CYLS	S/ TK					RW HD	RECORD METHOD	TKS /IN.	---ACCESS---
ST41201J	5.25	FULL	1205.0MB		2101	NONE	AUTO	10	17	VC	SMD-O/E		(2,7)	RLL	1801	12ms	3.0ms	24.0Mb	100K	50.0W	5,400 RPM, 97500-12G ELITE 1	
ST41201K	5.25	FULL	1205.0MB		2101	NONE	AUTO	10	17	VC	IPI-2		(2,7)	RLL	1801	12ms	3.0ms	24.0Mb	100K	50.0W	5,400 RPM, 97509-12G ELITE 1	
ST4135R	5.25	FULL	135.0MB	115.0MB	960	128	AUTO	26	5	9	VC	ST506/412	(2,7)	RLL	980	28ms	5.0ms	7.5Mb	40K	28.0W	94155-135 WREN 2	
ST4144N	5.25	FULL	144.0MB	122.1MB	1024		AUTO	26	5	9	VC	SCSI	(2,7)	RLL				7.5Mb				
ST4144R	5.25	FULL	144.0MB	122.7MB	1024	NONE	AUTO	26	5	9	VC	ST506/412	(2,7)	RLL	1031	28ms	6.0ms	7.5Mb	40K	23.0W		
ST41520N [D]	5.25	FULL	1550.0MB	1352.0MB	2101	NONE	AUTO	MZ	10	17	VC	SCSI-2	(2,7)	RLL	1801	12ms	3.0ms	28.0Mb	256KB	100K	50.0W	MZR, 5,400 RPM, 97501-12G
ST41600N [D]	5.25	FULL	1600.9MB	1370.6MB	2101	NONE	AUTO	MZ	10	17	VC	SCSI-2	(2,7)	RLL		12ms	1.7ms	31.0Mb	256KB	150K	31.6W	MZR, 5,400 RPM, 97501-16G
ST41601N [D]	5.25	FULL	1600.9MB	1370.6MB	2101	NONE	AUTO	MZ	10	17	VC	SCSI-2F	(2,7)	RLL		12ms	1.7ms	31.0Mb	256KB	150K	33.1W	MZR, 5,400 RPM, 97501-16G
ST41650E	5.25	FULL	1650.0MB	1420.0MB			AUTO				VC	ESDI					12ms					
ST41650N [D]	5.25	FULL	1650.0MB	1415.0MB	2107	NONE	AUTO	MZ	8	15	VC	SCSI-2	(1,7)	RLL	1760	15ms	2.5ms	25.0Mb	256KB	150K	21.0W	MZR, WREN 8
ST41651N [D]	5.25	FULL	1650.0MB	1415.0MB	2107	NONE	AUTO	MZ	8	15	VC	SCSI-2F	(1,7)	RLL	1760	15ms	2.5ms	25.0Mb	256KB	150K	21.0W	MZR, WREN 8
ST41800K	5.25	FULL	1800.0MB				AUTO	MZ			VC	IPI-2		RLL		11ms		60.0Mb	250K	23.0W	ELITE 2, 2HP, MZR, 5,400 RPM	
ST4182E	5.25	FULL	182.0MB	151.8MB	969	NONE	AUTO	34	5	9	VC	ESDI	(2,7)	RLL	960	17ms	4.0ms	10.0Mb	100K	21.0W	94166-182 WREN 3	
ST4182N	5.25	FULL	182.0MB	155.0MB	969	NONE	AUTO	35	5	9	VC	SCSI	(2,7)	RLL	960	17ms	4.0ms	10.0Mb	8KB	100K	24.0W	94161-182 WREN 3
ST419	5.25	FULL	19.4MB	15.0MB	306	128	319	17	3	6	SM	ST506/412	(1,3)	RLL	345	85ms	17.0m	5.0Mb	11K	24.7W		
ST4192E	5.25	FULL	192.0MB	169.0MB	1147			36	4	8	ESDI		(2,7)	RLL		17ms		10.0Mb				
ST4192N	5.25	FULL	192.0MB	168.5MB	1147		AUTO	36	5	8	VC	SCSI	(2,7)	RLL	1124	17ms	5.0ms	10.0Mb	25K	25.5W		
ST42000N [D]	5.25	82.6	2106.3MB	1792.1MB	2627	NONE	AUTO	MZ	9	16	VC	SCSI-2F	(1,7)	RLL	2250	11ms	1.7ms	35.0Mb	256KB	150K	29.9W	ELITE 2, MZR, 5,400 RPM
ST42100N [D]	5.25	FULL	2200.0MB	1900.0MB	2573	NONE	AUTO	MZ	8	15	VC	SCSI-2F	(1,7)	RLL	2150	13ms	2.0ms	25.5Mb	256KB	150K	21.0W	WREN 9, MZR
ST42400N [D]	5.25	82.6	2501.2MB	2129.6MB	2627	NONE	AUTO	MZ	11	19	VC	SCSI-2F	(1,7)	RLL	2250	11ms	1.7ms	35.0Mb	256KB	150K	33.0W	ELITE 2, MZR, 5,400 RPM
ST425	5.25	FULL	25.0MB	21.3MB	306	128	319	17	4	8	SM	ST506/412	(1,3)	RLL				5.0Mb				
ST43200K	5.25	FULL	3385.0MB				NONE	AUTO			VC	IPI-2				11ms		87.0Mb	200K	42.0W	ELITE 3, 5,400 RPM	
ST43400N [D]	5.25	82.6	3554.9MB	2916.7MB	2738	NONE	AUTO	MZ	11	20	VC	SCSI-2F	(1,7)	RLL		11ms	1.3ms	43.5Mb	512KB	200K	34.5W	ELITE 3, MZR, 5,400 RPM
ST43401N [D]	5.25	82.6	3554.9MB	2916.7MB	2738	NONE	AUTO	MZ	11	20	VC	SCSI-2FW	(1,7)	RLL		11ms	1.3ms	43.5Mb	512KB	200K	34.5W	ELITE 3, MZR, 5,400 RPM
ST43402ND	5.25	82.6	3554.9MB	2916.7MB	2738	NONE	AUTO	MZ	11	20	VC	SCSI-2FW	(1,7)	RLL		11ms	1.3ms	43.5Mb	512KB	200K	34.5W	ELITE 3, MZR, 5,400 RPM
ST4350N	5.25	FULL	350.0MB	300.0MB	1412	NONE	AUTO	MZ	5	9	VC	SCSI	(2,7)	RLL	1280	17ms	4.0ms	12.0Mb	32KB	100K	27.0W	MZR, 94171-350/M WREN 4
ST4356N	5.25	FULL	356.0MB	311.0MB	1430	NONE	AUTO	MZ	5	9	VC	SCSI	(2,7)	RLL		17ms	4.0ms	12.0Mb	100K			MZR
ST4376N	5.25	FULL	376.0MB	330.0MB	1549	NONE	AUTO	MZ	5	9	VC	SCSI	(2,7)	RLL	1280	18ms	4.0ms	12.0Mb	32KB	100K	27.0W	MZR, 94171-376/M WREN 4
ST4383E	5.25	FULL	383.0MB	319.0MB	1412	NONE	AUTO	34	7	13	VC	ESDI	(2,7)	RLL	1280	18ms	4.0ms	10.0Mb	100K	23.0W	94186-383 WREN 5	
ST4384E	5.25	FULL	383.0MB	319.0MB	1224	NONE	AUTO	34	8	15	VC	ESDI	(2,7)	RLL	1280	15ms	3.0ms	10.0Mb	100K	23.0W	94186-383H WREN 5	
ST4385N [M]	5.25	FULL	385.0MB	330.0MB	791	NONE	AUTO	MZ	8	15	VC	SCSI	(2,7)	RLL	1280	11ms	3.0ms	15.0Mb	32KB	100K	21.0W	MZR, 94181-385H/M WREN 5



MODEL NUMBER	--SIZE--		-----CAPACITY-----		-----PHYSICAL-----						INTER-FACE	-LOGICAL-			RECORD METHOD	TKS /IN.	--ACCESS--		XFER RATE	CACHE	MTBF	POWER USED	COMMENTS
	WTH.	HGT.	UNFORMAT	FORMATED	CYLS	PRE-COMP	LAND ZONE	S/TK	# PL	RW HD AC		CYLS	S/TK	RW HD			AVE.	TK/TK					
ST4442E	5.25	FULL	442.0MB	368.0MB	1412	NONE	AUTO	34	8	15	VC	ESDI	(2,7)RLL	1280	16ms	3.0ms	10.0Mb	100K	23.0W		94186-442 WREN 5		
ST4702N [M]	5.25	FULL	702.0MB	601.0MB	1546	NONE	AUTO	MZ	8	15	VC	SCSI	(2,7)RLL	1280	17ms	3.0ms	14.0Mb	32KB	100K	21.0W		MZR, 94181-702/M WREN 5	
ST4766E	5.25	FULL	766.0MB	664.0MB	1632	NONE	AUTO	53	8	15	VC	ESDI	(2,7)RLL	1459	16ms	4.0ms	15.0Mb	150K	20.0W		94196-766 WREN 6		
ST4766N [M]	5.25	FULL	766.0MB	676.8MB	1632	NONE	AUTO	54	8	15	VC	SCSI	(2,7)RLL	1459	16ms	3.0ms	15.0Mb	32KB	150K	21.0W		94191-766 WREN 6	
ST4767E(S)	5.25	FULL	788.0MB	676.8MB	1399	NONE	AUTO	63	8	15	VC	ESDI	(1,7)RLL	1600	13ms	2.4ms	24.0Mb	150K	27.0W		MZR, 4,800 RPM		
ST4767N [D] [M]	5.25	FULL	767.0MB	665.0MB	1356	NONE	AUTO	64	8	15	VC	SCSI-2	(1,7)RLL	1600	12ms	2.5ms	24.0Mb	256KB	150K	27.0W		4,800 RPM, 94601-767H/M WREN 6	
ST4769E(S)	5.25	FULL	802.0MB	631.0MB	1552	NONE	AUTO	53	8	15	VC	ESDI	(1,7)RLL	1600	12ms	2.5ms	24.0Mb	150K	27.0W		MZR, 4,800 RPM		
ST506	5.25	FULL	6.4MB	5.3MB	153	128	157	17	2	4	SM	ST506	(1,3)RLL	255	85ms	17.0m	5.0Mb	11K	22.7W				
ST706	5.25	FULL	6.0MB	5.0MB	306	128	319	17	1	2	SM	ST506/412	(1,3)RLL				5.0Mb						
ST8100K	8.00	FULL	100.0MB									IPI-2				.2ms	80.0Mb	100K	89.0W		DUAL PORT, SOLID-STATE DISK		
ST81123J	8.00	FULL	1123.0MB		1635	NONE	AUTO		9	15	VC	SMD-O/E	(2,7)RLL	1289	15ms	4.0ms	22.0Mb	100K	95.0W	97200-1130		SABRE1130, DUAL PORT	
ST81154K(T)	8.00	FULL	1154.0MB		1635	NONE	AUTO		9	14	VC	IPI-2	(2,7)RLL	1289	15ms	4.0ms	48.0Mb	100K	115W	97229-1150		SABRE-2HP, DUAL PORT	
ST81236J	8.00	FULL	1236.0MB	1056.0MB	1635	NONE	AUTO		9	15	VC	SMD-O/E	(2,7)RLL	1289	15ms	4.0ms	24.0Mb	100K	95.0W	97200-12G,		SABRE-1.2, DUAL PORT	
ST81236K	8.00	FULL	1236.0MB	1056.0MB	1635	NONE	AUTO		9	15	VC	IPI-2	(2,7)RLL	1289	15ms	4.0ms	24.0Mb	100K	95.0W	97209-12G,		SABRE-1.2, DUAL PORT	
ST81236N	8.00	FULL	1236.0MB	1049.0MB	1635	NONE	AUTO		9	15	VC	SCSI	(2,7)RLL	1289	15ms	4.0ms	24.0Mb	100K	95.0W			97201-12G, SABRE-1.2	
ST8134K	8.00	FULL	134.0MB									IPI-2				.2ms	80.0Mb	100K	92.0W		DUAL PORT, SOLID-STATE DISK		
ST8135K	8.00	FULL	134.0MB									IPI-2				.1ms	150K	98.0W			DUAL PORT, SOLID-STATE DISK		
ST8167K	8.00	FULL	167.0MB									IPI-2				.2ms	80.0Mb	100K	95.0W		DUAL PORT, SOLID-STATE DISK		
ST8201K	8.00	FULL	201.0MB									IPI-2				.1ms	120K	101W			DUAL PORT, SOLID-STATE DISK		
ST82030J	8.00	FULL	2030.0MB				AUTO					VC SMD-O/E				11ms	150K	95.0W			SABRE 6, DUAL PORT		
ST82030K	8.00	FULL	2030.0MB				AUTO					VC IPI-2				11ms	150K	95.0W			SABRE 6, DUAL PORT		
ST82038J	8.00	FULL	2038.0MB		2611	NONE	AUTO		11	19	VC	SMD-E				12ms	19.2Mb	150K	95.0W		DUAL PORT		
ST82105K	8.00	FULL	2105.0MB		2611	NONE	AUTO		11	16	VC	IPI-2	(2,7)RLL	1880	13ms	3.0ms	192Mb	80K	255W			97289-21G SABRE-8HP	
ST82272J	8.00	FULL	2272.0MB		2611	NONE	AUTO		11	19	VC	SMD-E	(2,7)RLL	1880	13ms	3.0ms	22.0Mb	150K	95.0W	97200-23G		SABRE-2.3, DUAL PORT	
ST82368K	8.00	FULL	2368.0MB		2611	NONE	AUTO		18	VC	IPI-2	(2,7)RLL	1880	13ms	3.0ms	218Mb	64K					97299-23G SABRE-23G	
ST82500J	8.00	FULL	2500.0MB	2140.0MB	2611	NONE	AUTO		11	19	VC	SMD-O/E	(2,7)RLL	1880	13ms	3.0ms	24.0Mb	150K	95.0W	97200-25G		SABRE-2.5, DUAL PORT	
ST82500K	8.00	FULL	2500.0MB	2140.0MB	2611	NONE	AUTO		11	19	VC	IPI-2	(2,7)RLL	1880	13ms	3.0ms	24.0Mb	150K	95.0W	97209-25G		SABRE-2.5, DUAL PORT	
ST82500N	8.00	FULL	2500.0MB	2140.0MB	2611	NONE	AUTO		11	19	VC	SCSI	(2,7)RLL	1880	13ms	3.0ms	24.0Mb	150K	95.0W			97201-25G SABRE-2.5	
ST8268K	8.00	FULL	268.0MB									IPI-2				.1ms	100K	104W			DUAL PORT, SOLID-STATE DISK		
ST83050K	8.00	FULL	3050.0MB		2655	NONE	AUTO		11	18	VC	IPI-2				12ms	74.7Mb	150K	110W			DUAL PORT	
ST83220K	8.00	FULL	3220.0MB		2655	NONE	AUTO		11	19	VC	IPI-2				12ms	37.4Mb	150K	95.0W			DUAL PORT	

MODEL NUMBER	--SIZE--		-----CAPACITY-----		-----PHYSICAL-----						-LOGICAL-			RECORD METHOD	TKS /IN.	--ACCESS--		XFER RATE	CACHE	MTBF	POWER USED	COMMENTS
	WTH.	HGT.	UNFORMAT	FORMATED	PRE-CYLS	LAND COMP	S/ZONE	#TK	RW PL	HD AC	INTER-FACE	S/TK	RW/HD			AVE. TK/TK						
ST8335K	8.00	FULL	335.0MB								IPI-2				.1ms			85K	107W		DUAL PORT, SOLID-STATE DISK	
ST833K	8.00	FULL	33.0MB								IPI-2				.2ms	80.0Mb		100K	83.0W		DUAL PORT, SOLID-STATE DISK	
ST8368J	8.00	FULL	368.0MB		1217	NONE	AUTO		10	VC	SMD-E		(2,7)RLL	960	18ms	5.0ms	14.4Mb	30K	85.0W		97200-368, SABRE-368	
ST8368N	8.00	FULL	368.0MB	316.0MB	1217	NONE	AUTO		10	VC	SCSI		(2,7)RLL	960	18ms	5.0ms	14.4Mb	30K	85.0W		97201-368, SABRE-368	
ST8402K	8.00	FULL	402.0MB								IPI-2				.1ms			75K	110W		DUAL PORT, SOLID-STATE DISK	
ST8500J	8.00	FULL	500.0MB		1217	NONE	AUTO		10	VC	SMD-E		(2,7)RLL	960	18ms	5.0ms	19.7Mb	30K	85.0W		97200-500, SABRE-500	
ST8500N	8.00	FULL	500.0MB	378.0MB	1217	NONE	AUTO		10	VC	SCSI		(2,7)RLL	960	18ms	5.0ms	19.2Mb	30K	85.0W		97201-500, SABRE-500	
ST867K	8.00	FULL	67.0MB								IPI-2				.2ms	80.0Mb		100K	86.0W		DUAL PORT, SOLID-STATE DISK	
ST868K	8.00	FULL	67.0MB								IPI-2				.1ms			200K	95.0W		DUAL PORT, SOLID-STATE DISK	
ST8741J	8.00	FULL	736.0MB		1635	NONE	AUTO		15	VC	SMD-E		(2,7)RLL	1289	15ms	4.0ms	14.4Mb	50K	95.0W		97200-736, SABRE-376	
ST8741N	8.00	FULL	736.0MB	637.0MB	1635	NONE	AUTO		15	VC	SCSI		(2,7)RLL	1289	15ms	4.0ms	14.5Mb	50K	95.0W		97201-736, SABRE-736	
ST8851J	8.00	FULL	851.0MB	727.0MB	1381	NONE	AUTO		9	15	VC	SMD-D/E	(2,7)RLL	1089	15ms	4.0ms	19.2Mb	100K	95.0W		97200-850, SABRE-850, DUAL PORT	
ST8851K	8.00	FULL	851.0MB	727.0MB	1381	NONE	AUTO		9	15	VC	IPI-2			15ms	19.2Mb		100K	95.0W		DUAL PORT	
ST8851N	8.00	FULL	851.0MB	727.0MB	1381	NONE	AUTO		9	15	VC	SCSI	(2,7)RLL	1089	15ms	4.0ms	19.2Mb	100K	95.0W		97201-850, SABRE-850	
ST6344J	9.00	FULL	344.0MB		711	NONE	AUTO		7	24	VC	SMD	(1,3)RLL	960	18ms	5.0ms	9.6Mb	30K	225W		97150-340, FSD-340, DUAL HEADS	
ST6516J	9.00	FULL	516.0MB		711	NONE	AUTO		7	24	VC	SMD(-E)	(2,7)RLL	960	18ms	5.0ms	14.4Mb	30K	225W		97150-500, FSD-515, DUAL HEADS	
ST6516K	9.00	FULL	516.0MB		711	NONE	AUTO		7	24	VC	IPI-2			18ms	14.4Mb		30K	225W		DUAL HEAD ASSY	
SHUGART																						
604	5.25	FULL		5.0MB	160	128		17	2	4	SM	ST506/412	(1,3)RLL								5.0Mb	
606	5.25	FULL		7.0MB	160	128		17	3	6	SM	ST506/412	(1,3)RLL								5.0Mb	
612	5.25	FULL		10.0MB	306	128		17	2	4	SM	ST506/412	(1,3)RLL								5.0Mb	
706	5.25	FULL		6.0MB	320	128		17	1	2	SM	ST506/412	(1,3)RLL								5.0Mb	
712	5.25	HALF		10.0MB	320	128		17	2	4	SM	ST506/412	(1,3)RLL								5.0Mb	
SIEMENS																						
1200i	5.25	FULL	207.0MB	174.3MB	1216		AUTO	35	5	8	VC	ESDI	(2,7)RLL	1207	25ms	5.0ms	10.0Mb				30K	30.0W
1300	5.25	FULL	310.0MB	261.4MB	1216		AUTO	35	7	12	VC	ESDI	(2,7)RLL	1207	25ms	5.0ms	10.0Mb				30K	30.0W
2200i	5.25	FULL		174.0MB	1216				4	8		SCSI	(2,7)RLL		25ms		10.0Mb					
2300	5.25	FULL	310.0MB	261.4MB	1216		AUTO	35	7	12	VC	SCSI	(2,7)RLL	1207	25ms	5.0ms	10.0Mb				30K	30.0W
4410	5.25	FULL	382.6MB	334.5MB	1100		AUTO	54	6	11	VC	ESDI	(2,7)RLL	1207	16ms		15.0Mb				40K	27.0W
4420	5.25	FULL	382.6MB	334.5MB	1100		AUTO	54	6	11	VC	SCSI	(2,7)RLL	1207	16ms		16.0Mb				40K	27.0W
5710	5.25	FULL		655.0MB			AUTO		8	15	VC	ESDI	(2,7)RLL		16ms		15.0Mb					

MODEL NUMBER	--SIZE--		-----CAPACITY-----		-----PHYSICAL-----					-LOGICAL-		RECORD METHOD	TKS /IN.	--ACCESS--		XFER RATE	CACHE	MTBF	POWER USED	COMMENTS
	WTH.	HGT.	UNFORMAT	FORMATED	PRE-CYLS	LAND COMP	S/ZONE	#TK	RW PL	HD AC	INTER-FACE			S/TK	RW HD					
5720	5.25	FULL		655.0MB								(2,7)RLL		16ms		15.0Mb				
5810	5.25	FULL	777.0MB									(2,7)RLL	1476	18ms		15.0Mb				
5820	5.25	FULL	777.0MB									(2,7)RLL	1476	18ms		15.0Mb				
6200	5.25		1200.0MB									(2,7)RLL		14ms		10.0Mb	99K			
7520	5.25	FULL		655.0MB								(2,7)RLL		16ms		15.0Mb				
SONY																				
SRD3040A	3.50	HALF		42.9MB													50K			
SRD3040S	3.50	HALF		42.9MB													50K			
SRD4080A	3.50	HALF		85.8MB													50K			
SRD4080S	3.50	HALF		85.8MB													50K			
STORAGE DIMENSIONS																				
MAC195	3.50	HALF		195.0MB								(2,7)RLL		15ms			150K			
PS320S	5.25	FULL	384.0MB	320.0MB	1224							(2,7)RLL	1070	16ms	10.0Mb					MAXTOR XT-4380S PS/2
AT100S	3.50	HALF		105.0MB								(2,7)RLL		19ms			150K			
AT200S	3.50	HALF		204.0MB								(2,7)RLL		15ms			150K			
AT1000S	5.25			1000.0MB										15ms	22.0Mb		100K			
AT120	5.25	FULL	140.0MB	119.9MB	918							(1,3)RLL		27ms	5.0Mb					MAXTOR XT-1140
AT155E	5.25	FULL	180.0MB	156.0MB	1224							(2,7)RLL	1070	14ms	10.0Mb					MAXTOR XT-4170E
AT155S	5.25	FULL	180.0MB	156.0MB	1224							(2,7)RLL	1070	14ms	10.0Mb					MAXTOR XT-4170S
AT100	5.25	FULL	190.0MB	159.8MB	1224							(1,3)RLL		28ms	5.0Mb					MAXTOR XT-2190
AT320S	5.25	FULL	384.0MB	320.0MB	1224							(2,7)RLL	1070	16ms	10.0Mb		100K			MAXTOR XT-4380S
AT335E	5.25	FULL	384.0MB	338.0MB	1224							(2,7)RLL	1070	16ms	10.0Mb					MAXTOR XT-4380E
AT650E	5.25	FULL	768.0MB	651.0MB	1632							(2,7)RLL	1376	16ms	15.0Mb		70K	27.0W		MAXTOR XT-8760E
AT650S	5.25	FULL	768.0MB	651.0MB	1632							(2,7)RLL	1376	16ms	15.0Mb		100K			MAXTOR XT-8760S
PS155E	5.25	FULL	180.0MB	156.0MB	1224							(2,7)RLL	1070	14ms	10.0Mb					MAXTOR XT-4170E PS/2
PS155S	5.25	FULL	180.0MB	156.0MB	1224							(2,7)RLL	1070	14ms	10.0Mb					MAXTOR XT-4170S PS/2
PS335E	5.25	FULL	384.0MB	338.0MB	1224							(2,7)RLL	1070	16ms	10.0Mb					MAXTOR XT-4380E PS/2
PS650S	5.25	FULL	768.0MB	651.0MB	1632							(2,7)RLL	1376	16ms	15.0Mb					MAXTOR XT-8760S PS/2
STORAGE SOLUTIONS																				

MODEL NUMBER	--SIZE--		-----CAPACITY-----		-----PHYSICAL-----					-LOGICAL-			RECORD METHOD	TKS /IN.	--ACCESS--		XFER RATE	CACHE	MTBF	POWER USED	COMMENTS
	WTH.	HGT.	UNFORMAT	FORMATED	PRE-COMP	LAND ZONE	S/TK	# PL	RW HD AC	INTER-FACE	S/TK	RW HD			AVE. TK/TK						
SSI-2000M	3.50		2000.0MB		NONE	AUTO			VC	SCSI-2FW				9ms	120Mb		750K			5,400 RPM	
SYQUEST																					
SQ-2542A	2.50		42.8MB																		
SQ-306RD	5.25		6.0MB	5.0MB	306		17 1 2		ST506/412			(1,3)RLL			5.0Mb						
SQ-312RD	5.25		12.0MB	10.0MB	615		17 1 2		ST506/412			(1,3)RLL			5.0Mb						
SQ-325F	5.25		25.0MB	20.0MB	615		17 2 4		ST506/412			(1,3)RLL			5.0Mb						
SQ-338F	5.25		38.0MB	30.0MB	615		17 3 6		ST506/412			(1,3)RLL			5.0Mb						
SQ-340AF	5.25		38.0MB	640		17 3 6		ST506/412				(1,3)RLL			5.0Mb						
SQ-555	5.25	HALF	44.0MB										25ms							REMOVABLE CARTRIDGES	
SYSGEN																					
MAXI RD45	5.25	HALF	45.0MB				1 2		SCSI			(2,7)RLL		25ms						REMOVABLE CARTRIDGES	
TANDON																					
TM244			41.0MB	782		26 2 4		ST506/412				(2,7)RLL	37ms		7.5Mb						
TM246			62.0MB	782		26 3 6		ST506/412				(2,7)RLL	37ms		7.5Mb						
TM262	3.50	HALF	21.4MB	615		17 2 4		ST506/412				(1,3)RLL	65ms		5.0Mb						
TM262R	3.50	HALF	20.0MB	782		26 1 2		ST506/412				(2,7)RLL	85ms		7.5Mb						
TM264	3.50	HALF	41.0MB	782		26 2 4		ST506/412				(2,7)RLL	85ms		7.5Mb						
TM344	3.50	HALF	41.0MB	782		26 2 4		ST506/412				(2,7)RLL	37ms		7.5Mb						
TM346	3.50	HALF	62.0MB	782		26 3 6		ST506/412				(2,7)RLL	37ms		7.5Mb						
TM362	3.50	HALF	21.4MB	615		17 2 4		ST506/412				(1,3)RLL									
TM362R	3.50	HALF	20.0MB	782		26 1 2		ST506/412				(2,7)RLL	85ms		7.5Mb						
TM364	3.50	HALF	41.0MB	782		26 2 4		ST506/412				(2,7)RLL	85ms		7.5Mb						
TM2085	5.25	FULL	85.0MB	74.0MB	1004		17 5 9		SCSI			(1,3)RLL	25ms		5.0Mb						
TM2128	5.25	FULL	128.0MB	115.0MB	1004		26 5 9		SCSI			(2,7)RLL	25ms		7.5Mb						
TM2170	5.25	FULL	170.0MB	154.0MB	1344		26 5 9		SCSI			(2,7)RLL	25ms		7.5Mb						
TM252	5.25	HALF	10.6MB	306		17 2 4		ST506/412				(1,3)RLL	85ms		5.0Mb						
TM261	5.25	HALF	10.7MB	615		17 1 2		ST506/412				(1,3)RLL			5.0Mb						
TM270	5.25	FULL	71.0MB	1024		17 4 8		ST506/412				(1,3)RLL			5.0Mb						
TM3085	5.25	FULL	85.0MB	71.0MB	1024		17 4 8		ST506/412			(1,3)RLL	37ms		5.0Mb						
TM3085R	5.25	FULL	104.0MB	1024		26 4 8		ST506/412				(2,7)RLL	37ms		7.5Mb						
TM361	5.25	HALF	10.7MB	615		17 1 2		ST506/412				(1,3)RLL			5.0Mb						

MODEL NUMBER	--SIZE--		-----CAPACITY-----		-----PHYSICAL-----						-LOGICAL-			RECORD METHOD	TKS /IN.	--ACCESS--		XFER RATE	CACHE	MTBF	POWER USED	COMMENTS			
	WTH.	HGT.	UNFORMAT	FORMATED	CYLS	PRE-COMP	LAND ZONE	S/TK	#PL	RWHD	HDAC	INTER-FACE	CYLS			TK	HD						AVE.	TK/TK	
TM501	5.25	FULL		5.0MB	306	153		17	1	2	ST506/412		(1,3)	RLL				5.0Mb							
TM502	5.25	FULL		10.0MB	306	153		17	2	4	ST506/412		(1,3)	RLL	85ms			5.0Mb							
TM503	5.25	FULL		15.0MB	306	153		17	3	6	ST506/412		(1,3)	RLL	85ms			5.0Mb							
TM6025	5.25	FULL		5.3MB	153	128		17	2	4	ST506/412		(1,3)	RLL	85ms			5.0Mb							
TM6035	5.25	FULL		8.0MB	153	128		17	3	6	ST506/412		(1,3)	RLL				5.0Mb							
TM6035E	5.25	FULL		12.0MB	230	128		17	3	6	ST506/412		(1,3)	RLL				5.0Mb							
TM702	5.25	FULL		21.4MB	615			17	2	4	ST506/412		(1,3)	RLL				5.0Mb							
TM702AT	5.25	FULL		21.4MB	615			17	2	4	ST506/412		(1,3)	RLL				5.0Mb							
TM703	5.25	FULL		31.9MB	733			17	3	5	ST506/412		(1,3)	RLL				5.0Mb							
TM703AT	5.25	FULL		31.9MB	733			17	3	5	ST506/412		(1,3)	RLL	40ms			5.0Mb							
TM705	5.25	FULL			962																				
TM755	5.25	FULL		43.0MB	981			17	3	5	ST506/412		(1,3)	RLL				5.0Mb							
TANDY																									
25-1045	3.50	HALF	28.0MB																						
25-1046	3.50	HALF	48.0MB	43.2MB	782			27	2	4	SM IDE(XT)		(2,7)	RLL	1021	28ms		7.8Mb		40K	6.9W				
25-1048	3.50	HALF	40.0MB						2		IDE				28ms			12.0Mb							
25-4124	3.50	HALF	52.0MB						2		IDE				17ms			14.0Mb							
25-4130	3.50	HALF	105.0MB						4		IDE		(2,7)	RLL	17ms			14.0Mb							
TEAC																									
SD-3105A	3.50	HALF	105.0MB						4		IDE(AT)				20ms										
SD-3105S	3.50	1.0"	105.0MB						4		SCSI				20ms										
SD-340A	3.50	1.0"	43.0MB	1050		AUTO	40	1	2		IDE(AT)		(2,7)	RLL	1500	23ms	10.0m	7.5Mb	64KB	30K	5.1W		2,358	RPM	
SD-340S	3.50	1.0"	43.0MB	1050		AUTO	40	1	2		SCSI		(2,7)	RLL	1500	23ms	10.0m	7.5Mb	64KB	30K	5.1W		2,358	RPM	
SD-380AT	3.50	1.0"	86.0MB	1050		AUTO		2	4		IDE(AT)		(2,7)	RLL	1500	22ms	10.0m	8.0Mb	64KB	30K	5.1W		2,358	RPM	
SD-380S	3.50	1.0"	86.0MB	1050		AUTO		2	4		SCSI		(2,7)	RLL	1500	22ms	10.0m	8.0Mb	64KB	30K	5.1W		2,358	RPM	
SD-510	5.25	FULL	10.0MB	306	128			17	2	4	ST506/412		(1,3)	RLL				5.0Mb							
SD-520	5.25	FULL	20.0MB	615	300			17	2	4	ST506/412		(1,3)	RLL				5.0Mb							
TEXAS INST.																									
TI-5	5.25	FULL	5.0MB	153				17	2	4	ST506/412		(1,3)	RLL				5.0Mb							
TOSHIBA																									
MK-1422FCV	2.5	12.7	86.0MB	1501	NONE	AUTO	56	1	2	VC	IDE(AT)	988	17	10	2910	15ms	5.0ms	17.6Mb	32KB	150K	1.8W				

MODEL NUMBER	--SIZE--		-----CAPACITY-----		-----PHYSICAL-----						--LOGICAL--			--ACCESS--		XFER RATE	CACHE	MTBF	POWER USED	COMMENTS					
	WTH.	HGT.	UNFORMAT	FORMATED	CYLS	PRE-COMP	LAND ZONE	S/TK	# PL	RW HD	HD AC	INTER-FACE	CYLS	S/TK	RW HD						RECORD METHOD	TKS /IN.	AVE. TK/TK		
MK-1122FC	2.50	19.0		43.0MB			AUTO	1	VC		IDE(AT)				(2,7)RLL		23ms		32KB		2.7W				
MK-2024FC	2.50	19.0		86.0MB	977	NONE	AUTO	43	2	4	VC	IDE(AT)	988	17	10		2000	19ms	5.0ms	12.0Mb	32KB	150K	1.8W	3,200 RPM	
MK-2124FC	2.50	19.0		130.0MB	1155	NONE	AUTO	55	2	4	VC	IDE(AT)	934	17	16		2360	17ms	5.0ms	15.0Mb	32KB	150K	1.8W	3,200 RPM	
MK-2224FC	2.50	19.0		213.0MB	1560	NONE	AUTO	MZ	2	4	VC	IDE(AT)	684	38	16		2840	12ms	3.0ms	25.2Mb	128KB	150K	3.0W	4,000 RPM, MZR:49-83 S/T	
MK-072	3.50	HALF		72.0MB				17				ST506/412				(1,3)RLL		25ms		5.0Mb					
MK-072PCR	3.50	HALF		109.0MB				26				ST506/412				(2,7)RLL		25ms		7.5Mb					
MK-1034FC	3.50	1.0"	124.8MB	106.0MB	1328	NONE	AUTO	39	2	4	VC	IDE(AT)	664	39	9	(2,7)RLL		16ms	6.0ms	10.0Mb	64KB		3.5W		
MK-130	3.50	HALF	53.4MB		733		AUTO	4	7	VC		ST506/412				(1,3)RLL	930	25ms	7.0ms	5.0Mb		30K	10.0W		
MK-134FA(M)	3.50	HALF		45.0MB	733			17	4	7		ST506/412				(1,3)RLL	1000	23ms		5.0Mb		30K	10.0W		
MK-134FA(R)	3.50	HALF		65.0MB	733			26	4	7		ST506/412				(2,7)RLL		23ms		7.5Mb					
MK-232FB	3.50	HALF	53.5MB	45.4MB	845		AUTO	2	3	VC		SCSI				(2,7)RLL	1018	25ms	7.0ms	10.0Mb		30K	10.0W		
MK-233FB	3.50	HALF	89.2MB	75.7MB	845		AUTO	3	5	VC		SCSI				(2,7)RLL	1018	25ms	7.0ms	10.0Mb		30K	10.0W		
MK-234FB	3.50	HALF	124.8MB	106.0MB	845		AUTO	36	4	7	VC	SCSI				(2,7)RLL	1018	25ms	7.0ms	10.0Mb	32KB	30K	10.0W		
MK-234FC(H)	3.50	HALF	124.8MB	106.0MB	845		AUTO	36	4	7	VC	IDE(AT)				(2,7)RLL	1018	25ms	7.0ms	10.0Mb	32KB	30K	10.0W		
MK-438FB	3.50	41.3		877.0MB	1691	NONE	AUTO	8	15	VC		SCSI-2				(1,7)RLL	1745	13ms	2.0ms	24.0Mb	512KB	200K	10.0W		
MK-538FB	3.50	41.3		1230.0MB	1980	NONE	AUTO	8	15	VC		SCSI-2				(1,7)RLL	2055	12ms	2.0ms	31.5Mb	512KB	200K	10.0W		
MK-153FA	5.25	FULL	86.5MB	74.0MB	830		AUTO	35	3	5	VC	ESDI				(2,7)RLL	900	23ms	5.0ms	10.0Mb		30K			
MK-153FB	5.25	FULL	86.5MB	74.0MB	830		AUTO	35	3	5	VC	SCSI				(2,7)RLL	900	23ms	5.0ms	10.0Mb		30K			
MK-154FA	5.25	FULL	121.0MB	104.0MB	830		AUTO	35	4	7	VC	ESDI				(2,7)RLL	900	23ms	5.0ms	10.0Mb		30K			
MK-154FB	5.25	FULL	121.0MB	104.0MB	830		AUTO	35	4	7	VC	SCSI				(2,7)RLL	900	23ms	5.0ms	10.0Mb		30K			
MK-156FA	5.25	FULL	172.9MB	148.0MB	830		AUTO	35	5	10	VC	ESDI				(2,7)RLL	900	23ms	5.0ms	10.0Mb		30K			
MK-156FB	5.25	FULL	172.9MB	148.0MB	830		AUTO	35	5	10	VC	SCSI				(2,7)RLL	900	23ms	5.0ms	10.0Mb		30K	10.0W		
MK-250FA	5.25	FULL	382.5MB		1224		AUTO	35	5	10	VC	ESDI				(2,7)RLL	1330	18ms	5.0ms	15.0Mb		30K			
MK-250FB	5.25	FULL	382.5MB		1224		AUTO	35	5	10	VC	SCSI				(2,7)RLL	1330	18ms	5.0ms	15.0Mb		30K			
MK-353A	5.25	FULL		72.0MB																					
MK-355FA	5.25	FULL	459.0MB		1632		AUTO	53	5	9	VC	ESDI				(2,7)RLL	1330	16ms	4.0ms	15.0Mb		30K			
MK-355FB	5.25	FULL	459.0MB		1632		AUTO	53	5	9	VC	SCSI				(2,7)RLL	1330	16ms	4.0ms	15.0Mb		30K			
MK-358FA	5.25	FULL	765.0MB		1632		AUTO	53	8	15	VC	ESDI				(2,7)RLL	1330	16ms	4.0ms	15.0Mb		30K			
MK-358FB	5.25	FULL	765.0MB		1632		AUTO	53	8	15	VC	SCSI				(2,7)RLL	1330	16ms	4.0ms	15.0Mb		30K			
MK-53FA(M)	5.25	FULL	43.2MB		830	512	AUTO	17	3	5	VC	ST506/412				(1,3)RLL	900	30ms	8.0ms	5.0Mb		20K			
MK-53FA(R)	5.25	FULL	64.8MB		830	512	AUTO	26	3	5	VC	ST506/412				(2,7)RLL	900	30ms	8.0ms	7.5Mb		20K			

MODEL NUMBER	--SIZE--		-----CAPACITY-----		-----PHYSICAL-----							--LOGICAL--			--ACCESS--		XFER RATE	CACHE	MTBF	POWER USED	COMMENTS	
	WTH.	HGT.	UNFORMAT	FORMATED	CYLS	PRE-COMP	LAND ZONE	S/TK	# PL	RW HD AC	INTER-FACE	CYLS	S/TK	RW HD	RECORD METHOD	TKS /IN.						AVE. TK/TK
MK-53FB(M)	5.25	FULL	43.2MB		830	512	AUTO	17	3	5	VC	ST506/412		(1,3)RLL	900	25ms	6.0ms	5.0Mb	20K			
MK-53FB(R)	5.25	FULL	64.8MB		830	512	AUTO	26	3	5	VC	ST506/412		(2,7)RLL	900	25ms	6.0ms	7.5Mb	20K			
MK-54FA(M)	5.25	FULL	60.5MB		830	512	AUTO	17	4	7	VC	ST506/412		(1,3)RLL	900	30ms	8.0ms	5.0Mb	20K			
MK-54FA(R)	5.25	FULL	90.7MB		830	512	AUTO	26	4	7	VC	ST506/412		(2,7)RLL	900	25ms	8.0ms	7.5Mb	20K			
MK-54FB(M)	5.25	FULL	60.5MB		830	512	AUTO	17	4	7	VC	ST506/412		(1,3)RLL	900	25ms	6.0ms	5.0Mb	20K			
MK-54FB(R)	5.25	FULL	90.7MB		830	512	AUTO	26	4	7	VC	ST506/412		(2,7)RLL	900	25ms	6.0ms	7.5Mb	20K			
MK-56FA(M)	5.25	FULL	86.5MB		830	512	AUTO	17	5	10	VC	ST506/412		(1,3)RLL	900	30ms	8.0ms	5.0Mb	20K			
MK-56FA(R)	5.25	FULL	129.8MB		830	512	AUTO	26	5	10	VC	ST506/412		(2,7)RLL	900	30ms	8.0ms	7.5Mb	20K			
MK-56FB(M)	5.25	FULL	86.5MB		830	512	AUTO	17	5	10	VC	ST506/412		(1,3)RLL	900	25ms	6.0ms	5.0Mb	20K			
MK-56FB(R)	5.25	FULL	129.8MB		830	512	AUTO	26	5	10	VC	ST506/412		(2,7)RLL	900	25ms	6.0ms	7.5Mb	20K			
TRADEWINDS																						
PD20-1			20.0MB													23ms				REMOVABLE, FOR DESKTOPS		
PDH20-1			20.0MB													23ms				REMOVABLE, FOR LAPTOPS		
TULIN																						
213	5.25		13.0MB	10.0MB	640			17	1	2		ST506/412		(1,3)RLL				5.0Mb				
226	5.25	HALF	26.0MB	22.0MB	640			17	2	4		ST506/412		(1,3)RLL				5.0Mb				
240	5.25	HALF	40.0MB	33.0MB	640			17	3	6		ST506/412		(1,3)RLL				5.0Mb				
326	5.25		26.0MB	22.0MB	640			17	2	4		ST506/412		(1,3)RLL				5.0Mb				
340	5.25		40.0MB	33.0MB	640			17	3	6		ST506/412		(1,3)RLL				5.0Mb				
VERTEX																						
V130	5.25	FULL	30.0MB	26.0MB	987			17	2	3	VC	ST506/412		(1,3)RLL				5.0Mb		SEE PRIAM V130		
V150	5.25	FULL	50.0MB	43.0MB	987			17	3	5	VC	ST506/412		(1,3)RLL				5.0Mb		SEE PRIAM V150		
V170	5.25	FULL	70.0MB	60.0MB	987			17	4	7	VC	ST506/412		(1,3)RLL				5.0Mb		SEE PRIAM V170		
WESTERN DIGITAL																						
140 ULTRA LITE	1.80		42.0MB			NONE	AUTO					VC	PCMCIA-3			19ms						
170 CAVIAR LITE	2.50		170.0MB			NONE	AUTO					VC				16ms						
WDAB130 TIDBIT	2.50	0.6"	31.9MB	1020		NONE	AUTO	*	1	2	VC	IDE-X/A		(2,7)RLL	1773	19ms	5.0ms	10.1Mb	32KB	50K	3.0W	3,383 RPM,56BIT ECC,MZR:3-ZONE
WDAB260 TIDBIT	2.50	0.8"	62.8MB	1020		NONE	AUTO	*	2	4	VC	IDE-X/A		(2,7)RLL	1773	19ms	5.0ms	10.1Mb	32KB	50K	3.3W	3,383 RPM,56BIT ECC,MZR:3-ZONE
WDAH240 TIDBIT	2.50		42.5MB							1						15ms			32KB			
WDAH280 TIDBIT	2.50		85.2MB							2						15ms			32KB			
WD262	3.50	HALF	21.4MB	615				17	2	4		ST506/412		(1,3)RLL		65ms		5.0Mb				





MODEL NUMBER	--SIZE--		-----CAPACITY----		-----PHYSICAL-----						--LOGICAL--			XFER RATE	CACHE	MTBF	POWER USED	COMMENTS	
	WTH.	HGT.	UNFORMAT	FORMATED	CYLS	PRE-COMP	LAND ZONE	S/TK	# PL	RW HD AC	INTER-FACE	CYLS	S/TK						RW HD
WDAP4105	PIRANH	3.50	HALF	104.9MB					4	IDE(AT)	(2,7)RLL			15ms	40.0Mb	50K			
WDAP4200	PIRANA	3.50	HALF	212.0MB	987	NONE	AUTO	35	12	VC IDE(AT)	(2,7)RLL	1575	13ms	12.6Mb	64KB	50K		3,610 RPM	
WDAP4200	PIRANH	3.50	HALF	212.3MB	1280	NONE	AUTO	41	4	8 VC IDE(AT)	(2,7)RLL	1557	15ms	5.0ms	12.7Mb	64KB	86K	6.0W	56 BIT ECC, 3,610 RPM
WDSC8320	CONDOR	3.50	HALF	320.0MB	949	NONE	AUTO	48	8	14 VC SCSI-2	(1,7)RLL	1202	13ms	4.0ms	16.0Mb	64KB	150K	11.9W	48 BIT ECC, 4,318 RPM
WDSC8320	CONDOR	3.50	HALF	320.0MB			AUTO		8	14 VC SCSI-2	(1,7)RLL	1201	13ms	2.0ms	16.0Mb	64KB	150K	12.0W	4,316 RPM, IBM# 0661-371
WDSC8400	CONDOR	3.50	HALF	400.0MB	1199	NONE	AUTO	48	8	14 VC SCSI-2	(1,7)RLL	1469	12ms	3.0ms	16.0Mb	128KB	150K	11.9W	48 BIT ECC, 4,316 RPM
WDSC8400	CONDOR	3.50	HALF	467.0MB	400.0MB	1201	NONE	AUTO	48	8	14 VC SCSI-2	(1,7)RLL	1469	12ms	2.0ms	16.0Mb	128KB	150K	4,316 RPM, IBM# 0661-467
WDSP2100		3.50	HALF	104.0MB			AUTO		2	VC SCSI-2	(2,7)RLL		15ms	12.7Mb	64KB	50K			
WDSP4105	PIRANH	3.50	HALF	104.9MB					4	SCSI	(2,7)RLL		15ms	40.0Mb		50K			
WDSP4200		3.50	HALF	208.0MB			AUTO		4	VC SCSI-2	(2,7)RLL		15ms	12.7Mb	64KB	50K			
WDSP4200	PIRANH	3.50	HALF	209.8MB	1280	NONE	AUTO	41	4	8 VC SCSI-2	(2,7)RLL	1557	15ms	5.0ms	12.7Mb	64KB	86K	6.0W	56 BIT ECC, 3,610 RPM
WD95024-X		5.25	HALF	21.6MB						SM IDE(XT)	(2,7)RLL		39ms	5.0ms		1KB	50K	6.9W	3:1 INTERLEAVE
WD95028-A		5.25	HALF	20.0MB	782			27	1	2 IDE(AT)	(2,7)RLL		70ms		7.8Mb				
WD95028-AD		5.25	HALF	20.0MB						SM IDE(AT)	(2,7)RLL		69ms						56-BIT ECC, 3:1 INTERLEAVE
WD95028-X		5.25	HALF	20.0MB	782			27	1	2 IDE(XT)	(2,7)RLL		70ms		7.8Mb				
WD95034-X		5.25	HALF	30.0MB						SM IDE(XT)	(2,7)RLL		39ms	5.0ms		1KB	50K	6.9W	3:1 INTERLEAVE
WD95038-X		5.25	HALF	30.0MB	782			27	2	3 IDE(XT)	(2,7)RLL		70ms		7.8Mb				
WD95044-A		5.25	HALF	40.0MB	782			27	2	4 SM IDE(AT)	(2,7)RLL		28ms						1:1 INTERLEAVE
WD95044-X		5.25	HALF	40.0MB						SM IDE(XT)	(2,7)RLL		39ms	5.0ms		1KB	50K	6.9W	3:1 INTERLEAVE
WD95048-A		5.25	HALF	40.0MB	782			27	2	4 IDE(AT)	(2,7)RLL		70ms		7.8Mb				
WD95048-AD		5.25	HALF	40.0MB						SM IDE(AT)	(2,7)RLL		69ms						56-BIT ECC, 3:1 INTERLEAVE
WD95048-X		5.25	HALF	40.0MB	782			27	2	4 IDE(XT)	(2,7)RLL		70ms		7.8Mb				
XEBEC																			
OWL-1		5.25	HALF	25.0MB				17	2	4 SCSI	(1,3)RLL		55ms		5.0Mb				
OWL-11		5.25	HALF	38.0MB				17	2	4 ST506/412	(1,3)RLL		40ms		5.0Mb				
OWL-111		5.25	HALF	52.0MB				17	2	4 SCSI	(1,3)RLL		38ms		5.0Mb				
XEBEC AMERICA																			
XE-3040		3.50		40.0MB				1	2	SM			19ms						
XE-3080		3.50		80.0MB				2	4	SM			19ms						
XE-3120		3.50		120.0MB				3	6	SM			19ms						

HARD DRIVE ABBREVIATIONS		THEREF43	
CYLS .....	TOTAL CYLINDERS	HD AC ....	HEAD ACTUATOR
S/TK .....	SECTORS PER TRACK	TPI .....	TRACKS PER INCH
# PL .....	NUMBER OF PLATTERS	TK/TK .....	TRACK TO TRACK
RW HD .....	# OF READ/WRITE HDS	MZR .....	MULTIPLE ZONE-RECORDING
AVE. ....	AVERAGE ACCESS TIME		
PRE-COMP .	STARTING CYLINDER FOR WRITE PRECOMPENSATION		
Copyright 1989, 1993 F.Robert Falbo, all rights reserved.			
The user is granted permission to distribute this Listing and it's related documentation provided that it is not altered as to content or credit, and it is provided without purpose of monetary gain.			
<p style="text-align: center;">«« DISCLAIMER »»</p> <p>I have strived to make this Listing as accurate as I can, but I realize that mistakes do happen, and so should you. You should consider this Listing as a starting point. I suggest that you use the Manufacturer's Directory to obtain additional information directly before you finalize any decision.</p> <p>My liability shall be limited to only my embarrassment and an appology for any inconvenience caused.</p>			
I may be reached on KADET PCBoard BBS (315)245-3815 (usa). You may also try the Metrolink/Rime "Hardware" & "Harddisk" conferences, and the FidoNet "HDConf" & "OS2HW" Conferences.			
PLEASE DO NOT REQUEST TheRef(tm) ON DISK FROM ME!			
If you know the specs for a hard disk, floppy disk, optical, or controller that's not listed, or have some information you feel should be in the DOC file, send it to me at the address below, and if I include it, you'll get listed in the "Credits" page as a Contributor. (Wow!...International Recognition!) <g>			
Mail all correspondence to:		F. Robert Falbo (THEREF43) 38 Northwinds Manor Rome, NY USA 13440-7314	

# Optical Drive Specs

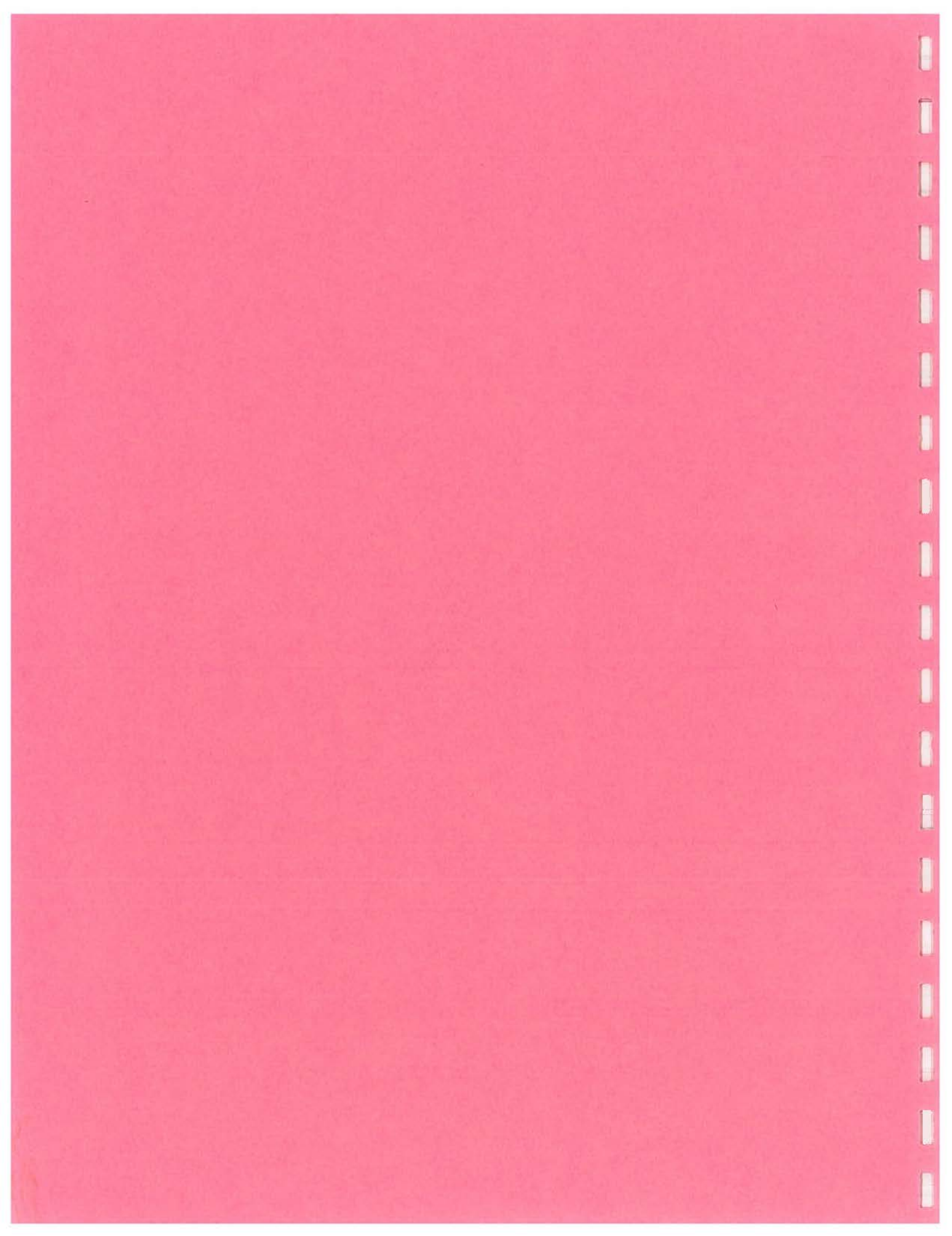

## OPTICAL DRIVE DIRECTORY

THEREF(tm) Version 4.30

05/01/93

MANUFACTURER	MODEL NUMBER	SIZE WIDTH HGT.	UNIT TYPE	FORMATTED CAPACITY	DEVICE INTERFACE	MEDIA TYPE	AUDIO OUTPUTS	AVERAGE ACCESS	LAT- ENCY	TRANS RATE	DATA BUFFER	MTBF	TOTAL POWER	WEIGHT	RECORD MODE	ADDITIONAL INFORMATION	Page 1
A.D.I.C.	DATA OPTIC 600	5.25	WORM	594MB	SCSI			67ms		11.2Mb							
A.D.S.I.	MQO-151	5.25	WORM	594MB	SCSI			95ms		7.4Mb							
A.D.S.I.	MVO-151	5.25	WORM	594MB	SCSI			95ms		7.4Mb							
A.D.S.I.	MZO-151	5.25	WORM	594MB	SCSI			95ms		7.4Mb							
A.D.S.I.	OPTICAL/HSC	5.25	WORM	594MB	SCSI			95ms		7.4Mb							
ACCEL	AEO650	5.25	WORM	650MB	SCSI			95ms		7.4Mb							
ALPHATRONIX	IDQ10-M	5.25	WORM	650MB	Q-BUS			83ms		7.0Mb							
ALPHATRONIX	IDQ20-D,T,S,R	5.25	WORM	1300MB	Q-BUS			83ms		7.0Mb							
ALPHATRONIX	IDU10-M	5.25	WORM	650MB	UNIBUS			83ms		7.0Mb							
ALPHATRONIX	IDU20-D,T,S,R	5.25	WORM	1300MB	UNIBUS			83ms		7.0Mb							
ALPHATRONIX	IMC10-M	5.25	WORM	616MB	SCSI (M)			83ms		7.0Mb							
ALPHATRONIX	IMC20-D,T,S,R	5.25	WORM	1232MB	SCSI (M)			83ms		7.0Mb							
ALPHATRONIX	IPA10-M	5.25	WORM	650MB	XT/AT			83ms		7.0Mb							
ALPHATRONIX	IPA20-D,T,S,R	5.25	WORM	1300MB	XT/AT			83ms		7.0Mb							
ALPHATRONIX	IPN10-M	5.25	WORM	650MB	XT/AT			83ms		7.0Mb							
ALPHATRONIX	IPN20-D,T,S,R	5.25	WORM	1300MB	XT/AT			83ms		7.0Mb							
ALPHATRONIX	IPS10-M	5.25	WORM	650MB	MCA			83ms	12ms	7.0Mb		30K					
ALPHATRONIX	IPS20-D,T,S,R	5.25	WORM	1300MB	MCA			83ms	12ms	7.0Mb		30K					
ALPHATRONIX	ISS10-M	5.25	WORM	592MB	SCSI (S)			83ms		7.0Mb							
ALPHATRONIX	ISS20-D,T,S,R	5.25	WORM	1184MB	SCSI (S)			83ms		7.0Mb							
APPLE	CD SC	5.25 FULL		550MB	SCSI (M)	DISK	YES	600ms								EXTERNAL, STAND ALONE	
ARIX COMP.	RO-5030E	5.25	WORM	652MB	SCSI			67ms		11.2Mb							
CDROM INC.	CRI-1000	5.25 HALF	RO	680MB	SCSI		YES	350ms		1.2Mb	64KB	25K		1182g			
CD TECHNOLOGY	T3201 PORTADRV	5.25 HALF	RO	683MB	SCSI (M)	DISK	YES	350ms	90ms	1.4Mb	64KB	50K				EXTERNAL, STAND ALONE	
CD TECHNOLOGY	T3301 PORTADRV	5.25 HALF	RO	683MB	SCSI (M)		YES	325ms		1.2Mb	64KB	50K		1364g			
CHINON	CDS-355	3.50 29.8	RO	200MB	IDE (AT)	CART.	YES	1500m		1.2Mb	32KB			790g		XA, READS SONY DataDiscman	
CHINON	CDX-355	3.50 36.0	RO	200MB	IDE (AT)	CART.	YES	1500m		1.2Mb	32KB					EXTERNAL, XA, SONY DataDiscman	
CHINON	CDA-431	5.25 HALF	RO	550MB	SCSI (M)		YES	350ms				25K				EXTERNAL, STAND ALONE	
CHINON	CDC-431	5.25 HALF	RO	680MB	SCSI (M)	CART.	YES	350ms		1.2Mb	32KB	25K		2500g		EXTERNAL, STAND ALONE	
CHINON	CDS-431	5.25 HALF	RO	680MB	SCSI	DISK	YES	350ms		1.2Mb	32KB	25K					



MANUFACTURER	MODEL NUMBER	SIZE WIDTH HGT.	UNIT TYPE	FORMATTED CAPACITY	DEVICE INTERFACE	MEDIA TYPE	AUDIO OUTPUTS	AVERAGE ACCESS	LAT- ENCY	TRANS RATE	DATA BUFFER	MTBF	TOTAL POWER	WEIGHT	RECORD MODE	ADDITIONAL INFORMATION
HERSTAL	51000A	5.25	WORM	1000MB	SCSI			35ms								
HEWLETT-PKD.	50720A	5.25 HALF	RO		(PRO.)			500ms					40K			
HEWLETT-PKD.	C1711A	5.25 HALF	M-O	650MB	SCSI	CART.		95ms	13ms	5.4Mb			40K			EXTERNAL, MAGNETO-OPTICAL
HITACHI	CDR-1700S	5.25	RO	600MB	SCSI	DISK		350ms								
HITACHI	CDR-1750S	5.25	RO		SCSI	DISK	YES	320ms	102m	1.2Mb	64KB	20K				EXTERNAL
HITACHI	OD112-L1	5.25 FULL	WORM	644MB	SCSI			62ms	13ms	7.4Mb				3500g		
HITACHI	OD321-1	****	WORM	7000MB	SCSI			120ms	30ms	13.5Mb				27300g		
IBM	MD3125B	3.50 41.3	M-O	128MB	SCSI	CART.		40ms	10ms		256KB	40K	16.1W	750g		INTERNAL, MAGNETO-OPTICAL
IBM	0632-C1A[B,C,G]	5.25 82.5	M-O	650MB	SCSI	CART.		70ms	13ms				60K	33.0W		INTERNAL, MAGNETO-OPTICAL
IBM	PS/2 CDROM II	5.25 HALF	RO	600MB	SCSI	CART.	YES	330ms	103m	1.2Mb	64K	55K		1591g		EXTERNAL
IOMEGA	LASERSAFE	5.25 FULL	M-O		SCSI			67ms					20K			EXTERNAL, MAGNETO-OPTICAL
LASER MAG.	CM-201	5.25 HALF	RO	600MB	IDE	CART.	DIG	500ms		1.2Mb	4KB	34K				
LASER MAG.	CM-212	5.25 HALF	RO	600MB	SCSI	CART.	DIG	400ms		1.2Mb	64KB	40K				
LASER MAG.	CM-221	5.25 HALF	RO	600MB	IDE	CART.	ANL	500ms		1.2Mb	4KB	35K				
LASER MAG.	CM-231	5.25 HALF	RO	600MB	SCSI	CART.	ANL	400ms	107m	1.2Mb	64KB	35K				EXTERNAL
LASER MAG.	LM-510	5.25 FULL	WORM	654MB	SCSI	CART.		61ms	14ms	4.7Mb	64KB	20K				
LASER MAG.	LM-520	5.25 FULL	M-O	654MB	SCSI	CART.		70ms	17ms		256KB	32K		2100g		INT/EXTERNAL, MAGNETO-OPTICAL
LASER MAG.	LD-4100	**** RACK	WORM	5.6GB	SCSI	CART.		80ms	35ms	5.6Mb	1000KB	15K		25000g		2-HEADS, STAND ALONE
LASER MAG.	LF-4500	**** RACK	WORM	28.0GB	SCSI	CART.		80ms	35ms	5.6Mb	1000KB	15K		34000g		2-HEADS, STAND ALONE
LIBERTY SYSTEMS	115CD-P	5.25 HALF	RO	680MB	SCSI		YES	325ms		1.2Mb	64KB	25K				
M.O.S.T.	RMD-5100-S	3.50 HALF	M-O	128MB	SCSI	CART.		35ms	13ms	4.0Mb	64KB	30K	13.5W	1200g	SPIR	SPLIT OPTICS, 88-BIT R/S ECC.
M.O.S.T.	RMD-5200-S	3.50 HALF	M-O	256MB	SCSI	CART.		35ms	12ms	8.0Mb	64KB	30K	13.4W	2000g	ZCAV	SPLIT OPTICS, 88-BIT R/S ECC.
MACSETRA	GENESIS 6000i	5.25	WORM	600MB	SCSI			95ms		5.4Mb						
MAXCESS	M-600L	5.25	WORM	600MB	SCSI			95ms		7.4Mb						
MAXOPTIX	RXT-HD	5.25 FULL	WORM	2.5GB	SCSI	CART.		108ms			256KB	30K	33.0W	2000g		DISK EMULATION
MAXOPTIX	RXT-800HS	5.25 HALF	WORM	393MB, 786M	SCSI	CART.		108ms	60ms	10.0Mb	256KB	30K	30.0W	1400g	CLV	334-668 RPM
MAXOPTIX	TAHITI	5.25 FULL	M-O	652MB, 1GB*	SCSI	CART.		35ms	14ms	*6.8Mb		30K	35.0W	2700g	ZCAV	*ZCAV: 10Mb/s
MAXOPTIX	TAHITI II [D]	5.25 FULL	M-O	650MB, 1GB*	SCSI-2	CART.		35ms	14ms		256KB	30K	35.0W	2700g	ZCAV	*ZCAV, [D] DIF.SCSI OPTION
MAXOPTIX	TAHITI SD [D]	5.25 FULL	M-O	650MB, 1GB*	SCSI-2	CART.		35ms	14ms		256KB	30K	35.0W	2700g	ZCAV	*ZCAV, [D]DIF.SCSI, SUPER H-DUTY
MERIDIAN	100T NETWORK	5.25 HALF	RO			DISK	NO	250ms					40K			IN-SYSTEM UNIT, 14 IN SYSTEM
MICRO DESIGN	LASERBANK 600CD	5.25 HALF	RO	600MB	SCSI	DISK	YES	325ms		1.2Mb	64KB	25K				IN-SYSTEM UNIT
MICRO DESIGN	LASERBANK 600R	5.25 FULL	M-O	650MB	SCSI			65ms	13ms	7.4Mb			25K			INTERNAL/EXTERNAL

MANUFACTURER	MODEL NUMBER	SIZE WIDTH HGT.	UNIT TYPE	FORMATTED CAPACITY	DEVICE INTERFACE	MEDIA TYPE	AUDIO OUTPUTS	AVERAGE ACCESS	LAT- ENCY	TRANS RATE	DATA BUFFER	MTBF	TOTAL POWER	WEIGHT	RECORD MODE	ADDITIONAL INFORMATION
MICRO SOLUTIONS	BACKPACK CDROM	5.25 HALF	RO		LPT1	DISK	YES			1.2Mb	128KB					CONNECTS TO PRINTER PORT
MICRONET	SB-SMO-1	5.25 FULL	M-O					95ms	13ms			40K				INTERNAL/EXTERNAL
MIRROR TECH.	CDR-10	5.25	RO	600MB	SCSI	DISK	YES	350ms								
MITSUBISHI	MW-5D1	5.25 FULL		300MB	ESDI*			63ms	17ms	4.4Mb		20K				*MODIFIED
MITSUBISHI	MW-5U1	5.25 FULL	WORM	300MB	SCSI			68ms	17ms	4.4Mb		20K	45.0W			(5D1 W/SCSI HOST ADAPTER)
MITSUBISHI	RM600	5.25	WORM	594MB	SCSI			61ms		3.6Mb						
N/HANCE SYS.	R6501mce-DOS	5.25	WORM	650MB	SCSI			95ms		7.4Mb						
N/HANCE SYS.	R6501mce-LAN	5.25	WORM	650MB	SCSI			95ms		7.4Mb						
N/HANCE SYS.	R6501mce-OS/2	5.25	WORM	650MB	SCSI			95ms		7.4Mb						
N/HANCE SYS.	R6501sce-DOS	5.25	WORM	650MB	SCSI			95ms		7.4Mb						
N/HANCE SYS.	R6501sce-LAN	5.25	WORM	650MB	SCSI			95ms		7.4Mb						
N/HANCE SYS.	R6501sce-MAC	5.25	WORM	650MB	SCSI			95ms		7.4Mb						
N/HANCE SYS.	R6501sci-DOS	5.25	WORM	650MB	SCSI			95ms		7.4Mb						
NEC	CDR-35	5.25	RO													
NEC	CDR-36	5.25 HALF	RO	680MB	SCSI	DISK	YES	500ms		1.2Mb	64KB	10K		1000g		PORTABLE, EXTERNAL
NEC	CDR-72	5.25	RO													
NEC	CDR-73	5.25 HALF	RO	680MB	SCSI	DISK	YES	300ms	55ms	1.2Mb	64KB	20K		3500g		EXTERNAL
NEC	CDR-74	5.25 HALF	RO	680MB	SCSI		YES	280ms		2.4Mb	64KB	20K				
NEC	CDR-82	5.25	RO													
NEC	CDR-83	5.25 HALF	RO	680MB	SCSI	DISK		300ms		1.2Mb		20K		1400g		
OCEAN MICRO	VISTA V256	3.50 41.3	M-O	256MB	SCSI-2	CART.	NO	48ms	13ms	4.0Mb		30K	13.4W	2000g		EXTERNAL, DUAL MEDIA
OCEAN MICRO	TIDALWAVE 650	5.25 FULL	M-O	650MB	SCSI			95ms	13ms			30K				EXTERNAL
ONLINE PROD.	OPC-OSU-202	5.25 HALF	RO	600MB	SCSI,P	DISK	NO	350ms								EXT., 2 OR 4, PRO.FMT:500ms
PANASONIC	LF-5010	5.25 FULL	WORM	400MB,940MB	SCSI-2	CART.		90ms	25ms	5.6Mb		20K		6400g		OPTIONAL 50-DISK JUKEBOX
PANASONIC	LF-7010	5.25 HALF	WORM	1000MB	SCSI-2	CART.		90ms		10.3Mb		20K		6400g		EXTERNAL, DIRECT OVERWRITE
PANASONIC	LF-7014	5.25 HALF	WORM	1000MB	SCSI-2	CART.		90ms		10.3Mb		20K		2500g		DIRECT OVERWRITE
PANASONIC	LK-MC5015	5.25 HALF	RO	540MB			YES	380ms		1.2Mb	64KB	25K				EXTERNAL
PERIPHERAL LAND	INFINITY	5.25 HALF	M-O					73ms	13ms			20K				INTERNAL/EXTERNAL
PERIPHERAL LAND	PLI CD-ROM	5.25	RO		SCSI	DISK	YES	380ms	92ms	1.2Mb	64KB	25K				EXTERNAL
PINNACLE	REO-130	3.50 HALF	WORM	128MB	SCSI,M	DISK	OPT	28ms	13ms	4.3Mb	256KB	20K	17.0W	2000g	CAV	INTERNAL/EXTERNAL STAND ALONE
PINNACLE	REO-6500	5.25 FULL	RMRM	650MB	SCSI,M	CART.	OPT	65ms	13ms	5.4Mb	64KB	20K	60.0W	20500g	CAV	EXTERNAL, 10-DISK JUKEBOX
PINNACLE	REO-1300	5.25 FULL	WORM	2x650MB	SCSI,M	CART.	OPT	65ms	13ms	5.4Mb	64KB	20K		10900g	CAV	EXTERNAL, 2 DISKS



MANUFACTURER	MODEL NUMBER	SIZE WIDTH HGT.	UNIT TYPE	FORMATTED CAPACITY	DEVICE INTERFACE	MEDIA TYPE	AUDIO OUTPUTS	AVERAGE ACCESS	LAT- ENCY	TRANS RATE	DATA BUFFER	MTBF	TOTAL POWER	WEIGHT	RECORD MODE	ADDITIONAL INFORMATION
PINNACLE	REO-36000	5.25 FULL	WORM	2x650MB	SCSI,M	CART.	OPT	65ms	13ms	5.4Mb	64KB	20K	400W	70000g	CAV	EXTERNAL, 56-DISK JUKEBOX
PINNACLE	REO-650	5.25 FULL	M-O	650MB	SCSI,M	DISK	OPT	65ms		5.4Mb		20K				INTERNAL/EXTERNAL STAND ALONE
PIONEER	DD-M5101	5.25 HALF	WORM	654MB	IDI	CART.		60ms	17ms	5.9Mb			24.0W	1900g	CAV	
PIONEER	DD-U5001	5.25 FULL		654MB	SCSI	CART.		60ms	17ms	5.9Mb			16.0W	1900g		
PIONEER	DD-U5101	5.25 FULL	WORM	654MB	SCSI	CART.		60ms	17ms	5.9Mb			43.0W	6000g	CAV	WITH IDE/SCSI ADAPTER
PIONEER	DE-S7001	5.25 HALF	WORM	654MB	SCSI	CART.		53ms	17ms	3.9Mb	256KB		35.0W	6500g		EXTERNAL
PIONEER	DE-U7001	5.25 FULL	WORM	654MB	IDI	CART.		53ms	17ms	3.9Mb	256KB		35.0W	2100g		
PIONEER	DRM-600	5.25 FULL	RO	6x540MB	SCSI	DISK	YES	600ms		1.2Mb			15.0W	5300g		EXTERNAL, 6-DISK JUKEBOX
PIONEER	DRM-604X	5.25 FULL	RO	6x540MB	SCSI					4.8Mb						EXT, 6-DISK JUKEBOX, 4X SPEED
PIONEER	DD-8001	8.00 FULL	WORM	750MB, 1500M	SCSI	CART.		250ms		5.3Mb	256KB		64.0W	19000g		EXTERNAL
PIONEER	DJ-1	8.00	WORM	20x1500MB	SCSI	CART.		250ms		5.3Mb	512KB		250W	108kg		EXTERNAL, 20-CART. AUTOCHANGER
PIONEER	CLD-M90	****	RO													
PROCOM TECH.	MCDRom 650	5.25 HALF	RO		SCSI,M	DISK	YES	350ms			64KB	25K				EXTERNAL STAND ALONE
PROCOM TECH.	Meod 650	5.25 FULL	M-O	650MB				95ms				20K				EXTERNAL
PROCOM TECH.	PXCD650S	5.25	RO		PROPRI.	DISK	YES	350ms	92ms	1.2Mb	8KB	25KB				EXTERNAL
PROCOM TECH.	SxCDs	5.25 HALF	RO	650MB	PROPRI.		YES	380ms		1.2Mb	64KB	10K				EXTERNAL
PROCOM TECH.	SiCDs	5.25 HALF	RO	650MB	PROPRI.		YES	380ms		1.2Mb	64KB	10K				
REFERENCE	500AT DUAL SCSI	5.25 HALF	RO		SCSI	DISK	OPT	500ms			64KB	10K				EXTERNAL, DUAL DRIVES
REFERENCE	500AT EXT.	5.25 HALF	RO		(PRO.)	DISK	OPT	500ms			64KB	10K				EXTERNAL STAND ALONE
REFERENCE	500AT EXT. SCSI	5.25 HALF	RO		SCSI	DISK	OPT	500ms			64KB	10K				EXTERNAL STAND ALONE
REFERENCE	500AT INT.	5.25 HALF	RO		(PRO.)	DISK	OPT	500ms			64KB	10K				
REFERENCE	500AT INT. SCSI	5.25 HALF	RO		SCSI	DISK	OPT	500ms			64KB	10K				
REFERENCE	500PS2 EXT.	5.25 HALF	RO		(PRO.)	DISK	OPT	500ms			64KB	10K				EXTERNAL STAND ALONE
REFERENCE	500PS2 EXT. SCSI	5.25 HALF	RO		SCSI	DISK	OPT	500ms			64KB	10K				EXTERNAL STAND ALONE
RELAX TECH.	25-2160	5.25	WORM	570MB	SCSI			65ms	17ms	3.6Mb		20K				INTERNAL/EXTERNAL
RICOH	RO-5030E II	5.25 FULL	WORM	594MB, 652M	SCSI	CART.		67ms	INC.	3.6Mb	256KB	20K	33.0W	3000g		512/1024 BYTES PER SECTOR
RICOH	RO-5031E	5.25 FULL	M-O	594MB	SCSI1/2	CART.		37ms		2.0Mb	256KB	30K				
RICOH	RS-9100H	5.25 HALF	WORM	800MB	SCSI	CART.		168ms	INC.	2.5Mb	256KB	30K				2048 BYTES PER SECTOR
RICOH	RS-9200E II	5.25 FULL	WORM	594MB, 652M	SCSI	CART.		67ms	INC.	5.6Mb	256KB	18K	45.0W	6000g		512/1024 BYTES PER SECTOR
SHARP	JY-7000	5.25 FULL	M-O					60ms				30K				EXTERNAL
SONY	RMO-S350	3.50 HALF	M-O	128MB	SCSI-2	CART.		40ms	10ms	7.3Mb	64KB	40K	66.0W	4500G	CAV	EXTERNAL
SONY	RMO-S550	5.25 FULL	M-O	650MB	SCSI	CART.		70ms	13ms	5.4Mb	64KB	40K	78.0W	5400g	CAV	EXT, 512/1024 BYTES/SECTOR

MANUFACTURER	MODEL NUMBER	SIZE WIDTH HGT.	UNIT TYPE	FORMATTED CAPACITY	DEVICE INTERFACE	MEDIA TYPE	AUDIO OUTPUTS	AVERAGE ACCESS	LAT- ENCY	TRANS RATE	DATA BUFFER	MTBF	TOTAL POWER	WEIGHT	RECORD MODE	ADDITIONAL INFORMATION
SONY	SMO-P301	3.50 HALF	M-O	128MB	SCSI	CART.		40ms	10ms	5.0Mb	64KB		14.0W	1100g	CAV	
SONY	CDU-535	5.25 HALF	RO		IDE(AT)	DISK	YES	340ms	92ms	1.2Mb	8KB	25K				
SONY	CDU-541	5.25 HALF	RO		SCSI	DISK	YES	380ms	92ms	1.2Mb	64KB	25K				
SONY	CDU-6205	5.25	RO		IDE(AT)	DISK	YES	340ms	92ms	1.2Mb	8KB	25K				EXTERNAL
SONY	CDU-6211	5.25	RO		SCSI	DISK	YES	380ms	92ms	1.2Mb	64KB	25K				EXTERNAL
SONY	CDU-7211	5.25 HALF	RO	680MB	SCSI		YES	280ms		1.2Mb	256KB	25K				EXTERNAL
SONY	SMO-D501/C501	5.25 FULL	WORM	650MB	SCSI	CART.		95ms	13ms	5.4Mb	64KB		17.0W	3000g	CAV	
SONY	SMO-E501	5.25 FULL	M-O	650MB	SCSI	CART.		70ms	13ms	7.4Mb	64KB		17.0W	2500g	CAV	
SONY	SMO-E511	5.25 FULL	M-O	650MB	SCSI	CART.		70ms	13ms	7.4Mb	64KB		17.0W	2500g	CAV	
SONY	SMO-S501/C501	5.25 FULL	WORM	650MB	SCSI	CART.		70ms	13ms	5.4Mb	64KB		17.0W	6500g	CAV	EXTERNAL
SONY	WDD-600	**** FULL	WORM	6.55G/4.36G	PROPR.	CART.		180ms		4.8Mb					*	*CAV/CLV
STOR. DIMEN.	LNE1-1000AT	5.25	WORM	650MB,900MB	SCSI			49ms		4.0Mb						
STOR. DIMEN.	LSE1-1000AT	5.25	WORM	650MB,900MB	SCSI			49ms		4.0Mb						
STOR. DIMEN.	MCE880-HC1	5.25	WORM	650MB,900MB	SCSI			49ms		4.0Mb						
STOR. SOLUTIONS	OPTA-STOR 5.25	5.25	M-O					70ms	13ms			20K				INTERNAL/EXTERNAL
SUMMUS	SO-600	5.25	WORM	594MB	SCSI			90ms		5.0Mb						
SUMO SYSTEMS	RSSM600-C (PC)	5.25	WORM	594MB	SCSI	CART.		50ms		9.6Mb		20K	33.0W	4700g		EXTERNAL STANDALONE
SUMO SYSTEMS	RSSM600-DQ(DEC)	5.25	WORM	594MB	SCSI	CART.		50ms		9.6Mb		20K	33.0W	4700g		EXTERNAL STANDALONE
SUMO SYSTEMS	RSSM600-S (SUN)	5.25	WORM	594MB	SCSI(S)	CART.		50ms		9.6Mb		20K	33.0W	4700g		EXTERNAL STANDALONE
SUN MOON	CDR-3600U															
SUN MOON	SYST. 286-12 CD															
TANDY	CDR-1000	5.25	RO		PROPRI.	DISK	YES	999ms		1.2Mb		10K				
TEAC	OD-3000	3.50 HALF	M-O	128MB	SCSI-2	CART		42ms	10ms	5.1Mb	128KB	30K	11.0W	600g		REED/SOLOMON ECC
TECMAR	LASERVAULT	5.25	WORM	650MB	SCSI			95ms		5.5Mb						
TEXEL	DM-3011	5.25 HALF	RO		SCSI	DISK	NO	340ms		1.5Mb	64KB	30K		1200g		LINEAR MOTOR HEAD ACTUATOR
TEXEL	DM-3021	5.25 HALF	RO	680MB	SCSI	DISK	YES	340ms		1.5Mb	64KB	30K		1200g		LINEAR MOTOR HEAD ACTUATOR
TEXEL	DM-3024	5.25 HALF	RO	680MB	SCSI		YES	265ms		2.4Mb	64KB	30K				
TEXEL	DM-3111	5.25 HALF	RO		SCSI	DISK	NO	700ms		1.5Mb	64KB	10K		1200g		SCREW TYPE HEAD ACTUATOR
TEXEL	DM-3121	5.25 HALF	RO		SCSI	DISK	YES	700ms		1.5Mb	64KB	10K		1200g		SCREW TYPE HEAD ACTUATOR
TEXEL	DM-5011	5.25 HALF	RO		SCSI	DISK	NO	340ms		1.5Mb	64KB	30K		2700g		EXTERNAL, LINEAR ACTUATOR
TEXEL	DM-5021	5.25 HALF	RO	680MB	SCSI	DISK	YES	340ms		1.5Mb	64KB	30K		2700g		EXTERNAL, LINEAR ACTUATOR
TEXEL	DM-5024	5.25 HALF	RO	680MB	SCSI		YES	265ms		2.4Mb	64KB	30K				EXTERNAL

MANUFACTURER	MODEL NUMBER	SIZE WIDTH HGT.	UNIT TYPE	FORMATTED CAPACITY	DEVICE INTERFACE	MEDIA TYPE	AUDIO OUTPUTS	AVERAGE ACCESS	LAT- ENCY	TRANS RATE	DATA BUFFER	MTBF	TOTAL POWER	WEIGHT	RECORD MODE	ADDITIONAL INFORMATION
TEXEL	DM-5111	5.25 HALF	RO		SCSI	DISK	NO	700ms		1.5Mb	64KB	10K		2700g		EXTERNAL, SCREW TYPE ACTUATOR
TEXEL	DM-5121	5.25 HALF	RO		SCSI	DISK	YES	700ms		1.5Mb	64KB	10K		2700g		EXTERNAL, SCREW TYPE ACTUATOR
TOSHIBA	WM-070	5.25 FULL	WORM	900MB	SCSI			90ms								
TOSHIBA	XM-3100B	5.25 HALF	RO	600MB	SCSI	CATR.		350ms		1.2Mb	64KB				CLV	
TOSHIBA	XM-3101B	5.25 HALF	RO	600MB	SCSI	CART.	YES	350ms		1.2Mb	64KB				CLV	
TOSHIBA	XM-3201A1-MAC	5.25 HALF	RO	600MB	SCSI (M)		YES	350ms			64KB	25K				EXTERNAL, MAC SCSI INTERFACE
TOSHIBA	XM-3201A1-PCF	5.25 HALF	RO	600MB	SCSI		YES	350ms			64KB	25K				EXTERNAL
TOSHIBA	XM-3201A1-PS2	5.25 HALF	RO	600MB	SCSI		YES	350ms			64KB	25K				EXTERNAL, FOR PS/2
TOSHIBA	XM-3201B	5.25 HALF	RO	683MB	SCSI	CART.	YES	350ms			64KB	25K				
TOSHIBA	XM-3301-E1-PCF	5.25 HALF	RO	683MB	SCSI	DISK	YES	325ms	55ms	1.2Mb	64KB	30K				FOR AT TYPE SYSTEMS
TOSHIBA	XM-3301-E1-PS2	5.25 HALF	RO	683MB	SCSI	DISK	YES	325ms	55ms	1.2Mb	64KB	30K				FOR PS/2 TYPE SYSTEMS
TOSHIBA	XM-5100A-MAC	5.25 HALF	RO	599MB,683MB	SCSI (M)	CART.	YES	380ms			64KB	10K				EXTERNAL, MAC SCSI INTERFACE
TOSHIBA	XM-5100A-PCF	5.25 HALF	RO	599MB,683MB	SCSI	CART.	YES	380ms			64KB	10K				EXTERNAL
TOSHIBA	XM-5100A-PS2	5.25 HALF	RO	599MB,683MB	SCSI	CART.	YES	380ms			64KB	10K				EXTERNAL, FOR PS/2
TOSHIBA	WM-500	**** RACK	WORM	5000MB	SCSI	CART.		160ms								EXTERNAL, 19" RACK MOUNT
TRIMARCHI	LASERACE	5.25	WORM	600MB	SCSI			45ms		9.6Mb						
TRISTAR	PE3660-1D	5.25	WORM	600MB	SCSI			61ms		9.6Mb						
TRISTAR	PE3660-1DQ	5.25	WORM	600MB	Q-BUS			61ms		9.6Mb						
TRISTAR	PE3660-1R	5.25	WORM	600MB	SCSI			61ms		9.6Mb						
TRISTAR	PE3660-2R	5.25	WORM	1200MB	SCSI			61ms		9.6Mb						
US DESIGN	QD1000-Q	5.25	WORM	650MB,1000M	Q-BUS			35ms		12.0Mb						
US DESIGN	QD1000-S	5.25	WORM	650MB,1000M	SCSI (S)			35ms		12.0Mb						
US DESIGN	QD1000-U	5.25	WORM	650MB,1000M	UNIBUS			35ms		12.0Mb						
US DESIGN	QT1000-Q	5.25	WORM	650MB,1000M	Q-BUS			35ms		12.0Mb						
US DESIGN	QT1000-S	5.25	WORM	650MB,1000M	SCSI (S)			35ms		12.0Mb						
US DESIGN	QT1000-U	5.25	WORM	650MB,1000M	UNIBUS			35ms		12.0Mb						
XYXIS	XY600RW	5.25	WORM	574MB	SCSI			61ms		9.6Mb						
ZETACO	SKR-600	5.25	WORM	650MB	SCSI			95ms		5.0Mb						

## OPTICAL DRIVE ABBREVIATIONS

THEREF43

TYPE ... R/W FUNCTIONS	FMT,D CAP . FORMATTED CAPACITY
MEDIA .. MEDIA FORMAT	ACC ..... AVE. ACCESS TIME
XFER ... TRANSFER RATE	INTERF .... DEVICE INTERFACE
AUDIO .. AUDIO SUPPORT	H.A. .... HOST ADAPTER
RO ..... READ ONLY	ECC ... ERROR CORECTION CODE
PRO .... PROPRIETARY	WORM .. WRITE ONCE, READ MANY
M ..... MAC COMPATIBLE	WORM .. WRITE MANY, READ MANY
ZCAV ... ZONED CONSTANT ANGULAR VELOCITY	

Copyright 1990,1993 F.Robert Falbo, all rights reserved.

The User is granted permission to distribute this Listing and it's related documentation, provided that it is not altered as to content or credit, and it is provided without purpose of monetary gain.

«« DISCLAIMER »»

I have strived to make this Listing as accurate as I can, but I realize that mistakes do happen, and so should you. You should consider this Listing as a starting point. I suggest that you use the Manufacturer's Directory to obtain additional information directly before you finalize any decision.

My liability shall be limited to only my embarrassment and an appology for any inconvenience caused.

I may be reached on KADET PCBoard BBS (315)245-3815 (USA). You may also try the Metrolink/Rime "Hardware" & "Harddisk" conferences, or the FidoNet "HDConf" & "OS2HW" conferences.

PLEASE DO NOT REQUEST TheRef(tm) ON DISK FROM ME!

If you know the specs of a hard disk, floppy disk, optical, or controller that's not listed, or have some information you feel should be in the DOC file, send it to me at the address below, and if I include it, you'll get listed in the "Credits" page as a Contributor. (Wow!...International Recognition!) <g>

Mail all correspondence to:

F. Robert Falbo  
 (THEREF43)  
 38 Northwinds Manor  
 Rome, NY USA 13440-7314

# Manufacturer Directory

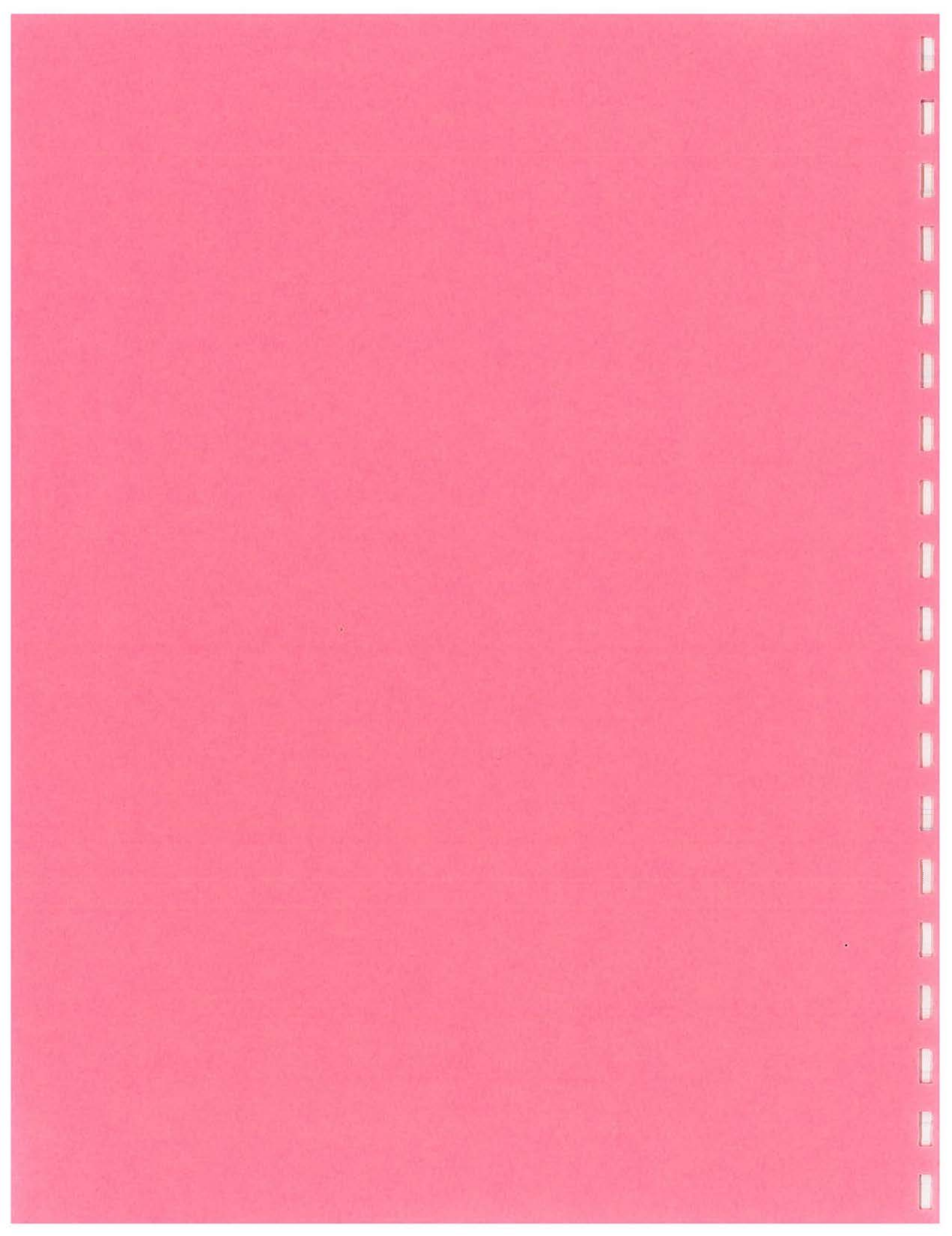

MANUFACTURER DIRECTORY

THEREF(tm) Version 4.30

PAGE 1

---

ACCEL COMPUTER Corporation  
17145 Von Karman Ave, Suite 110  
Irvine CA 92714

WATTS LINE:  
PAY LINE: 714.757.1212  
FAX LINE:  
BBS LINE:

ACCEL

---

ACCULOGIC  
13715 Alton Parkway  
Irvine CA 92718

WATTS LINE:  
PAY LINE: 714.454.2441  
FAX LINE:  
BBS LINE:

ACCULOGIC

---

ADAPTEC, Incorporated  
691 South Milpitas Blvd.  
Milpitas CA 95035

WATTS LINE: 800.869.8883  
PAY LINE: 408.945.8600  
FAX LINE: 408.262.2533  
BBS LINE: 408.945.7727

ADAPTEC                      TECH SUPPORT:2550

---

ADVANCED DIGITAL INFORMATION Corp.  
14737 NE 87th St, PO Box 2996  
Redmond WA 98073

WATTS LINE: 800.336.1233  
PAY LINE:  
FAX LINE:  
BBS LINE: 714.894.0893

A.D.I.C.

---

ADVANCED INFORMATION CONCEPTS  
2150 Paragon Drive  
San Jose CA 95131

WATTS LINE:  
PAY LINE: 408.433.9776  
FAX LINE:  
BBS LINE:

ADVANCED INFO.

---

ADVANCED STORAGE CONCEPTS, Inc.  
10855 Rockley Road  
Houston TX 77099

WATTS LINE:  
PAY LINE: 713.879.4090  
FAX LINE:  
BBS LINE:

ADVANCED STOR.

---

ADVANCED TECHNOLOGY DEVELOPMENT, Inc  
550 E. Brokaw Rd, PO Box 49048  
San Jose CA 95161-9048

WATTS LINE:  
PAY LINE: 408.954.8525  
FAX LINE: 408.954.0725  
BBS LINE:

ATD

---

ALPHA RESEARCH Corporation  
10435 Burnet Rd, Suite 109  
Austin TX 78758

WATTS LINE:  
PAY LINE: 512.836.0709  
FAX LINE: 512.836.0944  
BBS LINE:

ALPHA RESEARCH

---

MANUFACTURER DIRECTORY

THEREF(tm) Version 4.30

PAGE 2

---

ALPHATRONIX, Incorporated  
2300 Englert Dr, PO Box 13687  
Rsch.Triangle Pk NC 27709-3687

WATTS LINE:  
PAY LINE: 919.544.0001  
FAX LINE:  
BBS LINE:

ALPHATRONIX

---

ALPS ELECTRIC (USA), Incorporated  
3553 N. First Street  
San Jose CA 95134

WATTS LINE:  
PAY LINE: 408.432.6000  
FAX LINE:  
BBS LINE:

ALPS ELEC.

---

ALWAYS TECHNOLOGY Corp.  
31336 Via Colinas, Suite 101  
Westlake Village CA 91362

WATTS LINE:  
PAY LINE: 818.597.1400  
FAX LINE: 818.597.1496  
BBS LINE: 818.597.0275

ALWAYS TECH. TECH SUPPORT:9595

---

AMERICAN DIGITAL SYSTEMS, Inc.  
490 Boston Post Road  
Sudbury MA 01776

WATTS LINE:  
PAY LINE: 508.443.7711  
FAX LINE:  
BBS LINE:

A.D.S.I.

---

AMERICAN MEGATRENDS, Incorporated  
1346 Oakbrook Drive  
Norcross GA 30093

WATTS LINE: 800.828.9264  
PAY LINE: 404.263.8181  
FAX LINE: 404.263.9381  
BBS LINE: 404.246.8780

A.M.I. ADDL BBS:8782, 8783(V.32), 8781(HST)

---

AMERICAN MULTISOURCE, Incorporated  
42000 Christy Street  
Fremont CA 94538

WATTS LINE:  
PAY LINE: 415.657.2288  
FAX LINE:  
BBS LINE:

AMS ? :415.657.0901

---

AMERICAN TELEPHONE & TELEGRAPH, Inc

WATTS LINE: 800.247.1212  
PAY LINE:  
FAX LINE:  
BBS LINE: 201.769.6397

AT&T

---

AMPEX Corporation

WATTS LINE:  
PAY LINE:  
FAX LINE:  
BBS LINE:

AMPEX

---



MANUFACTURER DIRECTORY

THEREF(tm) Version 4.30

PAGE 3

---

APPLE COMPUTER, Inc.  
20330 Stevens Creek Blvd.  
Cupertino CA 95014

WATTS LINE:  
PAY LINE: 408.922.0333  
FAX LINE:  
BBS LINE:

APPLE

---

ARCO ELECTRONICS, Inc.  
5830 Sheridan Street  
Hollywood FL 33021

WATTS LINE:  
PAY LINE: 305.961.1666  
FAX LINE:  
BBS LINE:

ARCO ELECTRONICS

---

AREAL TECHNOLOGY, Inc.  
2075 Zanker Road  
San Jose CA 95131

WATTS LINE:  
PAY LINE: 408.436.6800  
FAX LINE: 408.436.6844  
BBS LINE:

AREAL TECH.

---

ARIX COMPUTER Corporation  
821 Fax Lane  
San Jose CA 95131

WATTS LINE:  
PAY LINE: 408.432.1200  
FAX LINE:  
BBS LINE:

ARIX COMP.

---

ATASI TECHNOLOGY, Inc.  
1140 Ringwood Court  
San Jose CA 95131

WATTS LINE:  
PAY LINE: 408.954.8680  
FAX LINE:  
BBS LINE:

ATASI (also, TANDON/WD PURCH. OF SOME DRIVES)

---

ATTO TECHNOLOGY, Inc.  
Baird Rh.Pk, 1576 Sweet Home Rd  
Amherst NY 14228

WATTS LINE:  
PAY LINE: 716.688.4259  
FAX LINE: 716.636.3630  
BBS LINE:

ATTO TECHNOLOGY

---

AURA ASSOCIATES  
2605 S. Winchester Blvd.  
Campbell CA 95008

WATTS LINE:  
PAY LINE: 408.252.2872  
FAX LINE: 408.252.2876  
BBS LINE:

AURA ASSOCIATES SALES: 408.366.7450, 408.252.9842 (fax)

---

AURORA TECHNOLOGIES, Inc.  
Cambridge MA

WATTS LINE:  
PAY LINE: 617.577.1288  
FAX LINE:  
BBS LINE:

AURORA TECH.

---

MANUFACTURER DIRECTORY

THEREF(tm) Version 4.30

PAGE 4

AXES TECHNOLOGIES, Inc.

Carrollton TX

AXES TECHNOLOGY

WATTS LINE:

PAY LINE: 214.446.2937

FAX LINE:

BBS LINE:

B.A.S.F. Corp., Info Systems Div.

Crosby Drive

Bedford MA 01730

BASF

WATTS LINE:

PAY LINE: 617.271.4000

FAX LINE:

BBS LINE:

BOCA DESIGN, Incorporated

FL

BOCA DESIGN

SCSI HOST ADAPTERS

WATTS LINE:

PAY LINE: 407.451.4462

FAX LINE: 407.451.4463

BBS LINE:

BUSLOGIC, Incorporated

4151 Burton Drive

Santa Clara CA 95054

BUSLOGIC

Suite 109-121,

WATTS LINE:

PAY LINE: 408.492.9090

FAX LINE: 408.492.1542

BBS LINE:

BUSTEK Corporation

BUSTEK

WATTS LINE:

PAY LINE:

FAX LINE:

BBS LINE:

RENAMED TO BUSLOGIC, Incorporated

C & C TECHNOLOGY, Incorporated

245 W.Roosevelt Rd,Bld9,Unit60

West Chicago IL 60185

C & C TECHNOLOGY

WATTS LINE:

PAY LINE: 708.231.0015

FAX LINE:

BBS LINE:

C.I.E. AMERICA, Inc. (C.ITOH)

2515 McCabe Way

Irvine CA 92714

C.ITOH & Co.

WATTS LINE: 800.347.2484

PAY LINE: 714.660.1421

FAX LINE:

BBS LINE:

CANON

CANON

WATTS LINE:

PAY LINE:

FAX LINE:

BBS LINE:

MANUFACTURER DIRECTORY

THEREF(tm) Version 4.30

PAGE 5

CARDIFF PERIPHERALS Corporation  
 5441 Avenida Encinas, Suite B  
 Carlsbad CA 92008

WATTS LINE:  
 PAY LINE: 619.931.8032  
 FAX LINE: 619.931.0973  
 BBS LINE:

CARDIFF

CD ROM, Incorporated

WATTS LINE: 800.821.5245  
 PAY LINE: 303.231.9373  
 FAX LINE:  
 BBS LINE:

Golden CO

CD ROM

CD TECHNOLOGY, Inc.

WATTS LINE:  
 PAY LINE: 408.752.8500  
 FAX LINE:  
 BBS LINE:

Sunnyvale CA

CD TECH.

CENTURY DATA, Incorporated  
 1270 N. Cramer Blvd.  
 Anaheim CA 92806

WATTS LINE:  
 PAY LINE: 714.632.7500  
 FAX LINE:  
 BBS LINE:

CENTURY DATA

CHICONY

WATTS LINE:  
 PAY LINE: 714.771.9067  
 FAX LINE:  
 BBS LINE:

CA

CHICONY

CHINON AMERICA, Inc.  
 615 Hawaii Avenue  
 Torrance CA 90503

WATTS LINE: 800.441.0222  
 PAY LINE: 310.533.0274  
 FAX LINE: 310.533.1727  
 BBS LINE:

CHINON (1993),

CIPRICO, Incorporated  
 2955 Xenium Lane  
 Plymouth MN 55441

WATTS LINE: 800.727.4669  
 PAY LINE: 612.559.2034  
 FAX LINE: 612.559.8799  
 BBS LINE:

CIPRICO

CMS ENHANCEMENTS, Inc.  
 2722 Michelson Drive  
 Irvine CA 92715

WATTS LINE:  
 PAY LINE: 714.222.6000  
 FAX LINE: 714.549.4004  
 BBS LINE:

CMS ENHANCE.

MANUFACTURER DIRECTORY

THEREF(tm) Version 4.30

PAGE 6

COGENT DATA TECHNOLOGIES, Inc.  
 175 West St., P.O.Box 926  
 Friday Harbor WA 98250

WATTS LINE:  
 PAY LINE: 206.378.2929  
 FAX LINE:  
 BBS LINE:

COGENT DATA

COGITO

WATTS LINE:  
 PAY LINE:  
 FAX LINE:  
 BBS LINE:

COGITO

COLUMBIA DATA PRODUCTS, Inc.  
 P.O.Box 2584  
 Altamonte Spr. FL 32714-2584

WATTS LINE:  
 PAY LINE: 407.869.6700  
 FAX LINE: 407.862.4725  
 BBS LINE: 407.862.4724

C.D.P. SCSI SOFTWARE

COMMAX TECHNOLOGY

WATTS LINE:  
 PAY LINE:  
 FAX LINE:  
 BBS LINE:

COMMAX TECH.

COMPUADD Corporation  
 12303 Technology Blvd.  
 Austin TX 78727

WATTS LINE: 800.456.3116  
 PAY LINE: 512.250.1489  
 FAX LINE: 512.250.2070  
 BBS LINE:

COMPUADD

COMPUTER MEMORIES, Incorporated

WATTS LINE: OUT  
 PAY LINE: OF  
 FAX LINE: BUSINESS  
 BBS LINE:

CMI original IBM AT supplier

CONCURRENT COMPUTER Corporation  
 106 Apple Street  
 Tinton Falls NJ 07724

WATTS LINE: 800.631.2154  
 PAY LINE:  
 FAX LINE:  
 BBS LINE:

CONCURRENT

CONNER PERIPHERALS, Incorporated  
 3081 Zanker Road  
 San Jose CA 95134

WATTS LINE:  
 PAY LINE: 408.456.4500  
 FAX LINE: 408.456.4501  
 BBS LINE: 408.456.4515

CONNER TECH SUPT:3388, MANUALS:4415, HOT LINE:3200

MANUFACTURER DIRECTORY

THEREF(tm) Version 4.30

PAGE 7

CONSAN, Incorporated  
14625 Martin Drive  
Eden Prairie MN 55344

WATTS LINE:  
PAY LINE: 612.949.0053  
FAX LINE:  
BBS LINE:

CONSAN, INC.

CONTROL CONCEPTS, Incorporated  
VA

WATTS LINE:  
PAY LINE: 703.876.6444  
FAX LINE: 703.876.6416  
BBS LINE:

CONTROL CONCEPTS

CONTROL DATA Corporation  
12501 Whitewater Drive  
Minnetonka MN 55343

WATTS LINE: BOUGHT  
PAY LINE: BY  
FAX LINE: SEAGATE  
BBS LINE:

CDC MAG. PERIPHERALS, IMPRIMIS

CORE International, Inc.  
7171 North Federal Highway  
Boca Raton FL 33487

WATTS LINE:  
PAY LINE: 407.997.6044  
FAX LINE: 407.997.6009  
BBS LINE: 407.241.2929

CORE INTL.

COREL SYSTEMS Corporation  
1600 Carling Avenue  
Ottawa, Ontario CN K1Z 8R7

WATTS LINE: 800.836.SCSI  
PAY LINE: 613.728.8200  
FAX LINE: 613.728.9790  
BBS LINE: 613.728.4752

COREL SYSTEMS

CORPORATE SYSTEMS CENTER  
730 North Pastoria Avenue  
Sunnyvale CA 94086

WATTS LINE:  
PAY LINE: 408.737.7312  
FAX LINE: 408.737.1017  
BBS LINE:

C.S.C.

DATA TECHNOLOGY Corp. (QUME)  
15 Centerpoint Drive  
Milpitas CA 95035

WATTS LINE:  
PAY LINE: 408.942.4000  
FAX LINE: 408.942.4052  
BBS LINE: 408.942.4010

DATA TECHNOLOGY TECH:4091,4044, 24HR FAXBACK:4005

DAUPHIN TECHNOLOGY, Inc.  
1125 East St.Charles Road  
Lombard IL 60148

WATTS LINE:  
PAY LINE: 708.627.4004  
FAX LINE:  
BBS LINE:

DAUPHIN TECH.

MANUFACTURER DIRECTORY

THEREF(tm) Version 4.30

PAGE 8

---

DELTAC SYSTEMS  
1977 O'Toole Ave, Suite B206  
San Jose CA 95131

WATTS LINE:  
PAY LINE: 408.954.1055  
FAX LINE:  
BBS LINE:

DELTAC SYSTEMS

---

DENON AMERICA, Inc.  
222 New Road  
Parsippany NJ 07054

WATTS LINE:  
PAY LINE: 201.575.7810  
FAX LINE:  
BBS LINE:

DENON

---

DIGITAL EQUIPMENT Corp. (DEC)  
334 South Street  
Shrewsbury MA 01545

WATTS LINE:  
PAY LINE: 508.897.5111  
FAX LINE:  
BBS LINE:

D.E.C.

---

DISCTRON

WATTS LINE:  
PAY LINE:  
FAX LINE:  
BBS LINE:

DISCTRON

---

DISK TECHNOLOGIES Corp.  
PO Box 1750, 147 W.Lyman Ave.  
Winter Park FL 32790

WATTS LINE: 800.553.0337  
PAY LINE: 407.645.0001  
FAX LINE:  
BBS LINE:

DISK TECH.

---

DISTRIBUTED PROCESSING TECHNOLOGY  
140 Candace Drive  
Maitland FL 32751

WATTS LINE:  
PAY LINE: 407.830.5522  
FAX LINE: 407.260.5366  
BBS LINE: 407.831.6432

D.P.T.

---

DMA

WATTS LINE:  
PAY LINE:  
FAX LINE:  
BBS LINE:

DMA

---

DOLPHIN SYSTEMS TECHNOLOGY  
1701 E. Edinger Ave, Bldg. G  
Santa Ana CA 92705

WATTS LINE:  
PAY LINE: 714.558.3220  
FAX LINE:  
BBS LINE:

DOLPHIN SYSTEMS

---

MANUFACTURER DIRECTORY

THEREF(tm) Version 4.30

PAGE 9

DYNATEK AUTOMATION SYSTEMS, Inc.  
 15 Tangiers Road  
 Toronto, Ontario CN M3J 2B1

WATTS LINE:  
 PAY LINE: 416.636.3000  
 FAX LINE: 416.636.3011  
 BBS LINE:

DYNATEK SYSTEMS

ELCOH

WATTS LINE:  
 PAY LINE:  
 FAX LINE:  
 BBS LINE:

ELCOH

EMULEX Corporation  
 3545 Harbor Blvd., P.O.Box 6725  
 Costa Mesa CA 92626

WATTS LINE: 800.368.5393  
 PAY LINE: 714.662.5600  
 FAX LINE: 714.241.0792  
 BBS LINE:

EMULEX MASS FIELD OFFICE: 617.229.8880

EPSON AMERICA, Inc.  
 20770 Madrona Ave, Box 2842  
 Torrance CA 90509-2842

WATTS LINE:  
 PAY LINE: 310.787.6300  
 FAX LINE: 310.782.5350  
 BBS LINE:

EPSON

EsPerT Company, LTD.  
 1630 Oakland Road, A-109  
 San Jose CA 95131

WATTS LINE:  
 PAY LINE: 408.452.5771  
 FAX LINE:  
 BBS LINE:

ESPERT 508.668.4030, 408.452.5771

EVEREX SYSTEMS, Incorporated  
 48431 Millmont Drive  
 Fremont CA 94538-9828

WATTS LINE: 800.334.4552  
 PAY LINE: 415.498.1111  
 FAX LINE:  
 BBS LINE:

EVEREX

EXSYS STORAGE SYSTEMS, Inc.  
 1430 Tully Road, Suite 417  
 San Jose CA 95112

WATTS LINE:  
 PAY LINE: 408.292.0343  
 FAX LINE:  
 BBS LINE:

EXSYS SYSTEMS

FARADAY ELECTRONICS  
 749 North Mary Avenue  
 Sunnyvale CA 94086

WATTS LINE: 800.847.6181  
 PAY LINE: 408.749.1900  
 FAX LINE: 408.739.1671  
 BBS LINE:

FARADAY bought by WESTERN DIGITAL

MANUFACTURER DIRECTORY

THEREF (tm) Version 4.30

PAGE 10

FAST TECHNOLOGY, Incorporated  
 3204 South Fair Lane  
 Tempe AZ 85282

WATTS LINE: 800.279.0889  
 PAY LINE: 602.438.0889  
 FAX LINE: 602.438.9222  
 BBS LINE:

FAST TECHNOLOGY see also KONAN, PERSTOR, LAURA TECH.

FUJI Corporation

WATTS LINE:  
 PAY LINE:  
 FAX LINE:  
 BBS LINE:

FUJI

FUJITSU AMERICA, Incorporated  
 3055 Orchard Drive  
 San Jose CA 95134-2022

WATTS LINE: 800.626.4686  
 PAY LINE: 408.432.1300  
 FAX LINE: 408.432.1318  
 BBS LINE: 408.944.9899

FUJITSU 24 HOUR TECH SUPPORT:800.826.6112

FUTURE DOMAIN Corporation  
 2801 McGaw Avenue  
 Irvine CA 92714

WATTS LINE: 800.879.7599  
 PAY LINE: 714.253.0400  
 FAX LINE: 714.253.0913  
 BBS LINE:

FUTURE DOMAIN

FWB, Incorporated  
 2040 Polk Street, Suite 215  
 San Francisco CA 94109

WATTS LINE:  
 PAY LINE: 415.474.8055  
 FAX LINE:  
 BBS LINE:

FWB

GENERAL MICROSYSTEMS, Inc.  
 3220 118th Ave.SE, Suite 100  
 Bellevue WA 98005

WATTS LINE:  
 PAY LINE: 206.644.2233  
 FAX LINE:  
 BBS LINE:

GEN.MICROSYS

GSI  
 17951 H Sky Park Circle  
 Irvine CA 92714-6343

WATTS LINE: 800.486.7800  
 PAY LINE: 714.261.7949  
 FAX LINE: 714.757.1778  
 BBS LINE:

GSI

HERSTAL AUTOMTION, Ltd.  
 3171 W.Twelve Mile Road  
 Berkley MI 48072

WATTS LINE:  
 PAY LINE: 313.548.2001  
 FAX LINE:  
 BBS LINE:

HERSTAL



MANUFACTURER DIRECTORY

THEREF(tm) Version 4.30

PAGE 11

HEWLETT-PACKARD, Disk Memory Div. 11413 Chinden Blvd., MS 337 Boise ID 83714	WATTS LINE: 800.752.0900 PAY LINE: 208.323.2332 FAX LINE: 208.323.3991 BBS LINE:
HEWLETT-PKD.	208.323.2297, DIRECT MKT'G:800.637.7740

HITACHI AMERICA, COMPUTER DIV. 2000 Sierra Point Parkway Brisbane CA 94005-1819	WATTS LINE: 800.283.4080 PAY LINE: 415.589.8300 FAX LINE: 415.244.7647 BBS LINE:
HITACHI	415.589.8300

HONEYWELL/BULL Corporation	WATTS LINE: PAY LINE: FAX LINE: BBS LINE:
BULL	

IBM Corp., ADSTAR OEM PRODUCTS DIV. 5600 Cottle Road San Jose CA 95193	WATTS LINE: PAY LINE: 408.284.6039 FAX LINE: BBS LINE:
IBM	

IMPERIAL TECHNOLOGY, Incorporated 2305 Utah Avenue El Segundo CA 90245	WATTS LINE: 800.451.0666 PAY LINE: 310.536.0018 FAX LINE: 310.536.0124 BBS LINE:
IMPERIAL TECH.	

INSITE PERIPHERALS 4433 Fortran Drive San Jose CA 95134-4403	WATTS LINE: PAY LINE: 408.946.8080 FAX LINE: 408.946.4403 BBS LINE:
INSITE	

INTEGRAL PERIPHERALS, Incorporated 5775 Flatiron Pkwy, Suite 100 Boulder CO 80301	WATTS LINE: PAY LINE: 303.449.8009 FAX LINE: 303.449.8089 BBS LINE:
INTEGRAL	

INTERNATIONAL MEMORIES, Inc.	WATTS LINE: PAY LINE: FAX LINE: BBS LINE:
IMI	

MANUFACTURER DIRECTORY

THEREF (tm) Version 4.30

PAGE 12

INTERPHASE Corporation  
 13800 Senlac Drive  
 Dallas TX 75234

WATTS LINE:  
 PAY LINE: 214.919.9000  
 FAX LINE: 214.919.9200  
 BBS LINE:

INTERPHASE

JASMINE TECHNOLOGIES, Inc.  
 1740 Army Street  
 San Francisco CA 94124

WATTS LINE:  
 PAY LINE: 415.550.2900  
 FAX LINE:  
 BBS LINE:

JASMINE

JC INFORMATION SYSTEMS Corp.  
 44036 S. Grimmer Blvd.  
 Fremont CA 94538

WATTS LINE:  
 PAY LINE: 510.659.8440  
 FAX LINE: 510.659.8449  
 BBS LINE:

JC INFO SYSTEMS

JCT

WATTS LINE:  
 PAY LINE:  
 FAX LINE:  
 BBS LINE:

JCT

JETS CYBERNETICS  
 The Penthouse, 535 Ramona St.  
 Palo Alto CA 94301

WATTS LINE: 800.369.JETS  
 PAY LINE: 415.322.JETS  
 FAX LINE:  
 BBS LINE:

JETS CYBERNETICS

JVC INFORMATION PRODUCTS of America  
 Santa Clara CA

WATTS LINE:  
 PAY LINE: 408.988.7506  
 FAX LINE: 408.727.7533  
 BBS LINE:

JVC

KALOK Corporation  
 1289 Anvilwood Avenue  
 Sunnyvale CA 94089

WATTS LINE:  
 PAY LINE: 408.747.1315  
 FAX LINE: 408.747.1319  
 BBS LINE:

KALOK CORP.

KIMPSION International  
 1335 Rothland Court  
 San Jose CA 95131

WATTS LINE:  
 PAY LINE:  
 FAX LINE:  
 BBS LINE:

KIMPSION

MANUFACTURER DIRECTORY

THEREF(tm) Version 4.30

PAGE 13

---

KONAN Corporation  
1829 West Drake Drive  
Tempe AZ 85283

WATTS LINE:  
PAY LINE: 602.345.1300  
FAX LINE: 602.345.2829  
BBS LINE:

KONAN see also FAST TECH., TEN TIME, LAURA TECH.

---

KYOCERA ELEC.Inc, Memory Prod.Div.  
8611 Balboa Avenue  
San Diego CA 92123-1580

WATTS LINE:  
PAY LINE: 619.576.2702  
FAX LINE: 619.492.1456  
BBS LINE:

KYOCERA 201.563.4333, 201.563.4300

---

LAPINE TECHNOLOGY

WATTS LINE:  
PAY LINE:  
FAX LINE:  
BBS LINE:

OUT OF BUSINESS

LAPINE

---

LARK ASSOCIATES, Inc.  
4046 Clipper Court  
Fremont CA 94538

WATTS LINE: OUT  
PAY LINE: OF  
FAX LINE: BUSINESS  
BBS LINE: 1991

LARK ASSOCS.

---

LASER MAGNETIC STORAGE Intl. Co.  
4425 ArrowsWest Drive  
Colorado Springs CO 80907-

WATTS LINE:  
PAY LINE: 719.593.7900  
FAX LINE: 719.531.0168  
BBS LINE:

LASER MAG.

---

LAURA TECHNOLOGIES, Inc.  
3212 South Fair Lane  
Tempe AZ 85282

WATTS LINE:  
PAY LINE: 602.438.0889  
FAX LINE: 602.438.9222  
BBS LINE:

LAURA TECH. see also FAST TECH., TEN TIME, PERSTOR

---

LIBERTY SYSTEMS, Incorporated  
160 Saratoga Ave, Suite 38  
Santa Clara CA 95051

WATTS LINE:  
PAY LINE: 408.983.1127  
FAX LINE: 408.243.2885  
BBS LINE:

LIBERTY SYSTEMS

---

LOMAS DATA PRODUCTS Incorporated  
182 Cedar Hill Street  
Marlboro MA 01752

WATTS LINE:  
PAY LINE: 508.460.0333  
FAX LINE: 508.460.0616  
BBS LINE:

LOMAS DATA PROD.

---

MANUFACTURER DIRECTORY

THEREF (tm) Version 4.30

PAGE 14

---

LONGSHINE ELECTRONICS  
2013 North Capitol Avenue  
San Jose CA 95132

WATTS LINE:  
PAY LINE: 408.942.1746  
FAX LINE: 408.942.1745  
BBS LINE:

LONGSHINE

---

MACROTRON SYSTEMS, Incorporated  
4400 Technology Drive  
Fremont CA 94538

WATTS LINE:  
PAY LINE: 510.683.9600  
FAX LINE: 510.651.6922  
BBS LINE:

MACROTRON SYSTEM

---

MACSETRA TECHNOLOGIES INTL., Inc.  
2414 Koyl Avenue  
Saskatoon, Sktwn. CN S7L 7L5

WATTS LINE: 800.661.6000  
PAY LINE: 306.934.6044  
FAX LINE:  
BBS LINE:

MACSETRA

---

MAGNETIC PERIPHERALS, Incorporated

WATTS LINE:  
PAY LINE:  
FAX LINE:  
BBS LINE:

MPI CDC'S HARD DRIVE DIV., now owned by SEAGATE

---

MAGTRON, Incorporated  
568 Weddell Drive  
Sunnyvale CA 94089

WATTS LINE: 800.828.2822  
PAY LINE: 408.774.1188  
FAX LINE:  
BBS LINE:

MAGTRON aka PACIFIC MAGTRON

---

MANZANTA MICROSYSTEMS, Inc.  
P.O. Box 2117  
Goleta CA 93118

WATTS LINE:  
PAY LINE: 805.968.1387  
FAX LINE: 805.968.5449  
BBS LINE:

MANZANTA MICROSY

---

MAPLE SYSTEMS, Incorporated  
2380 Qume Drive, Suite B  
San Jose CA 95131

WATTS LINE:  
PAY LINE: 408.456.0355  
FAX LINE: 408.456.0356  
BBS LINE:

MAPLE SYSTEMS

---

MASS OPTICAL STORAGE TECHNOLOGIES,  
11205 Knott Avenue  
Cypress CA 90630

WATTS LINE:  
PAY LINE: 714.898.9400  
FAX LINE: 714.373.9960  
BBS LINE:

M.O.S.T. MOST, INC.

---

MANUFACTURER DIRECTORY

THEREF(tm) Version 4.30

PAGE 15

MAXCESS, Incorporated  
3141 North 13th Street  
Philadelphia PA 19107

WATTS LINE:  
PAY LINE: 215.928.1213  
FAX LINE:  
BBS LINE:

MAXCESS

MAXOPTIX Corporation (MAXTOR  
2520 Junction Avenue  
San Jose CA 95134

WATTS LINE: 800.848.3092  
PAY LINE: 408.954.9700  
FAX LINE: 408.954.9711  
BBS LINE:

MAXOPTIX

MAXTOR COLORADO Corp.  
1861 Lefthand Circle  
Longmont CO 80501-6798

WATTS LINE: 800.356.5333  
PAY LINE: 303.651.6000  
FAX LINE: 303.678.2165  
BBS LINE: 303.678.2222

MAXTOR COLORADO BBS9600:2020, FAXBACK LINE:303.678.2615

MAXTOR Corporation  
211 River Oaks Parkway  
San Jose CA 95134

WATTS LINE: 800.2.MAXTOR  
PAY LINE: 408.432.1700  
FAX LINE: 408.433.0457  
BBS LINE: 303.678.2222

MAXTOR BBS9600:2020, 408.432.4517, 408.435.7884

MEGADRIVE SYSTEMS, Inc.  
1900 Ave of the Stars, Ste.2870  
Los Angeles CA 90067

WATTS LINE: 800.327.4744  
PAY LINE: 213.556.1663  
FAX LINE: 213.556.1164  
BBS LINE:

MEGADRIVE

MEMOREX Corporation  
611 South Milpitas Blvd.  
Milpitas CA 95035-5473

WATTS LINE:  
PAY LINE: 408.957.1000  
FAX LINE:  
BBS LINE:

MEMOREX

MEMTECH TECHNOLOGY Corporation  
3000 Oakmead Village Court  
Santa Clara CA 95051

WATTS LINE: 800.445.5511  
PAY LINE: 408.970.8900  
FAX LINE: 408.986.0656  
BBS LINE:

MEMTECH

MERIDIAN DATA, Incorporated  
5615 Scotts Valley Drive  
Scotts Valley CA 95066

WATTS LINE: 800.755.8324  
PAY LINE: 408.438.3100  
FAX LINE:  
BBS LINE:

MERIDIAN

MANUFACTURER DIRECTORY

THEREF(tm) Version 4.30

PAGE 16

MICRO DESIGN International, Inc.  
 6985 University Blvd.  
 Winter Park FL 32792

WATTS LINE:  
 PAY LINE: 407.677.8333  
 FAX LINE:  
 BBS LINE:

MICRO DESIGN

MICRO MEMORY, Incorporated (MMI)  
 9540 Vassar Avenue  
 Chatsworth CA 91311

WATTS LINE:  
 PAY LINE: 818.998.0070  
 FAX LINE:  
 BBS LINE:

MMI

MICRO SOLUTIONS COMPUTER PRODUCTS  
 132 West Lincoln Highway  
 DeKalb IL 60115

WATTS LINE:  
 PAY LINE: 815.756.3411  
 FAX LINE: 815.756.2928  
 BBS LINE:

MICRO SOLUTIONS

MICRONET COMPUTER SYSTEMS, Inc.  
 Buena Park CA

WATTS LINE:  
 PAY LINE: 714.739.2244  
 FAX LINE:  
 BBS LINE:

MICRONET

MICRONET TECHNOLOGY, Incorporated  
 20 Mason  
 Irvine CA 92718

WATTS LINE:  
 PAY LINE: 714.837.6033  
 FAX LINE: 714.837.1164  
 BBS LINE:

MICRONET TECH.

MICROPOLIS Corporation  
 21123 Nordhoff Street  
 Chatsworth CA 91311

WATTS LINE:  
 PAY LINE: 818.709.3300  
 FAX LINE: 818.709.3396  
 BBS LINE: 818.709.3310

MICROPOLIS TECH#:3325

MICROSCIENCE INTL. Corporation  
 90 Headquarters Drive  
 San Jose CA 95134

WATTS LINE:  
 PAY LINE: 408.433.9898  
 FAX LINE: 408.954.0989  
 BBS LINE:

MICROSCIENCE

MINISCRIBE Corporation  
 1861 Lefthand Circle  
 Longmont CO 80501-6798

WATTS LINE:  
 PAY LINE:  
 FAX LINE:  
 BBS LINE:

MINISCRIBE now MAXTOR COLORADO Corp.

MANUFACTURER DIRECTORY

THEREF(tm) Version 4.30

PAGE 17

MINISTOR PERIPHERALS  
2801 Orchard Parkway  
San Jose CA 95134

WATTS LINE:  
PAY LINE: 408.943.0165  
FAX LINE: 408.434.0784  
BBS LINE:

MINISTOR

MIRROR TECHNOLOGIES  
2644 Patton Road  
Roseville MN 55113

WATTS LINE:  
PAY LINE: 612.633.4450  
FAX LINE:  
BBS LINE:

MIRROR TECH.

MITSUBISHI ELECTRONICS AMERICA, Inc.  
991 Knox Street  
Torrance CA 90502

WATTS LINE: 800.515.6352  
PAY LINE: 213.515.3993  
FAX LINE: 213.324.6466  
BBS LINE:

MITSUBISHI 213.217.5732

MITSUMI ELECTRONICS  
Santa Clara CA

WATTS LINE:  
PAY LINE: 408.970.0700  
FAX LINE:  
BBS LINE:

MITSUMI

MYLEX Corporation  
47650 Westinghouse Drive  
Fremont CA 94539

WATTS LINE: 800.446.9539  
PAY LINE: 415.683.4600  
FAX LINE: .415.656.7857  
BBS LINE:

MYLEX

N/HANCE SYSTEMS, Incorporated  
908R Providence Highway  
Dedham MA 02026

WATTS LINE: 800.BUY.WORM  
PAY LINE: 617.461.1970  
FAX LINE:  
BBS LINE:

N/HANCE SYS.

NCL AMERICA, Incorporated  
1221 Innsbruck Drive  
Sunnyvale CA 94086

WATTS LINE:  
PAY LINE: 408.734.1006  
FAX LINE: 408.774.0709  
BBS LINE:

NCL AMERICA

NCR Corporation  
1700 S. Patterson Blvd.  
Dayton OH 45479

WATTS LINE: 800.334.5454  
PAY LINE: 513.445.2075  
FAX LINE:  
BBS LINE:

NCR CONTROLLERS

MANUFACTURER DIRECTORY

THEREF(tm) Version 4.30

PAGE 18

---

NCR Corporation  
3718 North Rock Road  
Wichita KS 67226

WATTS LINE:  
PAY LINE: 316.636.8000  
FAX LINE:  
BBS LINE:

NCR DRIVES

---

NEC TECHNOLOGIES, Incorporated  
1414 Massachusetts Avenue  
Boxborough MA 01719-2298

WATTS LINE: 800.NEC.INFO  
PAY LINE: 508.264.8000  
FAX LINE: 508.264.8673  
BBS LINE:

NEC Faxback#:800.366.0476

---

NEWBURY DATA  
6 New England Executive Plaza  
Burlington MA 01803

WATTS LINE:  
PAY LINE: 617.723.9513  
FAX LINE:  
BBS LINE:

NEWBURY DATA licenced by Maxtor

---

NIPPON PERIPHERALS, Ltd.

WATTS LINE:  
PAY LINE:  
FAX LINE:  
BBS LINE:

NIPPON

---

NOVELL

WATTS LINE:  
PAY LINE:  
FAX LINE:  
BBS LINE:

NOVELL see PROCOMP USA

---

OCEAN MICROSYSTEMS, Incorporated  
246 East Hacienda Avenue  
Campbell CA 95008

WATTS LINE: 800.944.6232  
PAY LINE: 408.374.8300  
FAX LINE: 714.373.9979  
BBS LINE:

OCEAN MICRO

---

OKIDATA  
532 Fellowship Road  
Mount Laurel NJ 08054

WATTS LINE:  
PAY LINE: 609.235.2600  
FAX LINE:  
BBS LINE:

OKIDATA

---

OLIVETTI, USA

WATTS LINE:  
PAY LINE: 201.526.8200  
FAX LINE:  
BBS LINE:

OLIVETTI

---



MANUFACTURER DIRECTORY

THEREF(tm) Version 4.30

PAGE 19

---

ONLINE PRODUCTS Corp.  
20251 Century Blvd.  
Germantown MD 20874

WATTS LINE: 800.922.9204  
PAY LINE: 301.428.3700  
FAX LINE:  
BBS LINE:

ONLINE PROD.

---

OPTIMA TECHNOLOGY Corp.  
17526 Von Karman  
Irvine CA 92714

WATTS LINE:  
PAY LINE: 714.476.0515  
FAX LINE: 714.476.0613  
BBS LINE: 714.476.0626

OPTIMA

---

ORCA TECHNOLOGY Corp.  
1751 Fox Drive  
San Jose CA 95131

WATTS LINE:  
PAY LINE: 408.441.1111  
FAX LINE:  
BBS LINE:

ORCA TECH.

---

OTARI Corporation  
378 Vintage Park Drive  
Foster City CA 94404

WATTS LINE:  
PAY LINE: 415.341.5900  
FAX LINE:  
BBS LINE:

OTARI

---

PACIFIC RIM SYSTEMS, Inc.  
2570 Barrington Court  
Hayward CA 94545

WATTS LINE: 800.722.7461  
PAY LINE: 415.782.1013  
FAX LINE: 415.782.1017  
BBS LINE:

PACIFIC RIM (4/90)

---

PANASONIC INDUSTRIAL Company  
1600 McCandless Drive  
Milpitas CA 95035

WATTS LINE:  
PAY LINE: 408.262.2200  
FAX LINE: 408.262.4214  
BBS LINE: 201.863.7845

PANASONIC

---

PERCEPTIVE SOLUTIONS, Inc.  
2700 Flora Street  
Dallas TX 75201

WATTS LINE: 800.486.3278  
PAY LINE: 214.954.1774  
FAX LINE: 214.953.1774  
BBS LINE: 214.954.1856

PERCEPTIVE SOLS.

---

PERFORMANCE TECHNOLOGIES, Inc.  
435 West Commercial Street  
East Rochester NY 14445

WATTS LINE:  
PAY LINE: 716.586.6727  
FAX LINE:  
BBS LINE:

PERFORM. TECHS.

---

MANUFACTURER DIRECTORY

THEREF (tm) Version 4.30

PAGE 20

PERIPHERAL LAND, Inc.  
47421 Bayside Parkway  
Fremont CA 94538

WATTS LINE: 800.288.8754  
PAY LINE: 415.657.2211  
FAX LINE:  
BBS LINE:

PERIPHERAL

PERIPHERAL TECHNOLOGY, Inc.  
685 East Cochran  
Simi Valley CA 93065

WATTS LINE:  
PAY LINE: 805.581.1000  
FAX LINE:  
BBS LINE:

PTI

PERSTOR SYSTEMS, Incorporated  
1335 South Park Lane  
Tempe AZ 85281

WATTS LINE: OUT  
PAY LINE: OF  
FAX LINE: BUSINESS  
BBS LINE: 1991

PERSTOR SYSTEMS see also FAST TECH., TEN TIME, LAURA TECH.

PINNACLE MICRO  
15265 Alton Parkway  
Irvine CA 92718

WATTS LINE: 800.553.7070  
PAY LINE: 714.727.3300  
FAX LINE: 714.727.1913  
BBS LINE:

PINNACLE

PIONEER COMMUNICATIONS of America  
3255-1 Scott Blvd., Suite 103  
Santa Clara CA 95054

WATTS LINE: 800.LASER.ON  
PAY LINE: 408.988.1702  
FAX LINE: 408.988.1848  
BBS LINE:

PIONEER

PLUS DEVELOPMENT Corp.  
1778 McCarthy Blvd.  
Milpitas CA 95035

WATTS LINE: 800.624.5545  
PAY LINE: 408.434.6900  
FAX LINE:  
BBS LINE: 408.434.1664

PLUS DEV. BOUGHT BY QUANTUM, TECH: 900.740.4433, \$5/CALL

PRAIRIETEK Corporation  
1830 Lefthand Circle  
Longmont CO 80501

WATTS LINE: 800.825.2511  
PAY LINE: 303.772.4011  
FAX LINE: 303.651.3235  
BBS LINE:

PRAIRIETEK OUT OF BUSINESS 9/91

PRIAM SYSTEMS Corp.  
1140 Ringwood Court  
San Jose CA 95131

WATTS LINE:  
PAY LINE: 408.945.8680  
FAX LINE:  
BBS LINE:

PRIAM

MANUFACTURER DIRECTORY

THEREF(tm) Version 4.30

PAGE 21

PROCOM TECHNOLOGY, Inc.	WATTS LINE: 800.800.8600
2181 Dupont Avenue	PAY LINE: 714.549.0449
Irvine CA 92715	FAX LINE: 714.549.8971
	BBS LINE:
PROCOM TECH.	714.852.1000

PROCOMP USA, Incorporated	WATTS LINE:
6801 Engle Road	PAY LINE: 216.234.6387
Cleveland OH 44130	FAX LINE: 216.234.2233
	BBS LINE:
PROCOMP USA	NOVELL CONTROLLER CARDS

PROMISE TECHNOLOGY, Inc.	WATTS LINE:
1460 Koll Circle	PAY LINE: 408.452.0948
San Jose CA 95112	FAX LINE: 408.452.1534
	BBS LINE:
PROMISE TECH.	

QUANTUM Corporation	WATTS LINE: 800.624.5525
500 McCarthy Blvd.	PAY LINE: 408.944.0410
Milpitas CA 95035	FAX LINE:
	BBS LINE: 408.894.3214
QUANTUM	TECH#:900.740.4433...\$5 FLAT FEE/CALL

QUME	WATTS LINE:
	PAY LINE:
	FAX LINE:
	BBS LINE:

QUME

RANCHO TECHNOLOGY, Incorporated	WATTS LINE:
8632 Archibald Ave, Suite 109	PAY LINE: 714.987.3966
Rancho Cucamonga CA 91730	FAX LINE: 714.989.2365
	BBS LINE:
RANCHO TECHNOLOG	

REFERENCE TECHNOLOGY, Inc.	WATTS LINE:
5700 Flatiron Parkway	PAY LINE: 303.449.4157
Boulder CO 80301	FAX LINE:
	BBS LINE:
REFERENCE	

RELAX TECHNOLOGY, Incorporated	WATTS LINE:
3101 Whipple Rd, Suite 22	PAY LINE: 415.471.6112
Union City CA 94587	FAX LINE:
	BBS LINE:
RELAX TECH.	

MANUFACTURER DIRECTORY

THEREF(tm) Version 4.30

PAGE 22

---

RICOH Corp., File Products Div.  
5150 El Camino Real, Suite D20  
Los Gatos CA 94022

WATTS LINE:  
PAY LINE: 415.962.0443  
FAX LINE: 415.962.0441  
BBS LINE:

RICOH

---

RMT SYSTEMS, Incorporated  
18226 McDermott West, Suite E  
Irvine CA

WATTS LINE:  
PAY LINE: 714.863.1092  
FAX LINE:  
BBS LINE:

RMT SYSTEMS

---

RODIME SYSTEMS, Inc.  
901 Broken Sound Pkwy., N.W.  
Boca Raton FL 33487

WATTS LINE: 800.765.9292  
PAY LINE:  
FAX LINE:  
BBS LINE:

RODIME SYSTEMS

---

RODIME, Incorporated  
901 Broken Sound Pkwy., N.W.  
Boca Raton FL 33487

WATTS LINE: OUT  
PAY LINE: OF  
FAX LINE: BUSINESS  
BBS LINE: AUGUST 1991

RODIME FOR PARTS TRY: C.P.R.:407.547.5599

---

ROTATING MEMORY SERVICES (RMS)  
4919 Windplay Drive  
El Dorado Hills CA 95630

WATTS LINE:  
PAY LINE: 916.939.7500  
FAX LINE: 916.939.7504  
BBS LINE:

RMS

---

S.O.T.A. Technology, Inc.  
657 North Pastoria Avenue  
Sunnyvale CA 94086

WATTS LINE:  
PAY LINE: 408.245.3366  
FAX LINE: 408.245.0922  
BBS LINE:

SOTA

---

SANYO

WATTS LINE:  
PAY LINE:  
FAX LINE:  
BBS LINE:

SANYO

---

SEAGATE TECHNOLOGY  
930 Disc Drive  
Scotts Valley CA 95066-4544

WATTS LINE: 800.468.3472  
PAY LINE: 408.438.8222  
FAX LINE: 408.438.8137  
BBS LINE: 408.438.8771

SEAGATE TECH. BBS:8141(HST),8140(V.32),AUTOMATED FAX:2620

---

MANUFACTURER DIRECTORY

THEREF(tm) Version 4.30

PAGE 23

SEAGATE TECHNOLOGY (IMPRIMIS, CDC)	WATTS LINE: 800.828.8001
12501 Whitewater Drive	PAY LINE: 612.936.6271
Minnetonka MN 55343	FAX LINE: 612.936.6232
	BBS LINE:
SEAGATE TECH. IMPRIMIS, MPI	

SEIKO	WATTS LINE:
	PAY LINE:
	FAX LINE:
	BBS LINE:
SEIKO	

SEQUEL, Incorporated	WATTS LINE: 800.848.5837
2300 Central Expressway	PAY LINE: 408.987.1000
Santa Clara CA 95054-4972	FAX LINE:
	BBS LINE:
SEQUEL	

SHARP ELECTRONICS Corporation	WATTS LINE: 800.237.4277
Sharp Plaza	PAY LINE: 201.529.8200
Mahwah NJ 07430	FAX LINE:
	BBS LINE:
SHARP	

SHUGART ASSOCIATES, Inc.	WATTS LINE:
	PAY LINE: 714.770.1100
CA	FAX LINE:
	BBS LINE:
SHUGART see also PANASONIC	

SIEMENS INFORMATION SYSTEMS, Inc.	WATTS LINE:
1077 Business Center Circle	PAY LINE: 805.375.2500
Newbury Park CA 91320	FAX LINE: 805.499.2051
	BBS LINE:
SIEMENS bought by MICROSCIENCE, May 1990	

SILICON VALLEY COMPUTER	WATTS LINE:
140 Archer Street	PAY LINE: 415.967.1100
San Jose CA 95112	FAX LINE: 415.967.0770
	BBS LINE: 415.967.8081
SILICON VALLEY	

SMS TECHNOLOGIES, Inc.	WATTS LINE:
550 East Brokaw Rd, Box 49048	PAY LINE: 408.954.1633
San Jose CA 95161-9048	FAX LINE: 408.954.0622
	BBS LINE:
SMS TECHNOLOGIES was SCIENTIFIC MICRO SYS.	

MANUFACTURER DIRECTORY

THEREF(tm) Version 4.30

PAGE 24

SONY COMPUTER PERIPHERAL PROD. Co.  
655 River Oaks Parkway  
San Jose CA 95134

WATTS LINE: 800.352.7669  
PAY LINE: 408.432.0190  
FAX LINE: 408.432.0253  
BBS LINE:

SONY

SPECIALTY DEVELOPMENT Corp.  
P.O.Box 164017  
Austin TX 78716-4017

WATTS LINE: OUT  
PAY LINE: OF  
FAX LINE: BUSINESS  
BBS LINE: 1991

SPECIALTY DEV. (TRY ALPHA RESEARCH)

STB SYSTEMS, Incorporated  
1651 N.Glenview Dr., Suite 210  
Richardson TX 75085

WATTS LINE:  
PAY LINE: 214.234.8750  
FAX LINE:  
BBS LINE:

STB SYSTEMS

STORAGE DIMENSIONS (MAXTOR)  
2145 Hamilton Avenue  
San Jose CA 95125

WATTS LINE:  
PAY LINE: 408.879.0300  
FAX LINE: 408.879.9330  
BBS LINE:

STOR. DIMEN.

STORAGE PLUS, Inc, dba SUMO SYSTEMS  
1580 Old Oakland Rd, Suite C103  
San Jose CA 95131

WATTS LINE:  
PAY LINE: 408.453.5744  
FAX LINE: 408.453.5821  
BBS LINE:

STORAGE PLUS (SUMO SYSTEMS)

STORAGE RESEARCH, Incorporated  
1040 East Chapman Ave.  
Orange CA 92666

WATTS LINE:  
PAY LINE: 714.771.5128  
FAX LINE:  
BBS LINE:

STORAGE RESEARCH was TEGA TECHNOLOGIES

STORAGE SOLUTIONS, Incorporated  
417 Shippan Ave.  
Stamford CT 06902

WATTS LINE:  
PAY LINE: 203.325.0035  
FAX LINE:  
BBS LINE:

STOR. SOLUTIONS

SUMMUS COMPUTER SYSTEMS  
P.O.Box 219270  
Houston TX 77218

WATTS LINE:  
PAY LINE: 713.492.6611  
FAX LINE:  
BBS LINE:

SUMMUS

MANUFACTURER DIRECTORY

THEREF(tm) Version 4.30

PAGE 25

SUMO SYSTEMS	WATTS LINE: 800.451.SUMO
27281 Las Ramblas, S-170	PAY LINE: 714.348.0768
Mission Viejo CA 92691	FAX LINE: 714.348.1329
	BBS LINE:
SUMO SYSTEMS            see also STORAGE PLUS	

SUN MOON STAR GROUP	WATTS LINE: 800.545.4SUN
1941 Ringwood Ave	PAY LINE: 408.452.7811
San Jose CA 95131	FAX LINE:
	BBS LINE:
SUN MOON	

SYQUEST TECHNOLOGY	WATTS LINE:
47923 Warm Springs Blvd.	PAY LINE: 510.226.4000
Fremont CA 94539	FAX LINE:
	BBS LINE: 408.733.4670
SYQUEST	

SYSGEN, Incorporated	WATTS LINE: 800.821.2151
556 Gibraltar Drive	PAY LINE:
Milpitas CA 95035-9868	FAX LINE:
	BBS LINE:
SYSGEN	

TANDON Corporation	WATTS LINE: 800.487.8324
405 Science Drive	PAY LINE: 805.523.0340
Moorpark CA 93021	FAX LINE:
	BBS LINE:
TANDON                    see also WESTERN DIGITAL	

TANDY Corporation	WATTS LINE:
1800 One Tandy Center	PAY LINE: 817.390.3011
Fort Worth TX 76102	FAX LINE:
	BBS LINE:
TANDY	

TEAC AMERICA (DISK PRODUCTS DIV.)	WATTS LINE:
7733 Telegraph Road	PAY LINE: 213.726.0303
Montebello CA 90640	FAX LINE: 213.727.7621
	BBS LINE:
TEAC	

TECMAR	WATTS LINE: 800.624.8560
6225 Cochran Road	PAY LINE: 216.349.0600
Solon OH 44139	FAX LINE:
	BBS LINE:
TECMAR	

MANUFACTURER DIRECTORY

THEREF(tm) Version 4.30

PAGE 26

TEGA TECHNOLOGIES, Incorporated 1040 East Chapman Avenue Orange CA 92666	WATTS LINE: PAY LINE: 714.771.5128 FAX LINE: BBS LINE:
TEGA TECHNOLOGIE now is STORAGE RESEARCH	

TEXAS INSTRUMENTS, Incorporated (no longer offers support)	WATTS LINE: PAY LINE: FAX LINE: BBS LINE:
TEXAS INST.	

TEXEL AMERICA, Incorporated 1080 East Duane Ave., Suite C Sunnyvale CA 94086	WATTS LINE: 800.886.3935 PAY LINE: 408.736.1374 FAX LINE: 408.736.1378 BBS LINE:
TEXEL	

TOSHIBA, DISK PRODUCTS DIV. 9740 Irvine Blvd, PO Box 19724 Irvine CA 92713-9724	WATTS LINE: 800.456.DISK PAY LINE: 714.583.3000 FAX LINE: 714.583.3133 BBS LINE: 714.837.4408
TOSHIBA	

TRADEWINDS PERIPHERALS, Inc. 2633 East 28th Street Long Beach CA 90806	WATTS LINE: PAY LINE: 213.595.7272 FAX LINE: 213.595.6446 BBS LINE:
TRADEWINDS	

TRANTOR SYSTEMS, Ltd. 5415 Randall Place Fremont CA 94538	WATTS LINE: PAY LINE: 415.770.1400 FAX LINE: BBS LINE:
TRANTOR SYSTEMS	

TRISTAR TECHNOLOGY, Inc. 10 Reuten Drive Closter NJ 07624	WATTS LINE: PAY LINE: 201.784.1557 FAX LINE: BBS LINE:
TRISTAR	

TULIN Corporation 2156 O'Toole Avenue San Jose CA 95131	WATTS LINE: PAY LINE: 408.432.9025 FAX LINE: 408.943.0782 BBS LINE:
TULIN	



MANUFACTURER DIRECTORY

THEREF (tm) Version 4.30

PAGE 27

U.S. DESIGN (MAXTOR) WATTS LINE:  
 4311 Forbes Blvd. PAY LINE: 301.577.2880  
 Lanham MD 20706 FAX LINE:  
 BBS LINE:

US DESIGN see also MAXTOR

ULTRASTOR Corporation WATTS LINE:  
 15 Hammond, Suite 310 PAY LINE: 714.581.4100  
 Irvine CA 92718 FAX LINE: 714.581.0826  
 BBS LINE: 714.256.5033

ULTRASTOR TECH#:510.623.8955, BBS:510.623.9091

VERTEX WATTS LINE: OUT  
 PAY LINE: OF  
 FAX LINE: BUSINESS  
 BBS LINE:

VERTEX OUT OF BUSINESS ... See also PRIAM

WESTERN DIGITAL Corp. WATTS LINE: 800.832.4778  
 2445 McCabe Way PAY LINE: 714.863.0102  
 Irvine CA 92714 FAX LINE: 714.863.1656  
 BBS LINE: 714.753.1234

WESTERN DIG. 9600 BBS:714.753.1068

WINCHESTER SYSTEMS, Inc. WATTS LINE:  
 Woburn MA PAY LINE: 617.933.8500  
 FAX LINE:  
 BBS LINE:

WINCHESTER SYS.

XEBEC WATTS LINE:  
 3579 Gordon PAY LINE:  
 Carson City NV 89701 FAX LINE:  
 BBS LINE:

XEBEC

XEBEC AMERICA WATTS LINE:  
 CA PAY LINE:  
 FAX LINE: 408.435.2653  
 BBS LINE:

XEBEC AMERICA

XYXIS Corporation WATTS LINE:  
 14631 Martin Drive PAY LINE: 612.949.2388  
 Eden Prairie MN 55344 FAX LINE:  
 BBS LINE:

XYXIS

MANUFACTURER DIRECTORY

THEREF(tm) Version 4.30

PAGE 28

ZETACO Incorporated  
6850 Shady Oak Road  
Eden Prairie MN 55344

WATTS LINE:  
PAY LINE: 612.941.9480  
FAX LINE:  
BBS LINE:

ZETACO

## CONTRIBUTORS

James Zapetis  
Rich Greene  
Donald Mangold  
Mike O'Toole  
Jan Ceuleers  
Norman Sturdevant  
Lance Williams  
Joseph Aquino  
David Ellison  
Bill Drake  
Michael Stanton  
William Ellis  
Maoee Tsen  
Rog Virta  
Doug Gormley  
Jim Condon  
Jon Mortensen  
Mike Focke  
Doug Wagner  
John Hunt  
Bill Wunsch  
Steven Case

